

Yealink



Ultra-elegant Gigabit IP Phone SIP VP-T49G User Guide

Version 80.100
Jul. 2016

Copyright

Copyright © 2016 YEALINK(XIAMEN) NETWORK TECHNOLOGY CO., LTD.

Copyright © 2016 Yealink(Xiamen) Network Technology CO., LTD. All rights reserved. No parts of this publication may be reproduced or transmitted in any form or by any means, electronic or mechanical, photocopying, recording, or otherwise, for any purpose, without the express written permission of Yealink(Xiamen) Network Technology CO., LTD. Under the law, reproducing includes translating into another language or format.

When this publication is made available on media, Yealink(Xiamen) Network Technology CO., LTD. gives its consent to downloading and printing copies of the content provided in this file only for private use but not for redistribution. No parts of this publication may be subject to alteration, modification or commercial use. Yealink(Xiamen) Network Technology CO., LTD. will not be liable for any damages arising from use of an illegally modified or altered publication.

Warranty

THE SPECIFICATIONS AND INFORMATION REGARDING THE PRODUCTS IN THIS GUIDE ARE SUBJECT TO CHANGE WITHOUT NOTICE. ALL STATEMENTS, INFORMATION, AND RECOMMENDATIONS IN THIS GUIDE ARE BELIEVED TO BE ACCURATE AND PRESENTED WITHOUT WARRANTY OF ANY KIND, EXPRESS OR IMPLIED. USERS MUST TAKE FULL RESPONSIBILITY FOR THEIR APPLICATION OF PRODUCTS.

YEALINK(XIAMEN) NETWORK TECHNOLOGY CO., LTD. MAKES NO WARRANTY OF ANY KIND WITH REGARD TO THIS GUIDE, INCLUDING, BUT NOT LIMITED TO, THE IMPLIED WARRANTIES OF MERCHANTABILITY AND FITNESS FOR A PARTICULAR PURPOSE. Yealink(Xiamen) Network Technology CO., LTD. shall not be liable for errors contained herein nor for incidental or consequential damages in connection with the furnishing, performance, or use of this guide.

Declaration of Conformity

 Hereby, Yealink(Xiamen) Network Technology CO., LTD. declares that this phone is in conformity with the essential requirements and other relevant provisions of the CE, FCC.

You can find the CE and FCC information from the label on the back of the IP phone.

Statements of compliance can be obtained by contacting support@yealink.com.

CE Mark Warning

This device is marked with the CE mark in compliance with R&TTE Directive 1999/5/EC.

Part 15 FCC Rules

Any changes or modifications not expressly approved by the party responsible for compliance could void the user's authority to operate the equipment.

This device complies with Part 15 of the FCC Rules. Operation is subject to the following two conditions:

1. This device may not cause harmful interference, and
2. this device must accept any interference received, including interference that may cause undesired operation.

Class B Digital Device or Peripheral

Note: This equipment has been tested and found to comply with the limits for a Class B digital device, pursuant to part 15 of the FCC Rules. These limits are designed to provide reasonable protection against harmful interference in a residential installation. This equipment generates, uses and can radiate radio frequency energy and, if not installed and used in accordance with the instructions, may cause harmful interference to radio communications. However, there is no guarantee that interference will not occur in a particular installation. If this equipment does cause harmful interference to radio or television reception, which can be determined by turning the equipment off and on, the user is encouraged to try to correct the interference by one or more of the following measures:

1. Reorient or relocate the receiving antenna.
2. Increase the separation between the equipment and receiver.
3. Connect the equipment into an outlet on a circuit different from that to which the receiver is connected.
4. Consult the dealer or an experienced radio/TV technician for help.

WEEE Warning



To avoid the potential effects on the environment and human health as a result of the presence of hazardous substances in electrical and electronic equipment, end users of electrical and electronic equipment should understand the meaning of the crossed-out wheeled bin symbol. Do not dispose of WEEE as unsorted municipal waste and have to collect such WEEE separately.

Customer Feedback

We are striving to improve our documentation quality and we appreciate your feedback. Email your opinions and comments to DocsFeedback@yealink.com.

GNU GPL INFORMATION

Yealink SIP VP-T49G IP phone firmware contains third-party software under the GNU General Public License (GPL). Yealink uses software under the specific terms of the GPL. Please refer to the GPL for the exact terms and conditions of the license.

The original GPL license, source code of components licensed under GPL and used in Yealink products can be downloaded online:

<http://www.yealink.com/GPLOpenSource.aspx?BaseInfoCatId=293&NewsCatId=293&CatId=293>.

About This Guide

Thank you for choosing the SIP VP-T49G IP phone, an ultra-elegant gigabit IP phone which is exquisitely designed to provide business telephony features, such as Call Hold, Call Transfer, Busy Lamp Field, Call Recording, Multicast Paging and Conference over an IP network. It also features an enhanced user experience and newly developed industrial design, with a large touch screen for easy and efficient use.

This guide provides everything you need to quickly use your new phone. First, verify with your system administrator that the IP network is ready for phone configuration. Also be sure to read the Packaging Contents and Regulatory Notices sections in this guide before you set up and use the SIP VP-T49G IP phone.

Note

Network Directory and Network Call Log features are hidden for IP phones in neutral firmware, which are designed for the BroadWorks environment. Please contact your system administrator for more information.

In This Guide

Topics provided in this guide include:

- Chapter 1 [Overview](#)
- Chapter 2 [Getting Started](#)
- Chapter 3 [Customizing Your Phone](#)
- Chapter 4 [Basic Phone Features](#)
- Chapter 5 [Advanced Phone Features](#)

Summary of Changes

This section describes the changes to this guide for each release and guide version.

Changes for Release 80, Guide Version 80.100

The following section is new:

- [Power Saving](#) on page 66

Major updates have occurred to the following sections:

- [Icon Instructions](#) on page 15
- [Web User Interface](#) on page 22

- [Using the Phone Keypad and Dial Pad](#) on page 44
- [Screen Saver](#) on page 64
- [Volume](#) on page 78
- [Ring Tones](#) on page 80
- [Display Issues](#) on page 285

Changes for Release 80, Guide Version 80.75

The following section is new:

- [Shared Call Appearance \(SCA\)](#) on page 257

Major updates have occurred to the following sections:

- [Icon Instructions](#) on page 15
- [Documentations](#) on page 24
- [Packaging Contents](#) on page 27
- [Phone Installation](#) on page 29
- [Entering Data and Editing Fields](#) on page 41
- [Local Directory](#) on page 82
- [Blacklist](#) on page 102
- [Remote Phone Book](#) on page 104
- [Bluetooth Headset](#) on page 117
- [Bluetooth-Enabled Mobile Phone](#) on page 123
- [Call Forward](#) on page 192
- [Call Transfer](#) on page 202
- [Voice Mail/Video Voice Mail](#) on page 278
- [Call Issues](#) on page 287

Table of Contents

About This Guide	v
In This Guide	v
Summary of Changes	v
Changes for Release 80, Guide Version 80.100	v
Changes for Release 80, Guide Version 80.75	vi
Table of Contents	vii
Overview	13
Hardware Component Instructions	13
Icon Instructions	15
LED Instructions	21
User Interfaces	22
Phone User Interface	22
Web User Interface	22
Documentations	24
Getting Started	27
Packaging Contents	27
Optional Accessories	29
Phone Installation	29
Network Connection	32
Connecting to the Wired Network	33
Connecting to the Wireless Network	33
Phone Initialization	33
Registration	34
Touch Screen Display	34
Idle Screen Display	34
Configuration Screen Display	36
Video Call Screen Display	37
Video Call Full-Screen Display (Both Far- and Near-Site Videos Exist)	38
Navigating Menus and Fields	39
Gestures	39
Control Center/Notification Center	40
Entering Data and Editing Fields	41
Using the Onscreen Keyboard	41

Using the Phone Keypad and Dial Pad	44
Phone Status	46
Basic Network Settings	47
Wireless Network Settings	50
Connecting to the Wireless Network	50
Disconnecting the Wireless Network Connection	56
Viewing the Wireless Network Information	57
Managing the Saved Wireless Network	58
Disabling Wi-Fi Feature	59
Customizing Your Phone	61
General Settings	61
Wallpaper	61
Screen Saver	64
Power Saving	66
Backlight	68
Language	69
Time & Date	71
Administrator Password	73
Key as Send	74
Phone Lock	75
Audio Settings	78
Volume	78
Ring Tones	80
Contact Management	82
Local Directory	82
Blacklist	102
Remote Phone Book	104
Mobile Contacts	106
Call History Management	109
Viewing History Records	109
Deleting History Records	111
Disabling History Records	114
System Customizations	115
Headset Use	115
Bluetooth Headset	117
Bluetooth-Enabled Mobile Phone	123
DSS Keys	130
Account Management	141
Dial Plan	146
Emergency Number	151
Live Dialpad	152
Hotline	153

Basic Phone Features155

Placing Calls	156
Answering Calls	158
Ending Calls	161
Changing Video Call Settings	161
Stopping Transmitting Video during a Call	161
Changing the Clarity of Near-Site Video	162
Changing the Video Settings	168
Changing the Video Layout during Calls	169
Previewing the Near-Site Video	174
External Monitor	175
Redialing Numbers	178
Recent Call In Dialing	178
Auto Answer	179
Auto Redial	180
Call Completion	182
Recall	184
Call Mute	184
Call Hold/Resume	185
Do Not Disturb (DND)	187
Call Forward	192
Static Forwarding	192
Dynamic Forwarding	201
Call Transfer	202
Blind Transfer	202
Semi-Attended Transfer	203
Attended Transfer	204
Call Waiting	205
Conference	206
Local Conference	206
Network Conference	209
Call Park	210
Call Pickup	211
Anonymous Call	215
Anonymous Call Rejection	216
Capturing Screenshots during a Video Call	218
Viewing the Pictures Stored in Your USB Flash Drive	221

Advanced Phone Features.....223

Busy Lamp Field (BLF)	223
Configuring the BLF Feature on the Phone	223
Using BLF Feature on the Phone	228

BLF List	230
Call and Conference Recording Using a USB Flash Drive	232
Call Recording	233
Conference Recording	235
Recorded Calls Playback	235
Storage Space	238
Call Recording Using a Record Key	239
Hot Desking	241
Intercom	243
Outgoing Intercom Calls	244
Incoming Intercom Calls	244
Using Intercom	246
Multicast Paging	247
Sending RTP Stream	247
Receiving RTP Stream	251
Using Multicast Paging	252
Music on Hold	254
Automatic Call Distribution (ACD)	255
Shared Call Appearance (SCA)	257
Configuring SCA Feature on the IP Phone	258
Using SCA Feature on the IP Phone	265
Messages	274
Short Message Service (SMS)	274
Voice Mail/Video Voice Mail	278
Message Waiting Indicator (MWI)	281
Troubleshooting	285
General Issues	285
Display Issues	285
Password Issues	286
Call Issues	287
Headset & Handset Issues	287
Audio Issues	288
Video Issues	291
Recording Issues	292
Log Issues	292
Reboot & Upgrade & Reset Issues	294
Regulatory Notices	299
Service Agreements	299
Limitations of Liability	299
Safety Instructions	299

Appendix A - Time Zones.....301

Index.....303

Overview

This chapter provides the overview of the SIP VP-T49G IP phone. Topics include:

- [Hardware Component Instructions](#)
- [Icon Instructions](#)
- [LED Instructions](#)
- [User Interfaces](#)
- [Documentations](#)

If you require additional information or assistance with your new phone, contact your system administrator.

Hardware Component Instructions

The main hardware components of the SIP VP-T49G IP phone are the touch screen and the keypad.

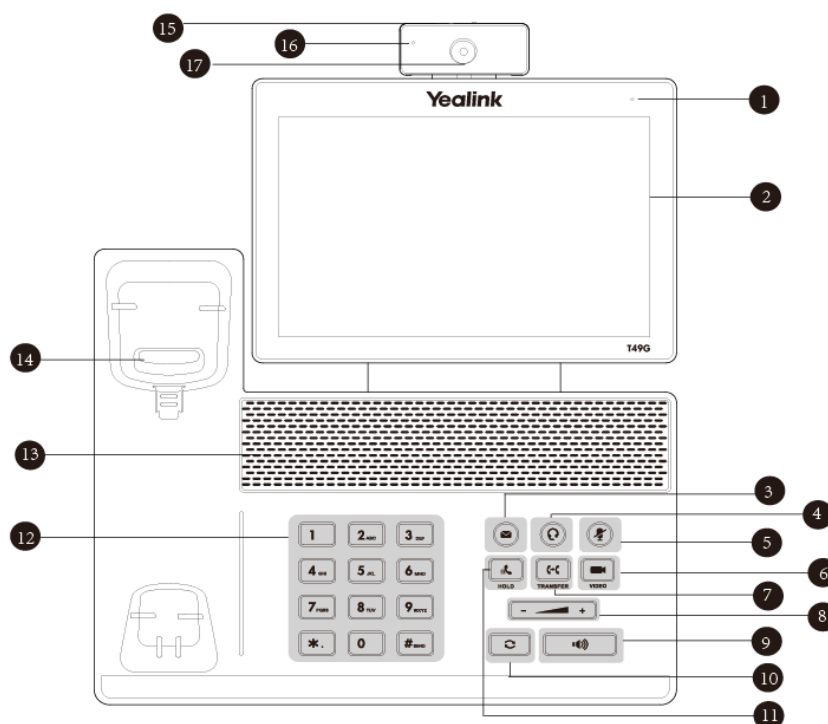

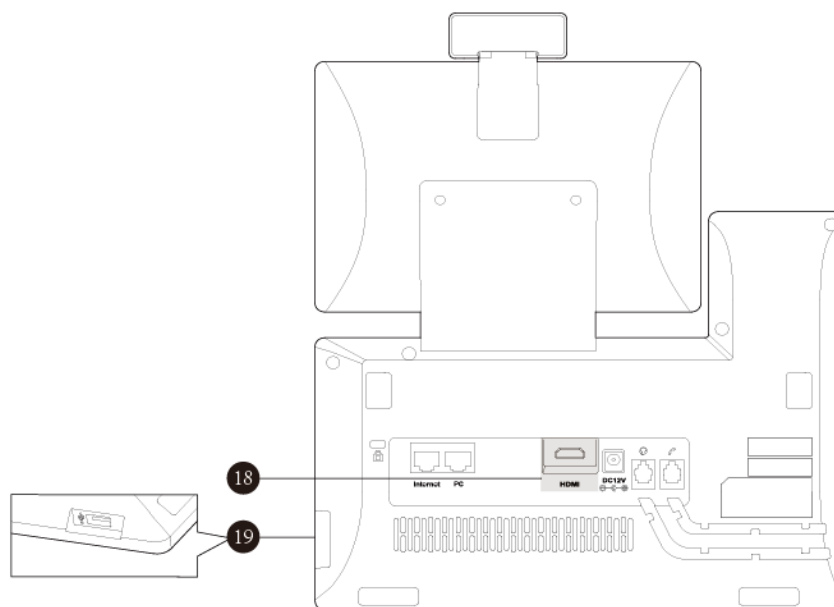



Hardware component instructions of the SIP VP-T49G IP phone are:





















	Item	Description
①	Power Indicator LED	Indicates phone power and some feature statuses. <ul style="list-style-type: none"> • Receives an incoming call—Fast flashing • Receives a voice mail or text message—Slow flashing
②	Touch Screen	The screen is touch-sensitive. Tap to select and highlight screen items. Shows information about calls, messages, soft keys, time, date and other relevant data: <ul style="list-style-type: none"> • Call information—caller ID, call duration • Icons (for example, ) • Missed call list or second incoming caller information • Prompt text (for example, "Save succeeded!") • Time and date
③	MESSAGE Key	<ul style="list-style-type: none"> • Indicates and accesses voice mails. The key LED illuminates solid green when one or more voice mails are waiting at the message center. • Captures screenshots during a video call.
④	HEADSET Key	Allows you to place and receive calls through an optionally connected headset. The key LED illuminates solid green when headset mode is activated.
⑤	MUTE Key	Mutes audio transmission locally during calls and conferences. The key LED illuminates solid red when the call is muted.
⑥	VIDEO Key	<ul style="list-style-type: none"> • Allows you to preview near-site video when the phone is idle. • Controls the transmission of video images during calls





















	Item	Description
		and conferences.
⑦	TRANSFER Key	Transfers a call to another party.
⑧	Volume Key	Adjusts the volume of the handset, headset, speakerphone or ringer.
⑨	Speakerphone Key	Toggles the hands-free speakerphone mode. The key LED illuminates solid green when the speakerphone mode is activated.
⑩	REDIAL Key	Redials a previously dialed number.
⑪	HOLD Key	Places a call on hold or resumes a held call.
⑫	Keypad	Provides the digits, letters and special characters in context-sensitive applications.
⑬	Speaker	Provides hands-free (speakerphone) audio output.
⑭	Hookswitch	<ul style="list-style-type: none"> • Picking up the handset from the handset cradle, the hookswitch bounces and the phone connects to the line. • Laying the handset down on the handset cradle, the phone disconnects from the line.
⑮	Shutter Switch	Covers and uncovers the camera.
⑯	Camera Indicator LED	<p>Indicates camera and some feature statuses.</p> <ul style="list-style-type: none"> • Receives a video call—Flashing green • Receives an audio-only call—Solid green
⑰	Camera Lens	Provides near-site video. The better distance between camera and images you want to capture should be in the range of 0.35 meters (1 foot) to 2 meters (6 feet).
⑱	HDMI port	Allows you to connect an external monitor (optional) to your phone and the video image captured from camera (both near site and far site) will also be shown on the external monitor during a video call.
⑲	USB2.0 port	Allows you to connect a USB flash drive (optional) to your phone so you can display pictures on your phone, capture screenshot, and record and play back calls.

Icon Instructions





















Icons appearing on the touch screen are described in the following table:















Icons	Description
	Wired network is unavailable
	The private line registers successfully

Icons	Description
	Register failed
 (Flashing)	Registering
	The shared line registers successfully
	Hands-free speakerphone mode
	Handset mode
	Headset mode
	Voice Mail
	Text Message
	Auto Answer
	Do Not Disturb
	Camera is not detected
	Call Hold (video)
	Call Hold (audio-only)
	Call Forward
	Call Mute
	Ringer volume is 0
	Phone Lock
	Received Calls
	Placed Calls
	Missed Calls



Icons	Description
	Forwarded Calls
	Recording box is full
	A call cannot be recorded
	Recording starts successfully
	Recording cannot be started
	Recording cannot be stopped
	Bluetooth mode is on
	Bluetooth headset is both paired and connected
	Bluetooth-Enabled mobile phone is both paired and connected
	The default caller photo and contact icon
	The default mobile caller photo and mobile contacts icon
	Wi-Fi mode is on
	Wi-Fi is connected successfully and the signal strength is strong
	Wi-Fi is connected successfully and the signal strength is high
	Wi-Fi is connected successfully and the signal strength is middle
	Wi-Fi is connected successfully and the signal strength is weak
	Wi-Fi fails to connect
	The USB flash drive is detected
	DSS Key
	External monitor is connected





The icons of DSS key appearing on the touch screen are described in the following table:

Icons	Description
	ACD (Log into the ACD system)
	ACD (The ACD status is available)
	ACD (The ACD status is unavailable)
	ACD (Log out of the ACD system)
	Voice Mail
	Direct Pickup
	Group Pickup
	Call Park (Park successfully; Call park idle state)
	Call Park (Park failed)
	Call Park (Call park ringing state)
	Intercom
	DTMF Prefix
	Local Group XML Group
	XML Browser
	LDAP
	Conference
	Forward
	Transfer
	Hold
	DND

Icons	Description
	ReCall
	SMS
	Record/URL Record
	Record/URL Record (Recording starts successfully)
	Multicast Paging Group Listening Paging List
	Hot Desking
	Zero Touch
	URL
	Phone Lock
	Directory
	Speed Dial
	Mobile Line (Bluetooth-Enabled mobile phone is both paired and connected)
	Mobile Line (Bluetooth-Enabled mobile phone fails to connect)
 (Flashing)	Mobile Line (Bluetooth-Enabled mobile phone is connecting)









Icon indicator (associated with BLF/BLF List)

Icons	Description
	BLF/BLF list idle state
 (Flashing)	BLF/BLF list ringing state
 (Flashing)	BLF/BLF list callout state

Icons	Description
	BLF/BLF list talking state
	BLF hold state
	BLF list call park state
	BLF/BLF list failed state

Icon indicator (associated with a shared line)

The local SCA phone indicates the phone is involved in an SCA call, while the monitoring SCA phone indicates the phone is not involved in the SCA call.

Icon	Description
	The shared line is idle.
 (for monitoring SCA phone)	The shared line is seized.
 (Flashing)	The shared line receives an incoming call.
 (Flashing)	The shared line is dialing.
	The shared line is in conversation.
	The shared line conversation is placed on public hold.
 (for local SCA phone)  (for monitoring SCA phone)	The shared line conversation is placed on private hold.
	The shared line conversation is barged in by the other shared line party.

Icon	Description
	For a multi-party call, all the shared line parties participating in this call place the shared line conversation on hold.

LED Instructions

Power Indicator LED

LED Status	Description
Solid red	The phone is initializing.
Fast flashing red	The phone is ringing.
Slow flashing red	The phone receives a text message/voice mail/video voice mail.
Off	The phone is powered off. The phone is idle. The phone is busy. The call is placed on hold or is held. The call is muted.

Camera Indicator LED

LED Status	Description
Solid green	The phone is powered on and the camera is properly connected to the phone. The camera is idle. The phone receives an audio-only call.
Flashing green	The phone receives a video call.
Solid red	There is an active video call. The video call is muted. The video call is held.
Slow flashing red	The shutter switch is open, but the near-site video is stopped transmitting during a video call. The video call is placed on hold.
Off	The phone is powered off. The camera is not properly connected to the phone. The shutter switch is closed.

Note

The above introduces the default power indicator LED status. The status of the power indicator LED is configurable via web user interface. For more information, refer to [Yealink_SIP-T2_Series_T19\(P\)_E2_T4_Series_CP860_IP_Phones_Administrator_Guide](#).

User Interfaces

Two ways to customize configurations of your SIP VP-T49G IP phone:

- The user interface on the IP phone.
- The user interface in a web browser on your PC.

The hardware components keypad and touch screen constitute the phone user interface, which allows the user to execute all call operation tasks and basic configuration changes directly on the phone. In addition, you can use the web user interface to access all configuration settings. In many cases, it is possible to use either the phone user interface and/or the web user interface interchangeably. However, in some cases, it is only possible to use one or the other interface to operate the phone and change settings.

Phone User Interface

You can customize your phone by tapping  to access the phone user interface. The **Advanced** option is only accessible to the administrator, and the default administrator password is “admin” (case-sensitive). For more information on customizing your phone with the available options from the phone user interface, refer to [Customizing Your Phone](#) on page 61.

Web User Interface

In addition to the phone user interface, you can also customize your phone via web user interface. In order to access the web user interface, you need to know the IP address of your new phone. To obtain the IP address, tap  -> **Status** on the phone when the phone is idle. Enter the IP address (e.g., http://192.168.0.10 or 192.168.0.10 for IPv4; http://[2005:1:1:1:215:65ff:fe64:6e0a] or [2005:1:1:1:215:65ff:fe64:6e0a] for IPv6) in the address bar of a web browser on your PC. The default administrator user name and password are both “admin” (case-sensitive).

The main options you can use to customize the IP phone via phone user interface and/or via web user interface are listed in the following table:

Options	Phone User Interface	Web User Interface
Status		
--IP Address		
--MAC		
--Firmware	√	√
--Network		
--Phone		
--Accounts		

Options	Phone User Interface	Web User Interface	
Basic Phone Settings			
--Wallpaper	√	√	
--Screen Saver	√		
--Power Saving	x		
--Backlight	√		
--Language	√		
--Time & Date	√		
--Administrator Password	√	√	
--Key as Send	√		
--Phone Lock	√		
--Ring Tones	√		
--Contact Management			
--Local Directory	√		
--Blacklist	√		
--Remote Phone Book	x		
--Mobile Contacts	√		x
--Call History Management	√		√
--Bluetooth Headset	√		
--Bluetooth-Enabled Mobile Phone	√		
--DSS Keys	√		
--Account Registration	√		
--Dial Plan	x		
--Emergency Number	x		
--Live Dialpad	x		
--Hotline	√		
Basic Call Features		√	
--Recent Call In Dialing	x		
--Auto Answer	√		
--Auto Redial	√		
--Call Completion	√		
--ReCall	√		
--Do Not Disturb (DND)	√		
--Call Forward	√		
--Call Transfer	√		
--Call Waiting	√		
--Conference	√		
--Call Park	√		
--Call Pickup	√		
--Anonymous Call	√		
--Anonymous Call Rejection	√		
Advanced Phone Features		√	

Options	Phone User Interface	Web User Interface
--Busy Lamp Field (BLF)	√	
--BLF List	×	
--Call Recording	√	
--Hot Desking	√	
--Intercom	√	
--Multicast Paging	×	
--Music on Hold	×	
--Automatic Call Distribution (ACD)	×	
--Shared Call Appearance (SCA)	×	
--Messages	√	
SIP Account		√
--User Options		√
--Activation	√	
--Label	√	
--Display Name	√	
--Register Name	√	
--User Name	√	
--Password	√	
--Server Options		
--SIP Server1/2	√	
--Register Port	×	
--Outbound Status	√	
--Outbound Proxy1/2	√	
--Proxy Fallback Interval	√	
--NAT Status	√	

Note The table above lists most of the feature options. Please refer to the relevant sections for more information.

Documentations

The following table shows documentations available for the SIP VPT49G IP phone.

Name	Contents	Where found	Language
Quick Start Guide	Basic call features and phone customizations	In the package	English
		On the website	English/Chinese

Name	Contents	Where found	Language
User Guide	Phone/Web user interface settings Basic call features and advanced phone features	On the website	English/Chinese

Note

You can also download the latest documentations online:

<http://support.yealink.com/documentFront/forwardToDocumentDetailPage?documentId=95>.

Getting Started

This chapter provides the following basic installation instructions and information for obtaining the best performance with the SIP VP-T49G IP phone. Topics include:

- [Packaging Contents](#)
- [Phone Installation](#)
- [Network Connection](#)
- [Phone Initialization](#)
- [Registration](#)
- [Touch Screen Display](#)
- [Navigating Menus and Fields](#)
- [Gestures](#)
- [Control Center/Notification Center](#)
- [Entering Data and Editing Fields](#)
- [Phone Status](#)
- [Basic Network Settings](#)
- [Wireless Network Settings](#)

If you require additional information or assistance with your new phone, contact your system administrator.

Packaging Contents

The following components are included in your SIP VP-T49G IP phone package:

- **SIP VP-T49G IP Phone**

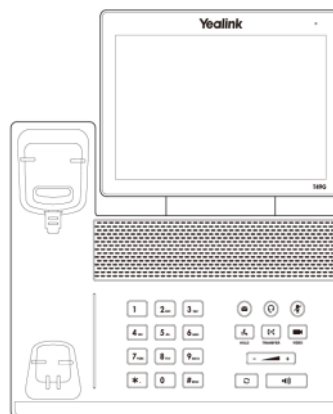

- Phone Stand



- Handset & Handset Cord

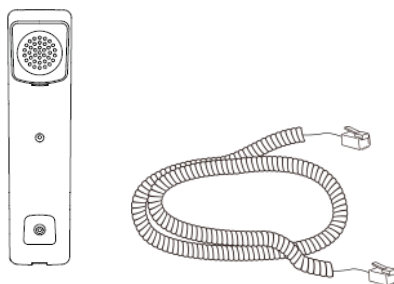

- Camera

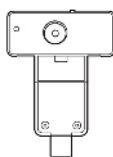

- Ethernet Cable

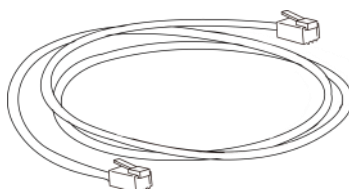

- Quick Start Guide

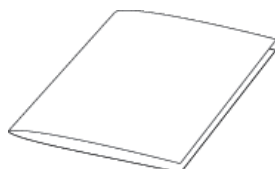

- Power Adapter

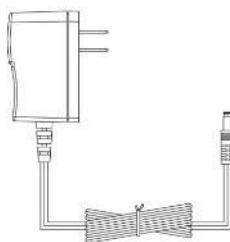

Check the list before installation. If you find anything missing, contact your system administrator.

Optional Accessories

The following items are optional accessories for your SIP VP-T49G IP phone. You need to purchase them separately if required.

- Headset



- Yealink Extended Display Accessories: ED10

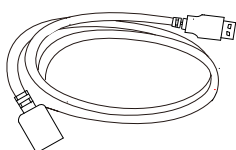

USB3.0 Cable

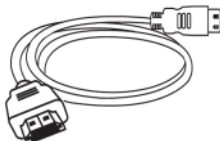

HDMI Cable

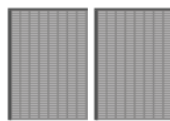

3M Dual Lock ×2

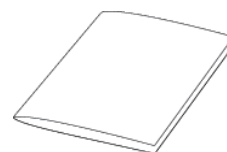

Quick Installation
Guide

Note

We recommend that you use the accessories provided or approved by Yealink. The use of unapproved third-party accessories may result in reduced performance.

Phone Installation

If your phone is already installed, proceed to [Phone Initialization](#) on page 33.

This section introduces how to install the phone:

- 1) Attach the stand
- 2) Insert the camera
- 3) Connect the handset and optional headset
- 4) Connect the AC power
- 5) Connect the optional USB flash drive
- 6) Connect the optional external monitor

1) **Attach the stand**

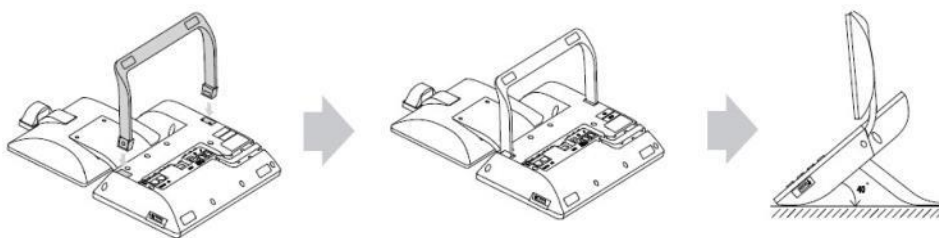

2) **Insert the camera**

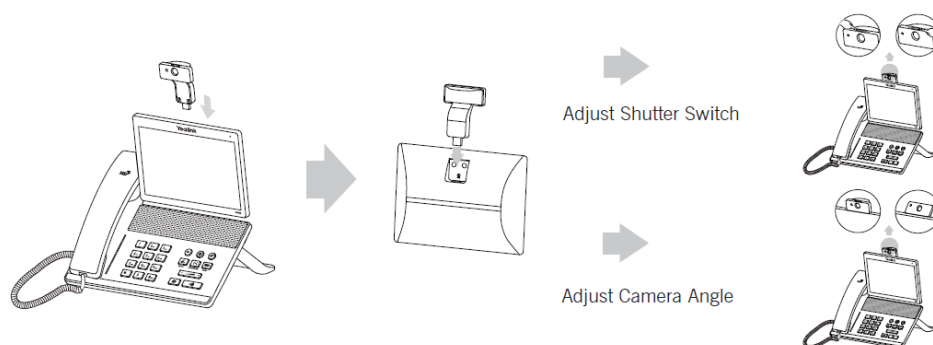

3) **Connect the handset and optional headset**

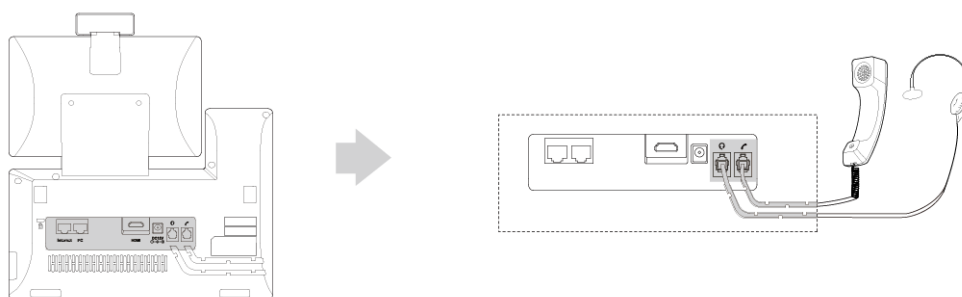

4) Connect the AC power

Connect the DC plug on the power adapter to the DC12V port on the phone and connect the other end of the power adapter into an electrical power outlet.

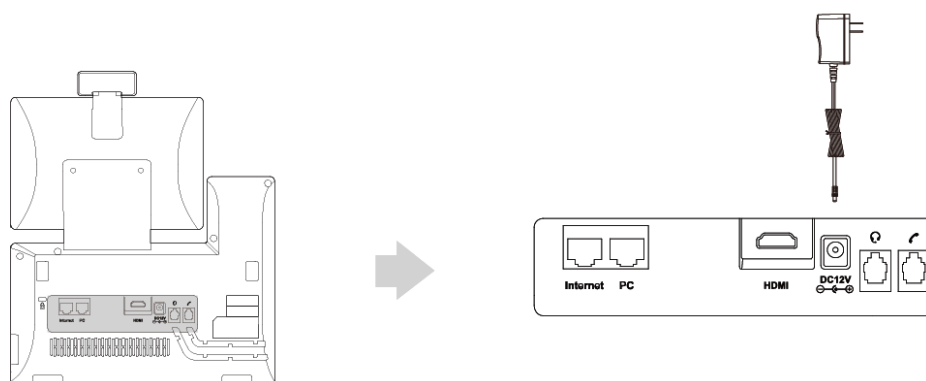



Note

Important! Do not remove power to the phone while it is updating firmware and configurations.

The IP phone should be used with Yealink original power adapter (12V/2A) only. The use of the third-party power adapter may cause the damage to the phone.

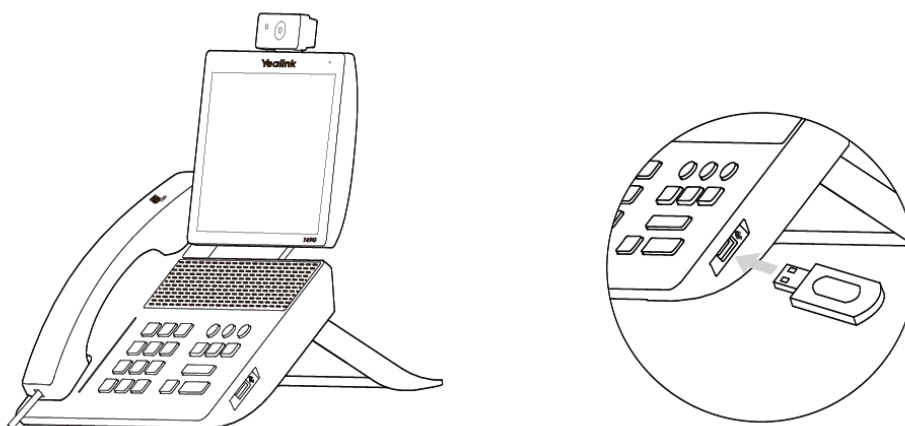
5) Connect the optional USB flash drive



When you attach a USB flash drive to your phone, the icon  will display on the status bar of the touch screen. The flashing icon shows that the phone is detecting the USB flash drive. If the USB flash drive is successfully connected to the phone, the icon  will stop flashing, and the touch screen will prompt "USB device connected successfully!".

Note

The USB flash drive should be purchased separately if required.

6) Connect the optional external monitor

- Remove one piece of the fastener's liner, take the gap of the camera as the touchline and stick it down; connect one end of the USB3.0 cable to the camera.
- Remove the other piece of the fastener's liner and attach to the external monitor; attach the camera to the external monitor by pressing two sides of Dual Lock together. Make sure the camera is vertical and not askew otherwise the near-site video image will be crooked. You are advised to attach the camera to the external monitor whose back is straight.
- Connect the other end of USB3.0 cable to the IP phone.
- Connect one end of the HDMI cable to the HDMI port on the phone, and connect the other end to the HDMI port on the external monitor.

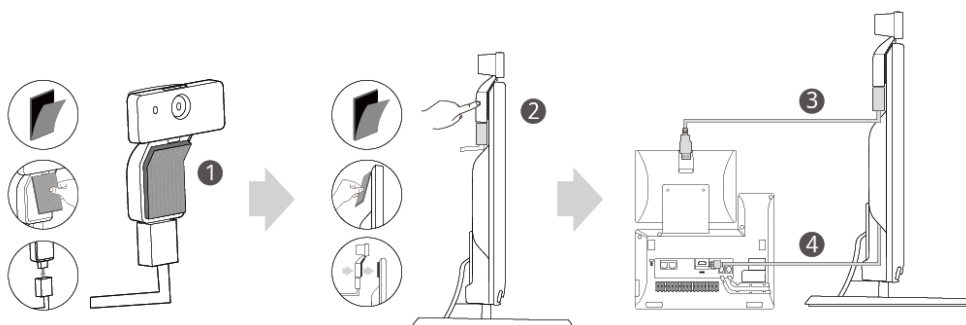

After you connect an external monitor to your phone, the icon  will display on the status bar of the touch screen, and the touch screen will prompt "Ext. Display connected".

Note

You can adjust the camera angle by rotating it up and down, and you have to press on the back of camera to rotate it when you insert the camera to the IP phone.

If you want to insert the camera back to the IP phone and do not torn the 3M Dual Lock, please insert forcibly until the camera indicator LED illuminates solid green. And the embossing on the camera does not need to insert into the groove on the IP phone.

The Extended Display Accessories ED10 which is not included with your IP phone is required for connecting the external monitor. Contact your reseller to purchase it separately. For more information, refer to [Yealink Extended Display Accessories Quick Installation Guide for SIP VP-T49G](#).

Network Connection

You have two options for network connection. You can select one of them according to the current office environment.

- Connecting to the wired network
- Connecting to the wireless network

Connecting to the Wired Network

You can connect your phone to a wired network.

Before connecting your phone to the wired network, it is important to note that the Wi-Fi feature should be disabled. For more information, refer to [Connecting to the Wireless Network](#) on page 33.

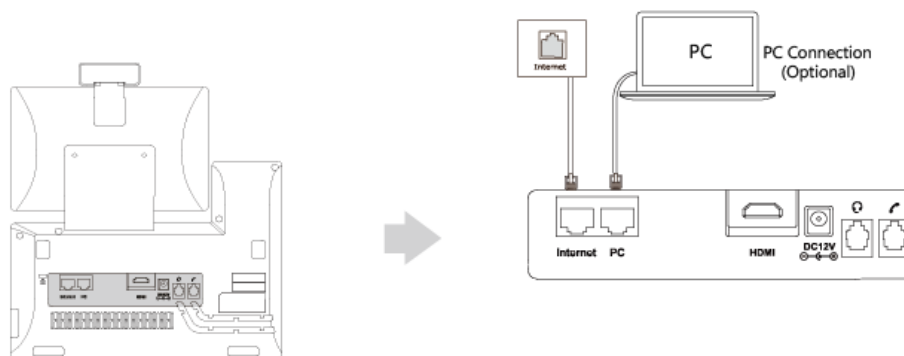

Note The phone can also share the network with another network device such as a PC (personal computer). This is an optional connection. For more information on this function, contact your system administrator.

Connecting to the Wireless Network

Yealink SIP VP-T49G IP phone supports Wi-Fi feature. You can connect your phone to a wireless network. The wireless network is more convenient and cost-effective than wired network. The PC port is not supported in wireless network. For more information on how to connect to a wireless network, refer to [Wireless Network Settings](#) on page 50.

Phone Initialization

After your phone is powered on, the system boots up and performs the following steps:

Automatic Phone Initialization

The phone finishes the initialization by loading the saved configuration. The touch screen displays "Welcome Initializing...Please wait" during the initialization.

DHCP (Dynamic Host Configuration Protocol)

The phone attempts to contact a DHCP server in your network to obtain valid IPv4 network settings (e.g., IP address, subnet mask, default gateway address and DNS address) by default.

Note If your network does not use DHCP, proceed to [Basic Network Settings](#) on page 47.

Registration

Generally, your phone will be deployed with multiple other phones. In this case, your system administrator will configure the phone parameters beforehand, so that after you start up your phone, the phone will be registered and ready for use. The SIP VP-T49G IP phone supports up to 16 accounts. If your phone is not registered, you may have to register it. For more information on how to register your phone, refer to [Account Management](#) on page 141.





Touch Screen Display

Idle Screen Display

If the phone has successfully started up, the idle screen will be displayed. The following figure is an example of what is displayed on the touch screen.





No.	Name	Description
1	Status Bar	Displays the phone's default account and icons.

No.	Name	Description
2	Icons	Icons are displayed in the middle of the status bar. For more information, refer to Icon Instructions on page 15.
3	Default Account	The label of the default account is displayed on the left of the status bar. If multiple accounts are already registered, tap and select the desired default account. For more information, refer to the default account on page 143.
4	Line Keys (1-11)	The idle screen displays line keys 1-11. The line keys 1-6 on the left and the line keys 7-11 on the right can be used to activate up to 11 lines. Various features can be assigned to line keys. Each line key can display the label and indicate the status of the assigned feature.
5	DSS Key	Provides a quick access to the line key screen. Then, you can tap the desired line key to configure it.
6	Wallpaper	Shows the specified wallpaper, which can be customized. For more information, refer to Wallpaper on page 61.
7	Shortcut Keys	 : tap this shortcut key to enter the History screen and view call history.  : tap this shortcut key to enter the Directory screen and view contacts.  : tap this shortcut key to toggle the DND mode or enter the custom DND configuration screen.  : tap this shortcut key to enter the main menu.
8	Time and Date	The phone's time and date are displayed in the center of the idle screen.

Configuration Screen Display



No.	Name	Description
1	Title Area	Displays the title of the current menu screen.
2	Default Account	Displays the label of the default account. If multiple accounts are already registered, tap and select the desired default account. For more information, refer to Account Registration
3	Operation Option Area	Displays various operation options for different menu screens.
4	Menu Tree Area	Displays menu items. Tap the desired menu item to enter the corresponding configuration screen.
5		Go back to the previous menu.
6	Soft Keys	Label automatically to identify their context-sensitive features.
7		Return to the idle screen.
8	Configuration Area	Displays configuration items of the highlighted menu item in the menu tree area.
9	Time and Date	The phone's time and date are displayed on the right of the status bar.

Video Call Screen Display



No.	Name	Description
1	Time and Date	The phone's time and date are displayed on the right of the status bar.
2	Line Keys (1-11)	The video call screen displays line keys 1-11. The line keys 1-6 on the left and the line keys 7-11 on the right can be used to activate up to 11 lines. Various features can be assigned to line keys. Each line key can display the label and indicate the status of the assigned feature.
3	DSS Key	Provides a quick access to the line key screen. Then, you can tap the desired line key to configure it.
4		Displays the video on the full screen. The near-site and far-site videos only display, but the other areas are hidden. For more information on this screen display, refer to Video Call Full-Screen Display (Both Far- and Near-Site Videos Exist) on page 38.
5	Soft Keys	Label automatically to identify their context-sensitive features.
6	Far-Site Information	Shows the information (name or number) of the far site by default.
7	Call Duration Timer	Shows the duration time of current call.

No.	Name	Description
8	Active Call Window	Displays the active call. During a video call, the active call window can display the near site and the far site. By default, a small window (near site) is located on the top-right of the touch screen, and a larger window (far site) is centered in the middle of the touch screen.
9	Talking Mode	Shows that you are talking using the handset, speakerphone or headset. You can alternate among the three modes during calls.

Video Call Full-Screen Display (Both Far- and Near-Site Videos Exist)

From the video call screen, do one of the following to view full-screen video:

- Tap the big size image.
- Tap  .
- The phone will enter this screen automatically within 5 seconds during a call.

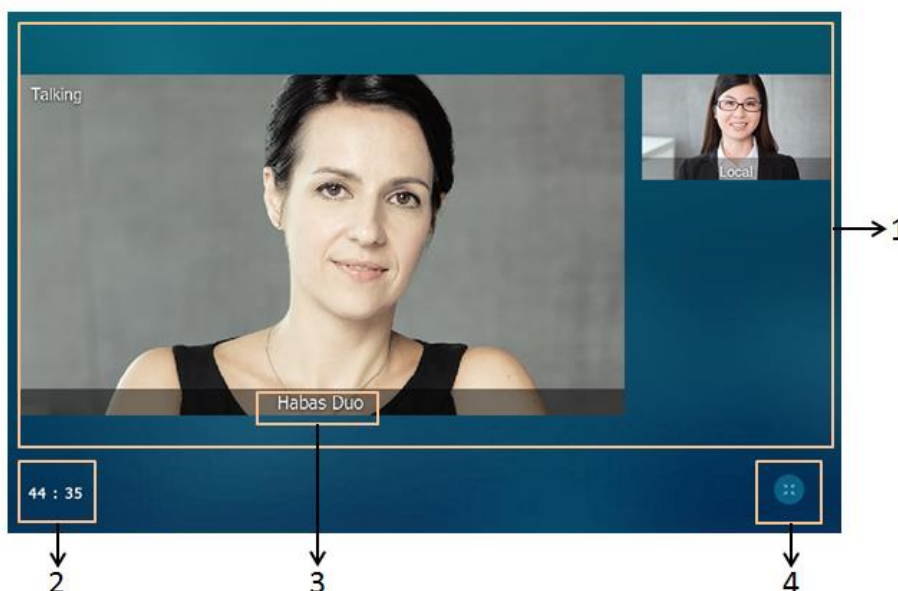

No.	Name	Description
1	Video Display Area	Shows video in different layout.
2	Call Duration Timer	Shows the duration time of current call.

No.	Name	Description
3	Far-Site Information	Shows the information (name or number) of the far site by default.
4		Exits the full-screen display.

Navigating Menus and Fields



To navigate menus and fields, you can:

- Tap corresponding keys on the touch screen.
- Tap menu items, fields, and arrows on the touch screen.
- Press keys on the phone keypad.

Note

The menu system will automatically exit to the idle screen after 60 seconds of inactivity.





To operate your phone, follow these tips:

If you want to	Action
Enter the main menu.	Tap  .
Return to the idle screen.	Tap  .
Go back to the previous menu.	Tap  .
Select an item.	Tap the item.
Scroll through items page by page.	Drag up and down to scroll. (You can wait for the scrolling to come to a stop, or touch the screen to stop it immediately.)
Scroll through values for a field.	Drag up and down to scroll through values.
Select a value for a field.	Tap the value or scroll to the value in the pop-up dialog box.

Gestures

To operate your phone using gestures, follow these tips:

Gesture	Action
Tap 	Touch an item on the screen with your finger, and then lifting your finger.

Gesture		Action
Swipe		Tap and move. When you want to scroll quickly, swipe your finger across the screen, either up, down, left or right.
Drag		Touch and hold, then move. To stop scrolling, stop the dragging motion.
Pinch Open		Touch the screen with two or more fingers, and then move the fingers away from each other (stretch).
Pinch Close		Touch the screen with two or more fingers, and then move the fingers towards each other (pinch).



Control Center/Notification Center

Control center or notification center allows you to access to common features or view important notifications quickly.

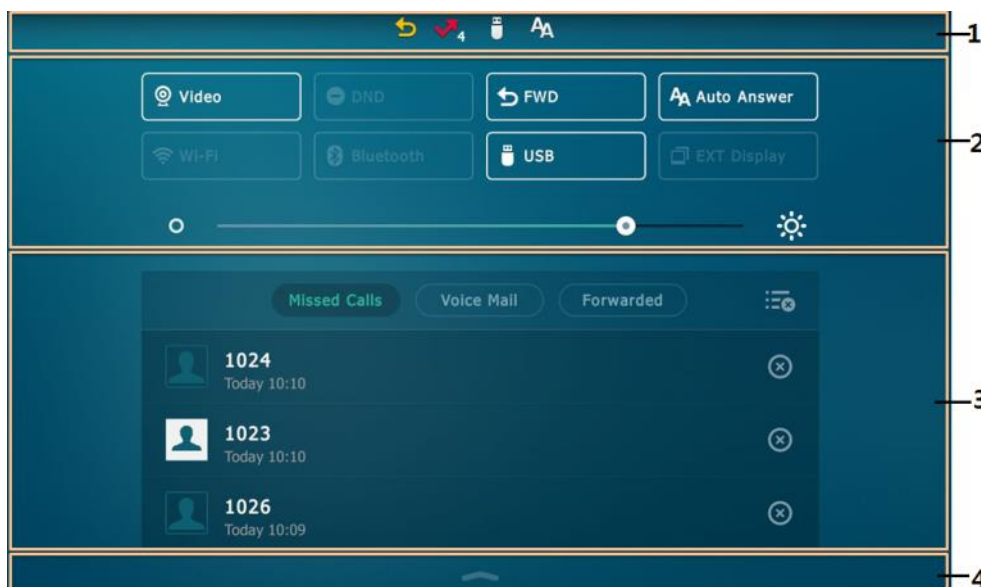
Swipe down from the top of the screen to enter the control center and the notification center:



No.	Name	Description
1	Status Bar	Displays icon to indicate a certain feature status, such as call forward, is enabled.

No.	Name	Description
2	Control Center	<ul style="list-style-type: none"> To turn on/off common features quickly, tap corresponding icons. To adjust the screen brightness.
3	Notification Center	<ul style="list-style-type: none"> To view the list of miss calls, voice mail, forwarded calls quickly. To delete all records, tap . To delete a specific record, tap .
4		Tap it or swipe up from the bottom of the screen to hide this screen.

Entering Data and Editing Fields

SIP VP-T49G IP phone provides onscreen keyboard, phone keypad and dial pad to enter data. Keypad and dial pad provides standard key layout, which enables users to use existing or familiar key positions. You can enter data and edit fields using the onscreen keyboard, phone keypad or dial pad.



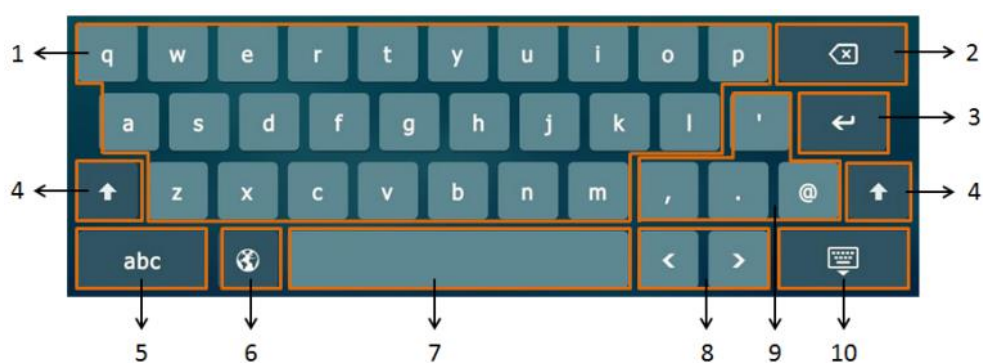

Using the Onscreen Keyboard

Before using the onscreen keyboard to enter data, you need to know the function of the keys on the onscreen keyboard.

By default, the SIP VP-T49G IP phone supports English and Russia onscreen keyboard. The following takes English keyboard as an example:





No.	Item	Description
1	26 English Letters	Enter letters.
2	Delete Key	Delete the entered characters.
3	Enter Key	<ul style="list-style-type: none"> Confirm the settings. Go to the next field.

No.	Item	Description
4		Switch between the uppercase input mode and the lowercase input mode.
5		Switch between the alphabetical and numeric&symbolic mode.
6		Change the language of the keyboard. You can configure custom keyboard language files to provide other languages. Contact your system administrator for more information.
7	Space Key	Enter spaces.
8	Left and Right Arrow Keys	Position the cursor.
9	Four Special Characters	Enter special characters.
10		Hide the onscreen keyboard.

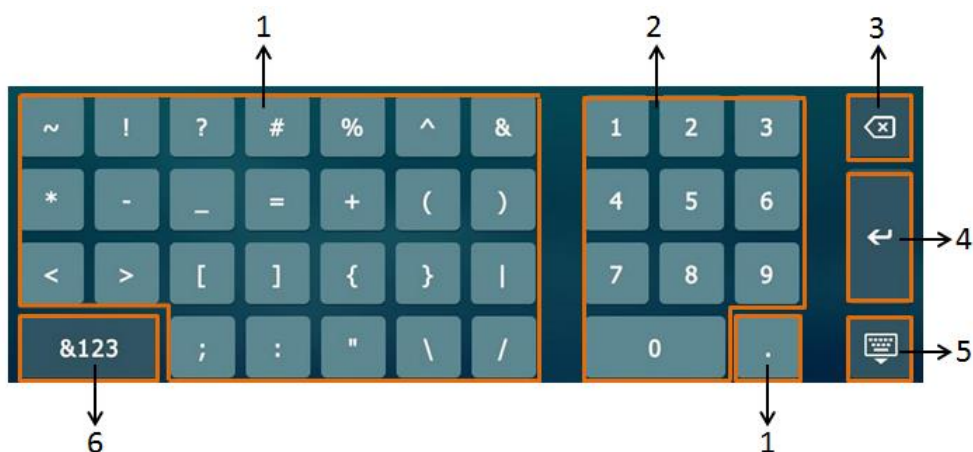



















When you tap  , the onscreen keyboard is shown as below:



No.	Item	Description
1	Special Characters	Enter special characters.
2	Numbers	Enter numbers.
3	Delete Key	Delete the entered characters.
4	Enter Key	<ul style="list-style-type: none"> • Confirm the settings. • Go to the next field.
5		Hide the onscreen keyboard.
6		Switch between the alphabetical and numeric&symbolic mode.

To use onscreen keyboard:

1. Tap the field you want to edit, the onscreen keyboard displays on the touch screen.
2. Enter the information. Do the following:

If you want to	Action
Enter uppercase (A) characters, lowercase (a) characters, or a combination of uppercase and lowercase characters.	<ol style="list-style-type: none"> 1) If a keyboard with characters does not display, tap  or drag  to select  . 2) Tap  or drag  to select  /  to toggle between entering characters in uppercase/lowercase mode. 3) (Optional.) Tap  to switch between English and Russia keyboard. 4) Tap the character(s) you want to enter.
Enter numbers.	<ol style="list-style-type: none"> 1) If a keyboard with numbers does not display, tap  or drag  to select  . 2) Tap the number(s) you want to enter.
Enter special characters.	<ol style="list-style-type: none"> 1) If a keyboard with special characters does not display, tap  or drag  to select  . 2) Tap the special character(s) you want to enter.
Position the cursor.	<ul style="list-style-type: none"> • Tap  or  to position the cursor. • Tap to position.
Confirm the settings/Go to the next field.	<ul style="list-style-type: none"> • If there is only one field or the field you are editing is the last one of the configuration, tap  to confirm the setting. • If the field you are editing is not the last one of the configuration, tap  to go to the next field.
Delete characters one by one.	<ol style="list-style-type: none"> 1) Position the cursor to the right side of the text you want to delete. 2) Tap  .
Delete more characters at a time.	<ol style="list-style-type: none"> 1) Drag your finger to highlight the characters you want to delete. 2) Tap  .
Replace characters.	<ol style="list-style-type: none"> 1) Drag your finger to highlight the characters you want to delete. 2) Tap the character(s) you want.

For letters, special characters and number keys, you can drag the icon to select other available characters.

The original onscreen keyboard key only provide one character, you can configure a custom keyboard lme file to make the key provide more characters. Contact your administrator for more information.



The character cannot be entered until you release your finger from the key.

3. Tap  to hide the onscreen keyboard.
4. (Optional.) Tap the **Save** soft key to accept the change.

Using the Phone Keypad and Dial Pad

Instead of using the onscreen keyboard, you can also use the keypad on your phone or dial pad on the dialing screen to enter data. And only numbers or * or # can be entered by using the keypad and dial pad.















The following displays the dial pad on dialing screen:



To use phone keypad:

1. Pick up the handset, press the Speakerphone key or tap the line key.
2. Do one of the following:

If you want to	Action
Enter only digits (1),	Press a keypad key one or more times

If you want to	Action
uppercase (A) characters, lowercase (a) characters, or alphanumeric (2aB) characters.	<p>(depending what input mode you're in) to enter the characters that is displayed on the keypad key.</p> <p>You can tap  one or more times to switch among uppercase (ABC), numeric (123), alphanumeric (2aB) and lowercase (abc) input modes.</p> <p>For example, if the input mode is ABC:</p> <ul style="list-style-type: none"> - To enter "A", press  once. - To enter "B", press  twice quickly. - To enter "C", press  three times quickly.
Enter special characters.	<ul style="list-style-type: none"> • Press the keypad key ,  or . <ul style="list-style-type: none"> For  key: <ul style="list-style-type: none"> - If it is the uppercase (ABC) or lowercase (abc) input mode, it will provide the space character. - If it is the numeric (123) or alphanumeric (2aB) input mode, it will only provide the digit 0. For  key: <ul style="list-style-type: none"> - It only provides the pound character #. For  key: <ul style="list-style-type: none"> - If it is the uppercase (ABC), lowercase (abc) or alphanumeric (2aB) input mode, it will provide the following special characters: ./@+-\$[]. - If it is the numeric (123) input mode, it will only provide the following special characters: *.:@. • Tap  one or more times to set the input mode to . It will provide the following special characters: ./@\$;' +;[]-*_#&. Tap the character(s) you want to enter.
Delete characters one by one.	<ol style="list-style-type: none"> 1) Position the cursor to the right side of the text you want to delete. 2) Tap .
Delete more characters at a time.	<ol style="list-style-type: none"> 1) Drag your finger to the left or right to highlight the characters you want to delete. 2) Tap .
Replace characters.	<ol style="list-style-type: none"> 1) Drag your finger to highlight the characters

If you want to	Action
	you want to delete. 2) Tap the character(s) you want to enter.

Phone Status

You can view phone status via phone user interface or web user interface.

Available information of phone status includes:

- General information (IP address, MAC address and firmware version)
- Network status (e.g., IPv4 status, IPv6 status, IP address mode and MAC address)
 - IPv4 uses a 32-bit address.
 - IPv6 is an updated version of the current Internet Protocol to meet the increased demands for unique IP addresses, using a 128-bit address.
- Phone status (e.g., product name, hardware version, firmware version, product ID, MAC address and device certificate status)
- Account status (e.g., register status of SIP accounts)

Note You can view the device certificate status via phone user interface only.

To view the phone status via phone user interface:

1. Tap  -> **Status**.

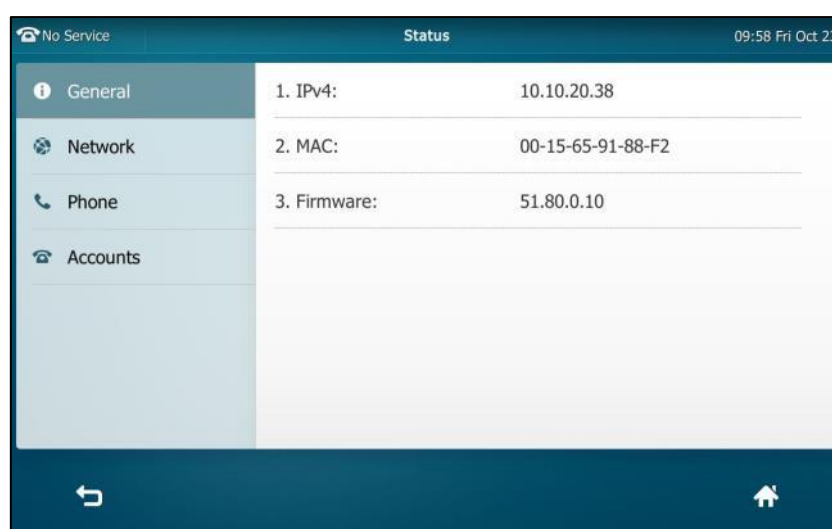

2. Tap the desired item to view the specific information.

To view the phone status via web user interface:

1. Open a web browser on your computer.
2. Enter the IP address in the browser's address bar, and then press the **Enter** key.

(e.g., “http://192.168.0.10” for IPv4 or “http://[2005:1:1:1:215:65ff:fe64:6e0a]” for IPv6).

3. Enter the user name (admin) and password (admin) in the login page.

4. Click **Confirm** to login.

The phone status is displayed on the first page of the web user interface.

Category	Item	Value
Version	Firmware Version	51.80.0.10
	Hardware Version	51.0.0.0.0.0.0
Network	Internet Port	IPv4
IPv4	WAN Port Type	DHCP
	WAN IP Address	10.10.20.38
	Subnet Mask	255.255.255.0
	Gateway	10.10.20.254
	Primary DNS	192.168.1.20
	Secondary DNS	192.168.1.22
	Network Common	MAC Address
Link Status		Connected
Device Type		Bridge
Account Status	Account1	Disabled
	Account2	Disabled
	Account3	Disabled

NOTE
Version
 It shows the version of firmware.
Network
 It shows the information of WAN port.
 You can click here to get more guides.

Note

If IP mode of the phone is configured as **IPv4 & IPv6**, you can enter either of them in the browser’s address bar to view the phone status. IPv6 is not available on all servers. Contact your system administrator for more information.

Basic Network Settings

If your phone cannot contact a DHCP server for any reason, you need to configure

network settings manually. The IP phone can support either or both IPv4 and IPv6 addresses.

To configure the IP mode via phone user interface:

1. Tap  -> **Advanced** (default password: admin) -> **Network**->**WAN Port**.
2. Tap the **IP Mode** field.
3. Tap the desired value (**IPv4**, **IPv6** or **IPv4 & IPv6**) in the pop-up dialog box.

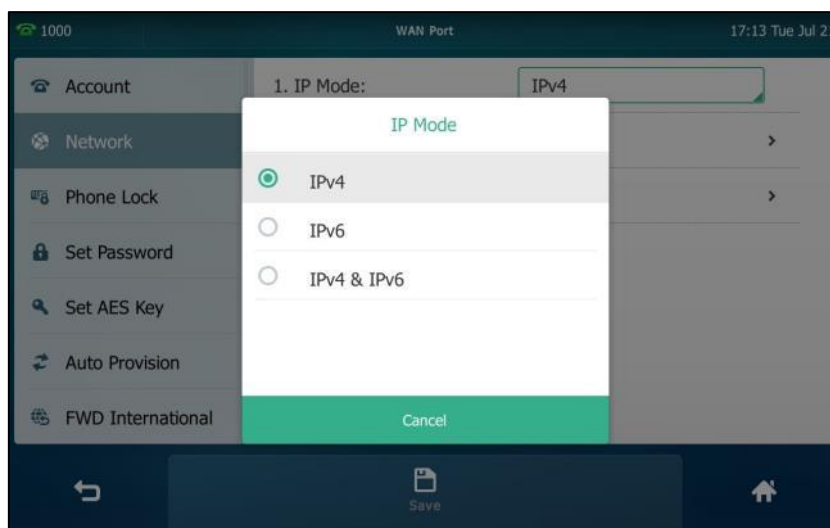

4. Tap the **Save** soft key to accept the change or  to cancel.

You can configure a static IPv4 address for the IP phone. Before configuring it, make sure that the IP mode is configured as **IPv4** or **IPv4 & IPv6**.

To configure a static IPv4 address via phone user interface:

1. Tap  -> **Advanced** (default password: admin) -> **Network**->**WAN Port**->**IPv4**.
2. Tap the **Type** field.
3. Tap **Static IP** in the pop-up dialog box.

4. Enter the desired value in the **IP, Subnet Mask, Gateway, Primary DNS** and **Secondary DNS** field respectively.

Field	Value
1. Type:	Static IP
2. IP:	192.168.1.20
3. Subnet Mask:	255.255.255.0
4. Gateway:	192.168.1.254
5. Primary DNS:	202.101.103.55
6. Secondary DNS:	202.101.103.56

5. Tap the **Save** soft key to accept the change or to cancel.
You can configure a static IPv6 address for the IP phone. Before configuring it, make sure that the IP mode is configured as **IPv6** or **IPv4 & IPv6**.

To configure a static IPv6 address via phone user interface:

1. Tap -> **Advanced** (default password: admin) -> **Network**->**WAN Port**->**IPv6**.
2. Tap the **Type** field.
3. Tap **Static IP** in the pop-up dialog box.
4. Enter the desired value in the **IP, IPv6 IP Prefix, Gateway, Primary DNS** and **Secondary DNS** field respectively.

Field	Value
1. Type:	Static IP
2. IP:	2005:1:1:1::12
3. IPv6 IP Prefix:	64
4. Gateway:	2005:1:1:1::1
5. Primary DNS:	2005:1:1:1::88
6. Secondary DNS:	2005:1:1:1::89

5. Tap the **Save** soft key to accept the change or to cancel.

If you are using an xDSL modem for IPv4 network connection, you can connect your phone to the Internet via PPPoE mode. Set the WAN port as a PPPoE port. The PPPoE port

will perform a PPP negotiation to obtain the IP address. Contact your system administrator for the PPPoE user name and password.

To configure PPPoE via phone user interface:

1. Tap  -> **Advanced** (default password: admin) -> **Network**->**WAN Port**->**IPv4**.
2. Tap the **Type** field.
3. Tap **PPPoE** in the pop-up dialog box.
4. Enter the PPPoE user name and password in the corresponding fields.

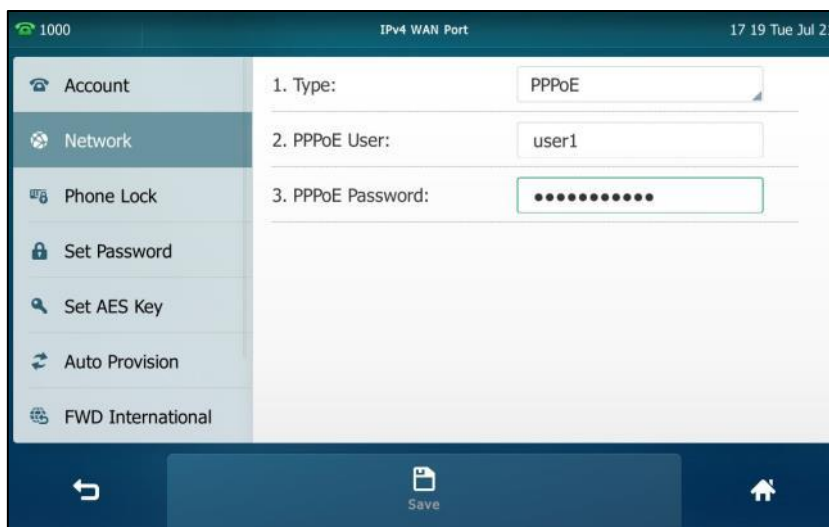

5. Tap the **Save** soft key to accept the change or  to cancel.

Note

The wrong network settings may result in inaccessibility of your phone and may also have an impact on your network performance. For more information on these parameters, contact your system administrator.

Wireless Network Settings

Yealink SIP VPT49G IP phone supports Wi-Fi feature. You can connect your phone to a 2.4G/5G wireless network, and configure the country wireless channel for the IP phone. For more information, contact your system administrator.

Connecting to the Wireless Network

Three ways to connect SIP VPT49G IP phone to the wireless network:

- Manually connect to an available wireless network
- Wi-Fi Protected Setup (WPS)
- Manually add a wireless network

When the phone is connected to a wireless network, the Wi-Fi icon  will display on

the status bar of the touch screen. The Wi-Fi icon indicates the signal strength. The more green arcs you see, the stronger the signal strength is. For more information, refer to [Icon Instructions](#) on page 15.

Manually Connect to an Available Wireless Network

You can manually connect your phone to a wireless network.

To manually connect to an available wireless network via phone user interface:

1. Tap  -> **Basic**->**Wi-Fi**.
2. Tap the **On** radio box in the **Wi-Fi** field.

The phone will automatically search for available wireless networks in your area.

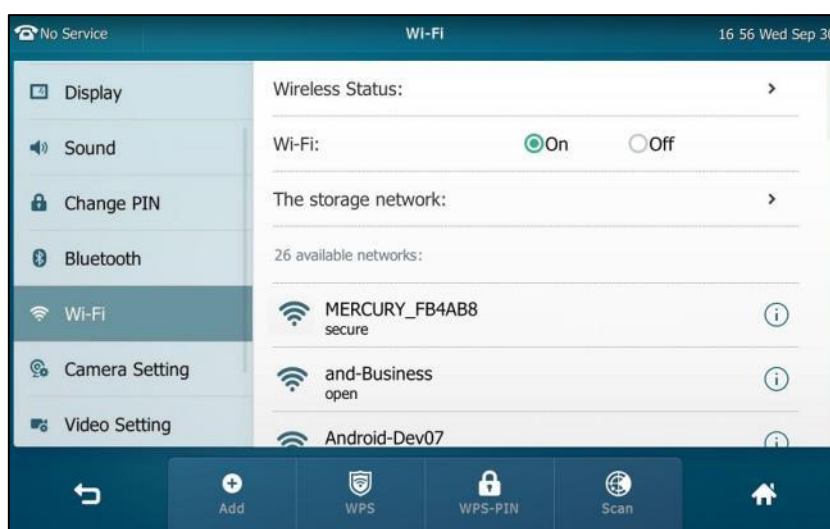

3. (Optional.) To re-search the available network, tap the **Scan** soft key.
4. Tap the desired wireless network (SSID) to connect to it.
You can also tap  after the desired SSID, and then tap **Connect**.
5. If the network is secure, enter its password in the **PIN** field.

Contact your network administrator for the Wi-Fi password.

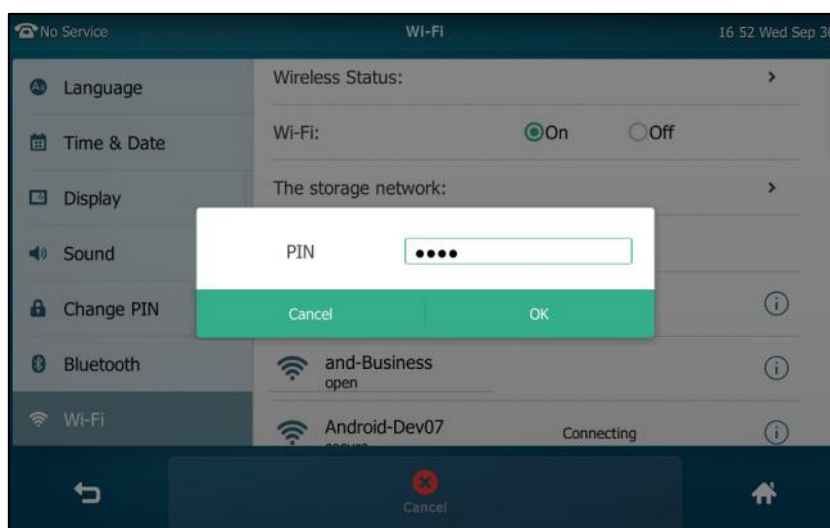

6. Tap **OK** to connect to the wireless network.

Once the connection has completed successfully, the prompt “Connect Success.” appears after the desired SSID.

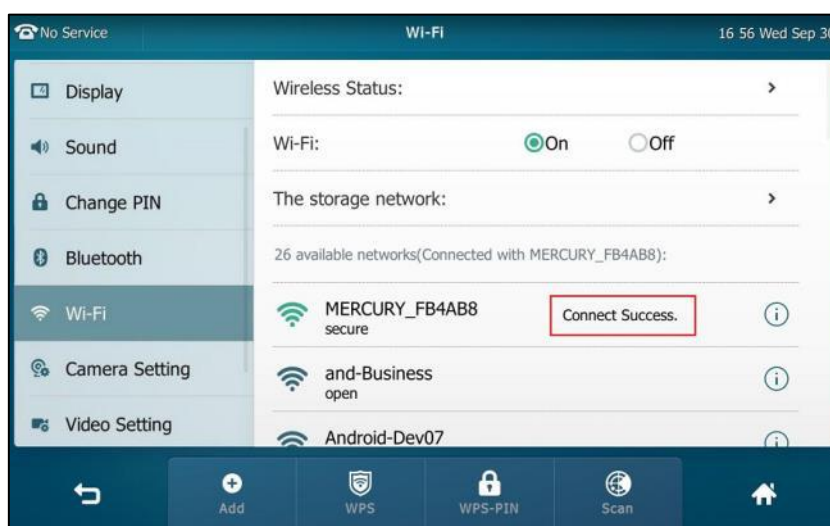

The connected wireless network will be saved in the storage network list. You can tap **The storage network** to view all the storage wireless networks.

You can also swipe down from the top of the screen to enter the control center, and toggle **Wi-Fi** on. The phone will automatically search for wireless network in your area and try to connect the wireless network with highest priority which is saved in the storage network list. If there are no available wireless networks or the phone cannot connect the wireless network saved in the storage network list, the touch screen will prompt “No available Wi-Fi, go to Wi-Fi setting now”. Tap **OK**. Repeat steps 4 to 6 to connect to the desired wireless network.

You can also manually connect your phone to an available wireless network via web user interface at the path **Network->Wi-Fi**.

Wi-Fi Protected Setup (WPS)

Wi-Fi Protected Setup (WPS) provides simplified mechanisms to configure secure wireless networks. WPS can automatically configure a wireless network with a network name (SSID) and strong WPA data encryption and authentication.

Two methods supported by Yealink IP phones in the Wi-Fi protected setup:

- Push Button Configuration (PBC): The user simply has to push the WPS key on both the IP phone and gateway/router to connect.
- Personal Identification Number (PIN): The user has to enter a WPS PIN generated randomly by the IP phone on the gateway/router to connect.

Push Button Configuration (PBC)

To connect to the wireless network using PBC method:

1. Tap  -> **Basic**->**Wi-Fi**.
2. Tap the **On** radio box in the **Wi-Fi** field.

The phone will automatically search for available wireless networks in your area.

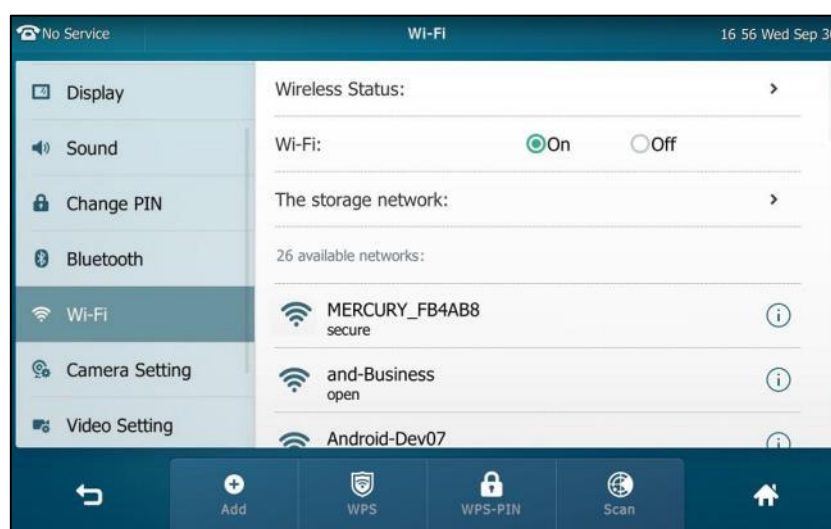

3. Tap the **WPS** soft key.
The touch screen prompts "WPS has opened, please connect in 120s".
4. Long press the WPS key on your gateway/router.
Once WPS setup has completed successfully, the touch screen will prompt "Connect Success."

Personal Identification Number (PIN)

To connect to the wireless network using PIN method:

1. Tap  -> **Basic**->**Wi-Fi**.
2. Tap the **On** radio box in the **Wi-Fi** field.

The phone will automatically search for available wireless networks in your area.

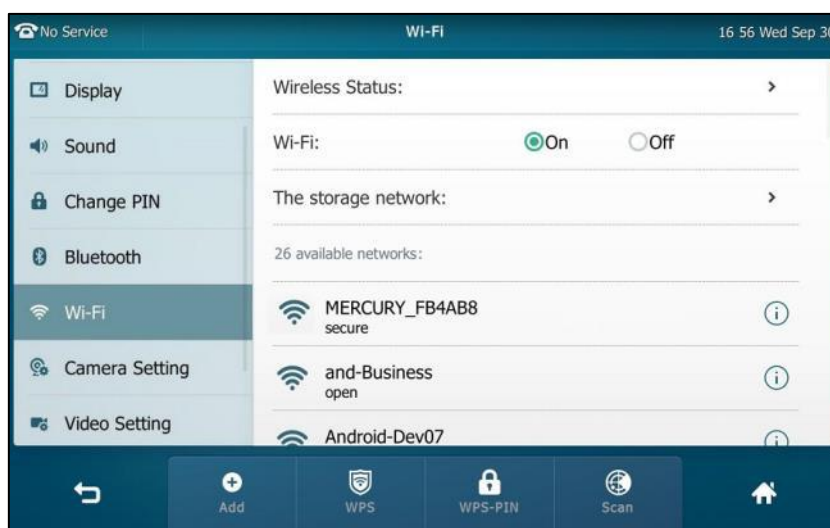

3. Tap the **WPS-PIN** soft key.

The touch screen pops up a prompt containing a randomly generated PIN.

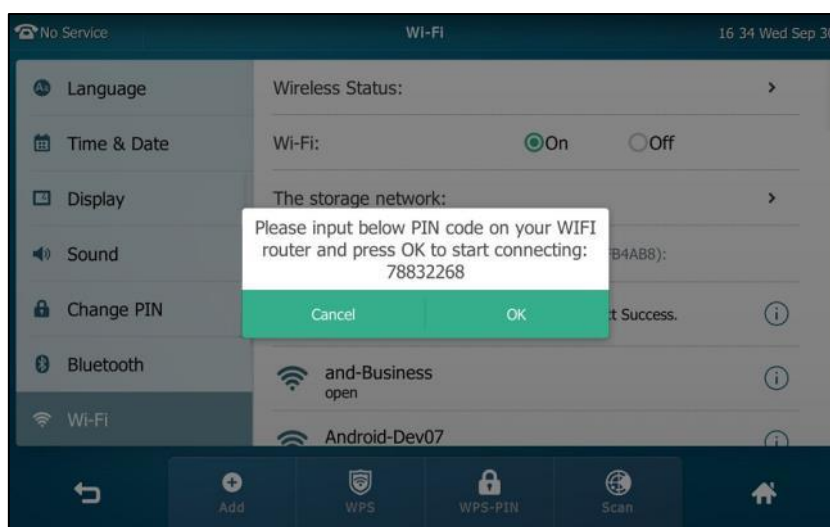

4. Note the PIN code, and then tap **OK**.

The touch screen prompts “WPS has opened, please connect in 120s”.

5. Enter the gateway/router address in the address bar of a web browser on your PC connected to the gateway/router.
6. Enter the user name and password in the login page.
7. Locate the **WPS Wizard** configuration menu.
8. Enter the PIN code in the field that allows you to setup wireless devices by using a PIN.
9. Click the corresponding button in the gateway/router’s web interface to search WPS clients.

Once WPS setup has completed successfully, the touch screen will prompt "Connect Success."

Note Contact your gateway/router provider for more information.

Manually Add a Wireless Network

If your gateway/router has SSID broadcast disabled, it might not appear in the scanning results. In that case, you must manually add a wireless network.

To add a wireless network:

1. Tap  -> **Basic**->**Wi-Fi**.
2. Tap the **On** radio box in the **Wi-Fi** field.
3. Tap the **Add** soft key.





4. Tap the **Security Mode** field.
5. Tap the desired value in the pop-up dialog box.
 - If you select **None** or **WEP**:
 - 1) Enter the desired profile name in the **Profile Name** field.
 - 2) Enter the desired value in the **SSID** field.
 - 3) Enter the desired password in the **WPA Shared Key** field.
 - If you select **WPA PSK** or **WPA2 PSK**:
 - 1) Enter the desired profile name in the **Profile Name** field.
 - 2) Enter the desired value in the **SSID** field.
 - 3) Tap the **Cipher Type** field.
 - 4) Tap the desired Cipher type (**TKIP**, **AES** or **TKIP+AES**) in the pop-up dialog box.
 - 5) Enter the desired password in the **WPA Shared Key** field.

6. Tap the **Save** soft key to accept the change.

Disconnecting the Wireless Network Connection

You can disconnect the wireless network connection from your phone. After you disconnect the wireless network connection, it will still be displayed in **The storage network** list. So you can easily connect your phone to it again.

To disconnect the wireless network:

1. Tap  -> **Basic**->**Wi-Fi**.
2. Do one of the following:
 - Tap the connected SSID (the top one) in the **available networks** list.
 - Tap  after the connected SSID (the top one).
Tap **Disconnect**.



- Tap **The storage network**.

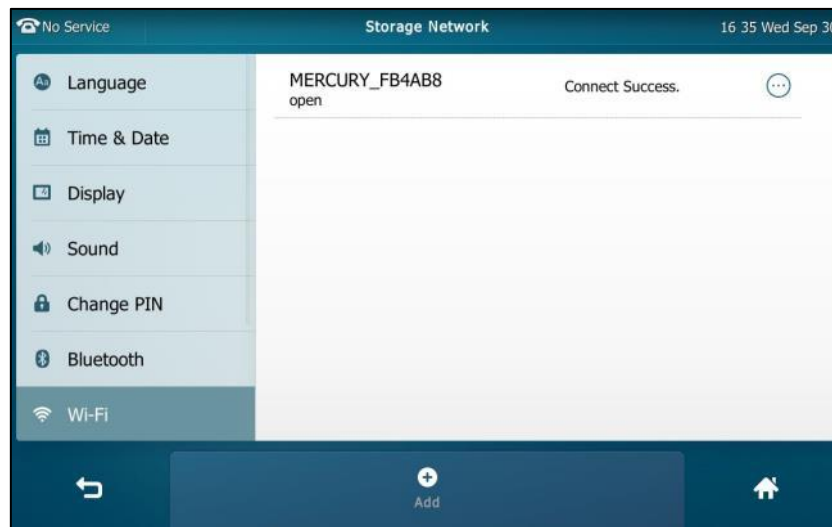

Tap the connected SSID.



The touch screen will prompt: **Disconnect success.**

Viewing the Wireless Network Information

To view the wireless network information:

1. Tap  -> **Basic**->**Wi-Fi**.
2. Tap  after the desired SSID to view the detailed wireless network information (e.g., Profile Name, SSID or Signal Strength).

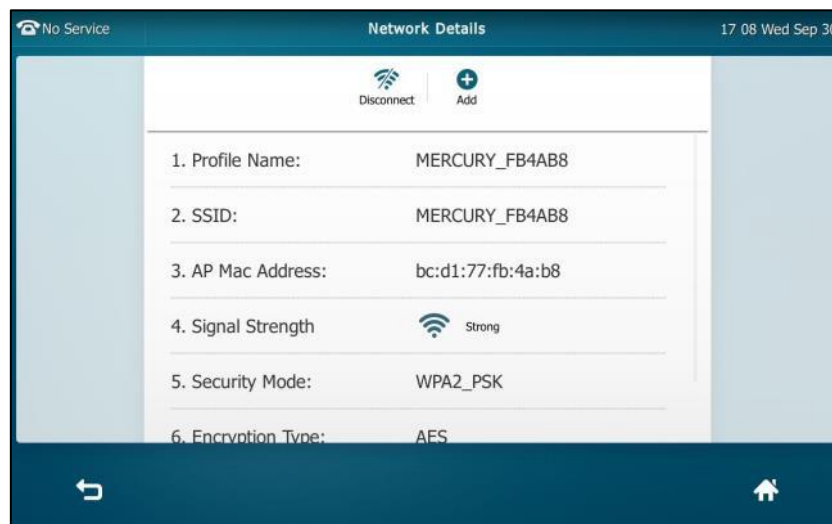

If the IP phone is being connected to a wireless network successfully, you can also tap **Wireless Status** to view the connected wireless network information.

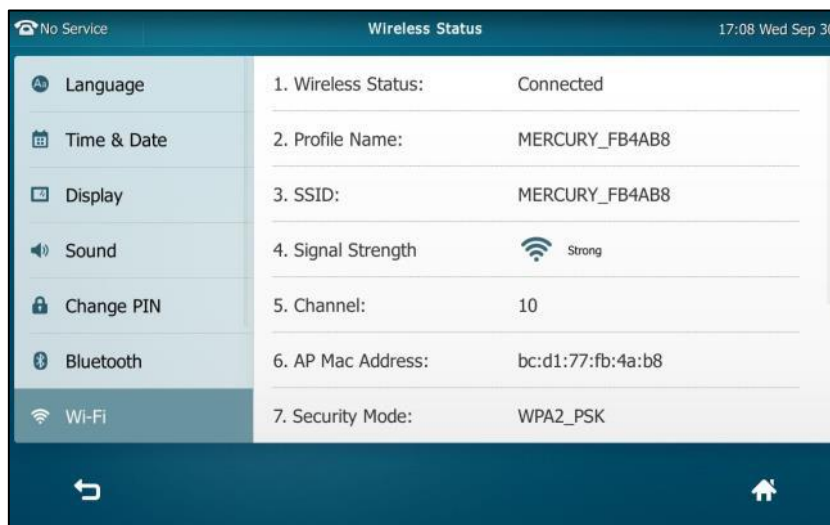

Managing the Saved Wireless Network

Once the IP phone has ever connected to wireless network successfully, the wireless network profile will be saved in **The storage network** list. The next time you enable Wi-Fi feature, the IP phone will be automatically connected to the wireless network which has the highest priority (the top one). Up to 5 wireless network profiles can be saved in **The storage network** list. If you want to add a new one when the IP phone has already saved 5 wireless network profiles, please delete the older saved profile before adding.

To manage the saved wireless network:

1. Tap -> **Basic**-> **Wi-Fi**.
2. Tap **The storage network** to view the saved wireless networks.

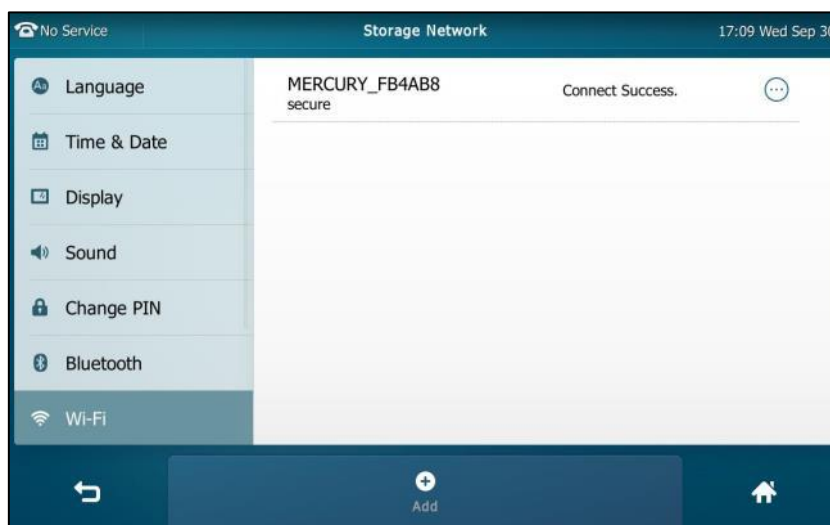

3. Tap .

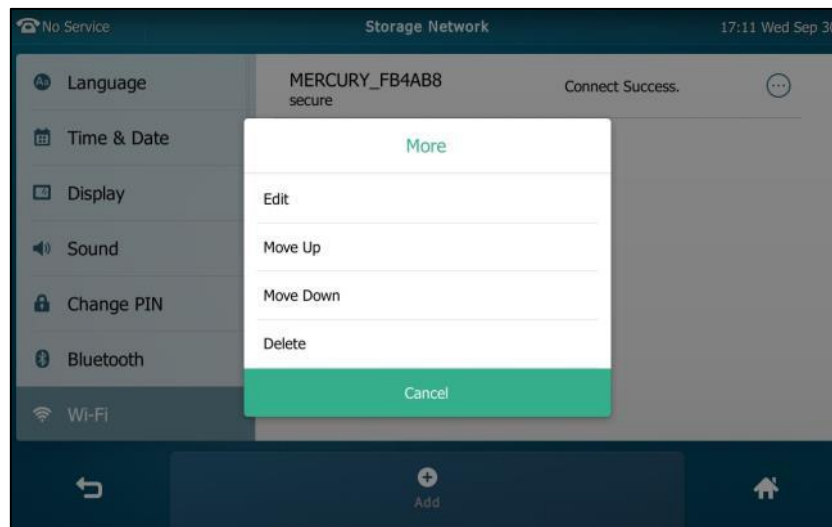

4. Do the following:
- To edit the wireless network profile:
 - 1) Tap **Edit**.
 - 2) Edit the desired wireless network information.
 - 3) Tap the **Save** soft key.
 - To change the priority of the wireless network:
 - 1) Tap **Move Up** or **Move Down** to improve or lower the priority of the wireless network that the IP phone automatically connects to.
 - To delete the saved wireless network profile:
 - 1) Tap **Delete**.

If you delete your wireless network profile from your phone, you need to manually connect to it next time.

Disabling Wi-Fi Feature

To disable Wi-Fi feature, do one of the following:

- Tap  -> **Basic**-> **Wi-Fi**.

Tap the **Off** radio box in the **Wi-Fi** field.



- Swipe down from the top of the screen to enter the control center, and toggle **Wi-Fi** off.

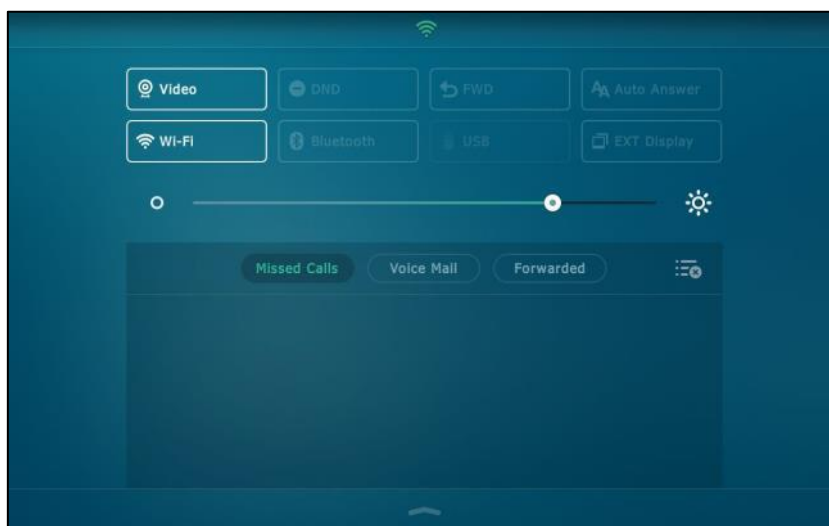

The icon  disappears from the touch screen.

Wi-Fi feature is configurable via web user interface at the path **Network->Wi-Fi**.

Customizing Your Phone

You can customize your SIP VP-T49G IP phone by personally configuring certain settings, for example, wallpaper, time & date and ring tones. You can add contacts to the phone's local directory manually or from call history. You can also personalize different ring tones for different callers.

This chapter provides basic operating instructions for customizing your phone. Topics include:

- [General Settings](#)
- [Audio Settings](#)
- [Contact Management](#)
- [Call History Management](#)
- [System Customizations](#)

If you require additional information or assistance with your new phone, contact your system administrator.

General Settings

Wallpaper



You can customize the wallpaper of the SIP VP-T49G IP phone, and can change the wallpaper image via phone user interface or web user interface. You can also upload custom wallpaper images via web user interface or using a USB flash drive.

The SIP VP-T49G IP phone supports the file format of wallpaper image in the following table:

Format	Resolution	Wallpaper Size
.jpg/.png/*.bmp	1280*800	≤5MB

Changing the Wallpaper via Phone User Interface

To change the wallpaper via phone user interface:

1. Tap  -> **Basic**->**Display**->**Wallpaper**.
2. To select the desired wallpaper, you can:
 - Tap  or .

- Tap the **Wallpaper** field, and then select the desired wallpaper.

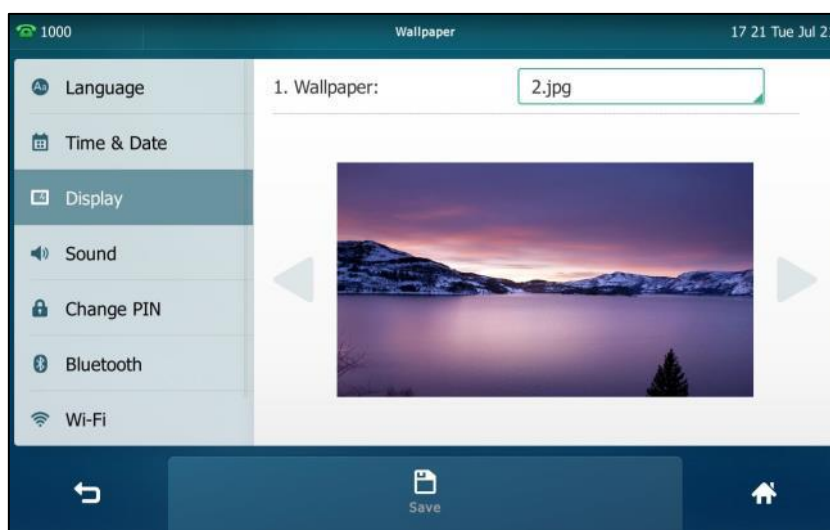

3. Tap the **Save** soft key to accept the change or  to cancel.

Wallpaper is configurable via web user interface at the path **Settings->Preference**.

Uploading the Custom Wallpaper via Web User Interface

To upload the custom wallpaper via web user interface:

1. Click on **Settings->Preference**.
2. In the **Upload Wallpaper** field, click **Upload File** to locate and upload the wallpaper image from your local system.

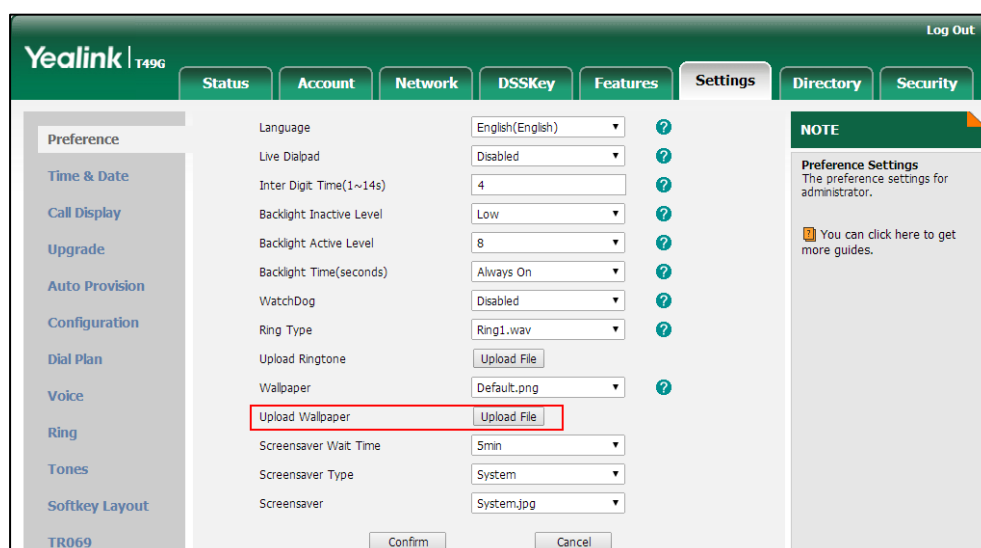

The web user interface prompts “Upload success!”. The custom wallpaper appears in **Wallpaper** list. You can only delete the custom wallpaper by clicking **Del** in the **Wallpaper** field.

Setting Wallpaper by Using USB Flash Drive

You can set a picture stored in your USB flash drive as the wallpaper. Before setting the picture in your USB flash drive as the wallpaper, ensure that the picture is in the USB flash drive, and the USB flash drive is connected to your phone. For more information on how to connect the USB flash drive, refer to [Connect the optional USB flash drive](#) on page 31.

To set a picture in the USB flash drive as the wallpaper:

1. Tap  ->USB->**Browse Photo**.
2. Tap the desired picture to preview.
3. Tap **Set Wallpaper** on the bottom of the screen.

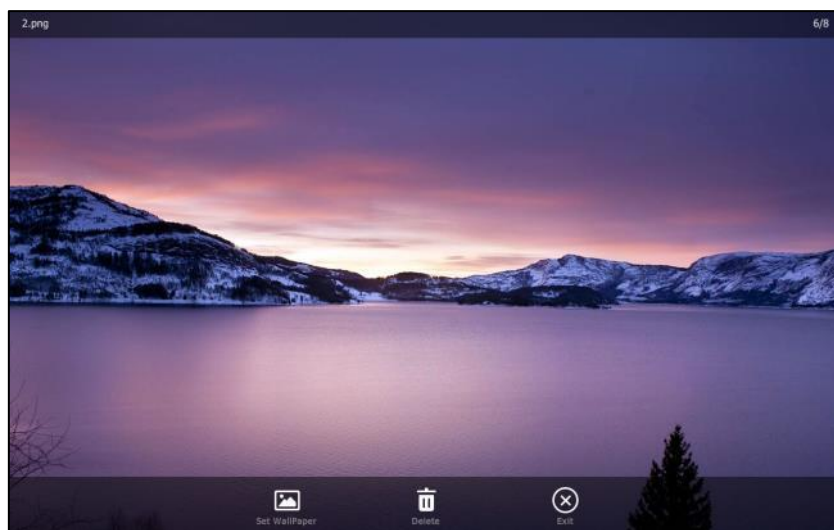

The touch screen prompts “Set current picture as wallpaper?”.

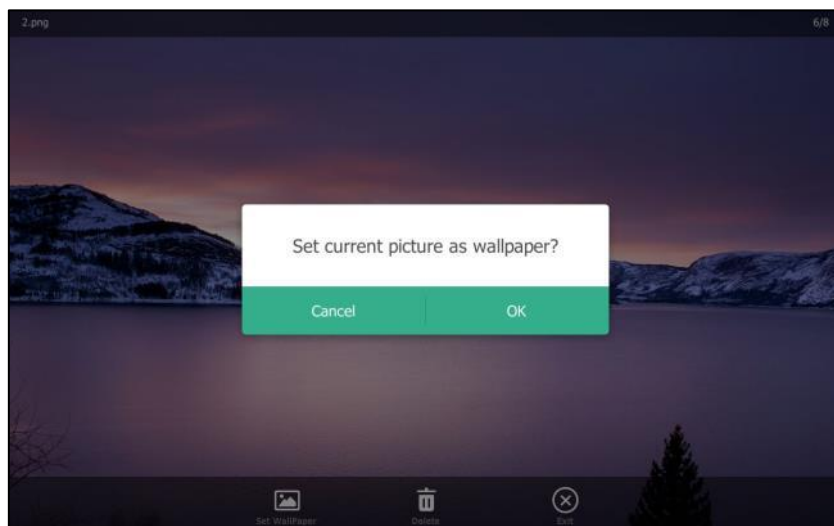

4. Tap **OK** to accept the change or **Cancel** to cancel.

Wallpaper displayed on the phone user interface will change to the selected one and the custom wallpaper appears in **Wallpaper** list at the path  ->**Basic**->**Display**->**Wallpaper**.

Note

The SIP VP-T49G IP phone screen size is 1280*800 pixels. If the size of the custom wallpaper doesn't meet the IP phone screen size, the wallpaper will be stretched or/and zoomed out according to the IP phone screen size.

Screen Saver

The screen saver will automatically start each time your phone is idle for a certain amount of time. The screen saver is used to blank the screen or fill it with moving images or patterns. You can stop the screen saver at any time and return to the idle screen by tapping the touch screen or pressing a key on the phone. If your phone is idle again for a specified period of time, the screen saver will start again.

You can configure the screen saver of SIP VP-T49G IP phone, and upload custom pictures to set up a screen saver of your picture via web user interface. You can only configure the screen saver wait time via phone user interface.

The SIP VP-T49G IP phone supports the file format of custom pictures in the following table:

Format	Resolution	Picture Size
.jpg/.png/*.bmp	1280*800	≤5MB

Uploading the Custom Picture via Web User Interface

To upload a custom picture via web user interface:

1. Click on **Settings**->**Preference**.
2. Select **Upload Picture** from the pull-down list of **Screensaver Type**.
3. In the **Upload Screensaver** field, click **Upload File** to locate and upload the custom picture from your local system.

This field appears only if **Screensaver Type** is set to **Upload Picture**.

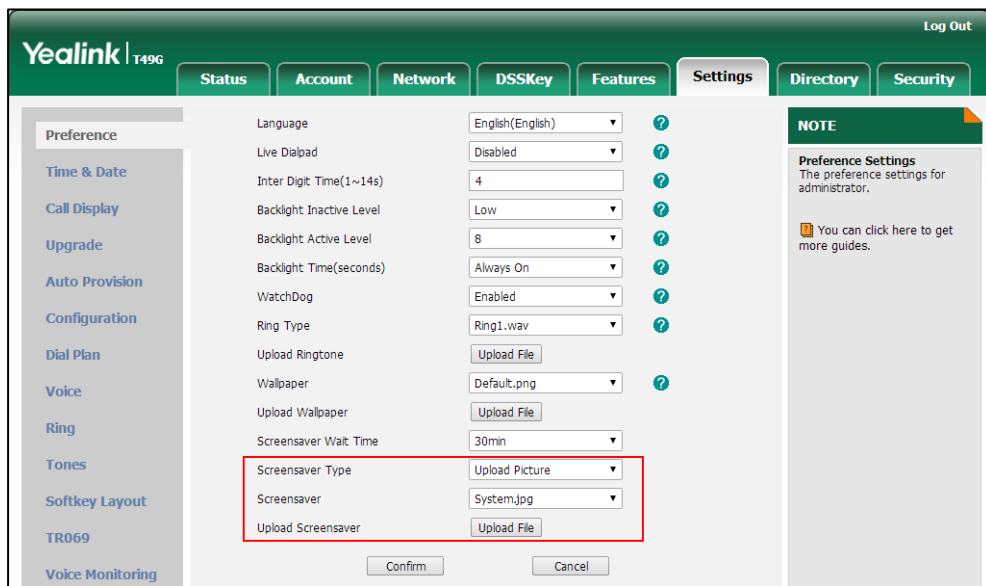

The web user interface prompts “Upload success!”. The custom picture appears in **Screensaver** list. The first picture in the list is System.jpg. You can only delete the custom picture by clicking **Del** in the **Screensaver** field.

Note You can only upload one custom image at a time via web user interface.

Configuring the Screen Saver

To configure the screen saver wait time via phone user interface:

1. Tap  -> **Basic**->**Display**->**Screensaver**.
2. Tap the **Wait Time(s)** field.
3. Tap the desired value in the pop-up dialog box.

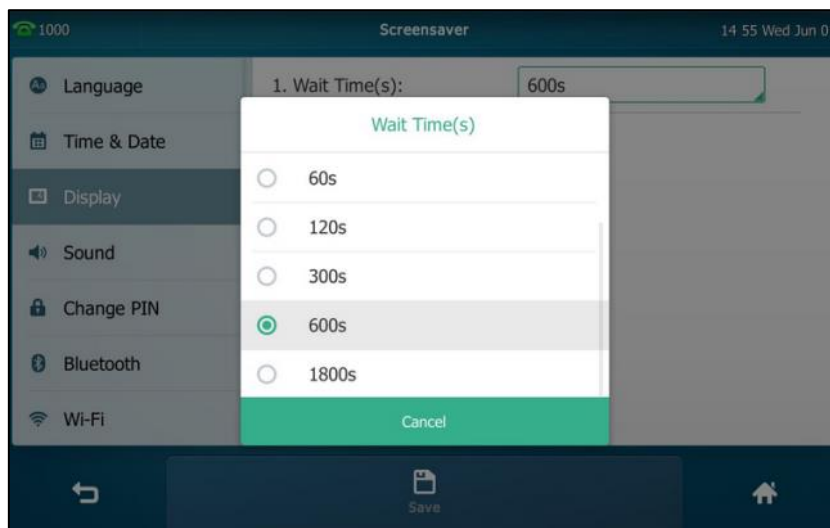

4. Tap the **Save** soft key to accept the change or  to cancel.

To configure the screen saver via web user interface:

1. Click on **Settings->Preference**.
2. Select the desired wait time from the pull-down list of **Screensaver Wait Time**.
You can set to 15s, 30s, 1min, 2min, 5min, 10min or 30min. The default value is 30min. After no activity, the phone will wait the specified period of time before displaying the screen saver.
3. Select the desired screen saver type from the pull-down list of **Screensaver Type**.
 - If you select **System**.
The IP phone will automatically set System.jpg as the screen saver.

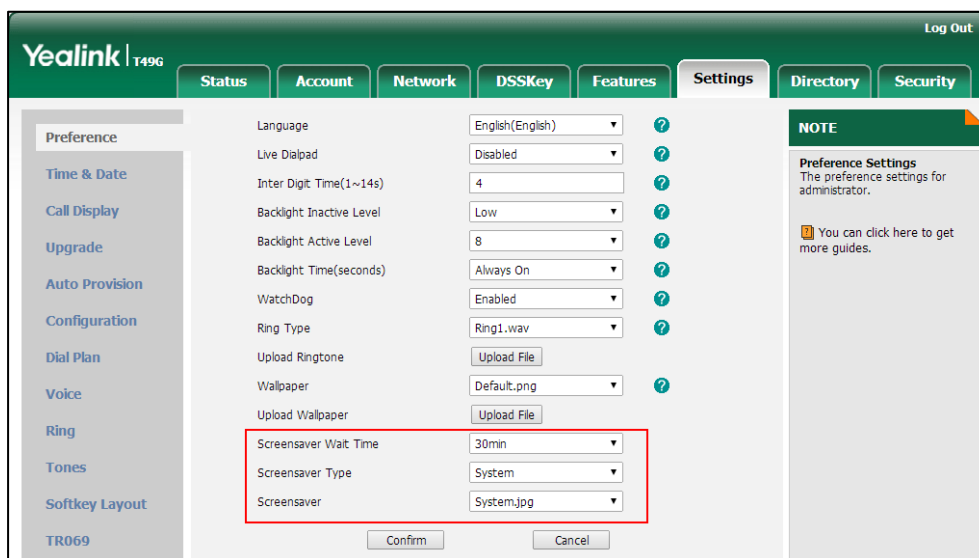

- If you select **Upload Picture**.
The IP phone will automatically set the custom pictures you upload as the screen saver, and display these pictures alternately.
4. Click **Confirm** to accept the change.

Power Saving

The power saving feature is used to turn off the screen to conserve energy. The IP phone enters power-saving mode after it has been idle for a certain period of time. And the IP phone will exit power-saving mode if a phone event occurs—for example, if the phone has an incoming call or message, or you press a key on the phone or tap the touch screen. If the screen saver is enabled on your phone, power-saving mode will still occur.

You can configure the following power-saving settings:

- Office Hour
- Idle Timeout (minutes)

Note Power saving is configurable via web user interface only.

Configuring the Office Hour via Web User Interface

Office Hour specifies the starting time and ending time in the office each day.

To configure the office hour via web user interface:

1. Click on **Settings->Power Saving**.
2. Select a desired day of the week.
3. Enter the starting time and ending time respectively in the desired day field.

Day	Start Time	End Time	Help
Monday	07	19	?
Tuesday	07	19	?
Wednesday	07	19	?
Thursday	07	19	?
Friday	07	19	?
Saturday	07	07	?
Sunday	07	07	?

Idle TimeOut (minutes)

Office Hour Idle TimeOut: ?

Off Hour Idle TimeOut: ?

User input extention Idle TimeOut: ?

NOTE
settings-powersaving-note
You can click here to get more guides.

4. Click **Confirm** to accept the change.

Configuring the Idle Timeout via Web User Interface

Idle Timeout specifies the period of time before the IP phone enters power-saving mode. The following three types of idle timeout you can configure:

- **Office Hours Idle Timeout:** Configures the idle timeout for office hours.
- **Off Hours Idle Timeout:** Configures the idle timeout for non-office hours.
- **User input extension Idle Timeout:** Configures idle timeout that applies after you

use the IP phone (for example, press a key on the phone, pick up/hang up the handset or tap the touch screen).

By default, the Office Hours Idle Timeout is much longer than the Off Hours Idle Timeout. If you use the IP phone, the idle timeout that applies (User input extension Idle Timeout or Office Hours/Off Hours Idle Timeout) is the timeout with the highest value. If the phone has an incoming call or message, the User input extension Idle Timeout is ignored.

To configure the idle timeout via web user interface:

1. Click on **Settings->Power Saving**.
2. Enter the desired value in the **Office Hours Idle Timeout** field.
The default value is 120, you can set to 1-240.
3. Enter the desired value in the **Off Hours Idle Timeout** field.
The default value is 10, you can set to 1-10.
4. Enter the desired value in the **User input extension Idle Timeout** field.
The default value is 10, you can set to 1-20.

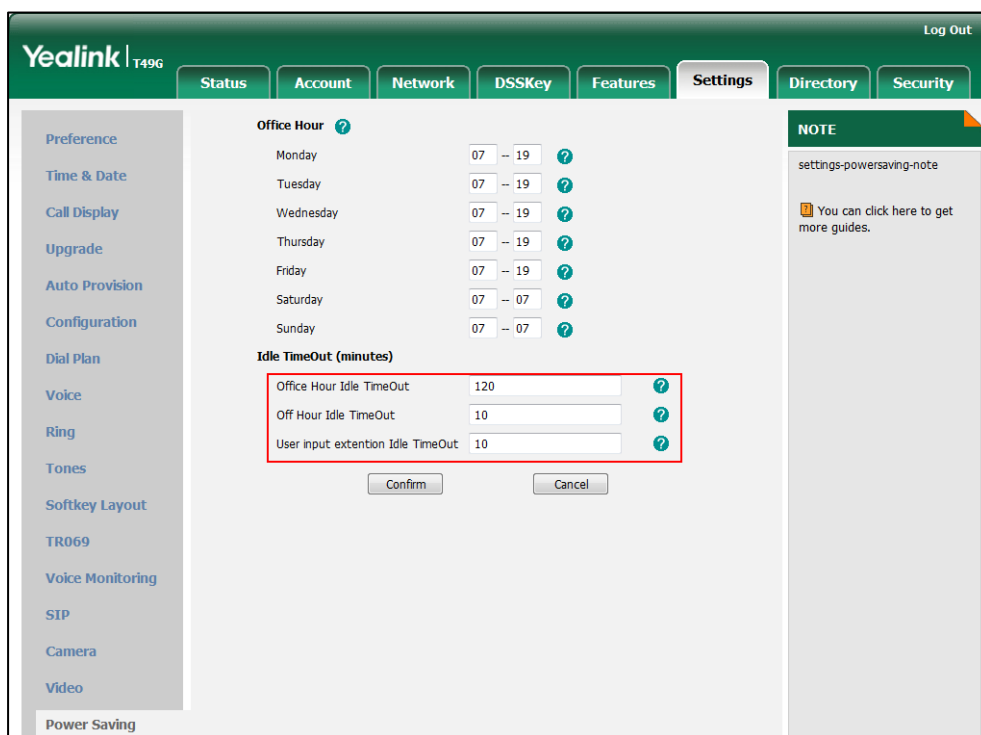

5. Click **Confirm** to accept the change.

Backlight

Backlight has three options:

Backlight Active Level: The intensity of the touch screen when the phone is active. You can change the intensity of the touch screen by dragging the backlight active level slider.

Backlight Inactive Level: The intensity of the touch screen when the phone is inactive. You can select a low intensity or turn off the backlight.

Backlight Time: The delay time to change the intensity of the touch screen when the phone is inactive. You can select a desired time to change the intensity or turn on the backlight permanently.

- **Always On:** Backlight is on permanently.
- **15s, 30s, 60s, 120s, 300s, 600s or 1800s:** Backlight is changed when the phone is inactive after the designated time (in seconds).

To configure the backlight via phone user interface:

1. Tap  -> **Basic**->**Display**->**Backlight**.
2. Drag the **Backlight Active Level** slider.
3. Tap the **Backlight Inactive Level** field.
4. Tap the desired value in the pop-up dialog box.
5. Tap the **Backlight Time** field.
6. Tap the desired time in the pop-up dialog box.

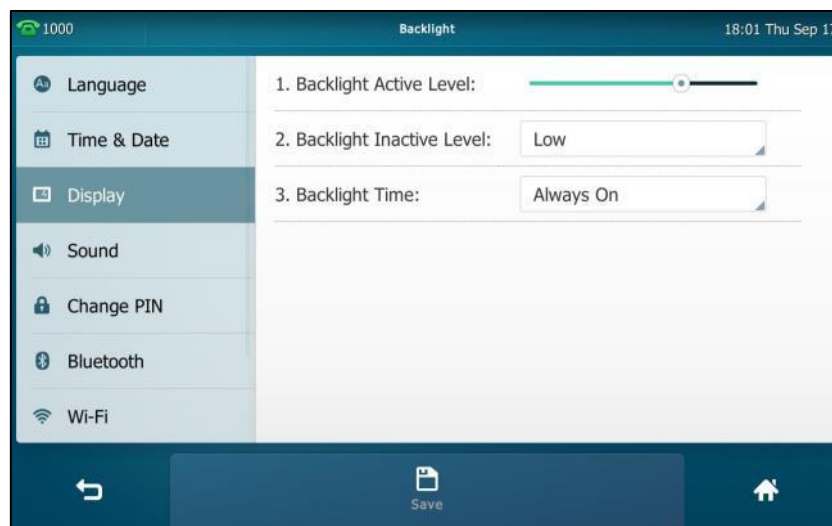

7. Tap the **Save** soft key to accept the change or  to cancel.

Backlight is configurable via web user interface at the path **Settings->Preference**.

Language

The default language of the phone user interface is English. If the language of your web browser is not supported by the phone, the web user interface will use English by default. You can change the language for the phone user interface and the web user interface respectively.

To change the language for the phone user interface:

1. Tap  ->**Basic**->**Language**.
2. Drag up and down to scroll through the list of available languages.
3. Tap the desired language.

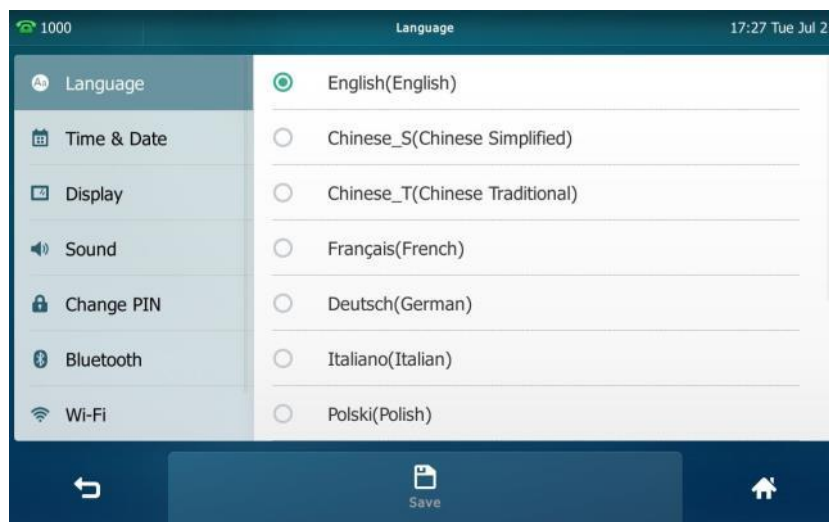

4. Tap the **Save** soft key to accept the change.
Text displayed on the phone user interface will change to the selected language.

To change the language for the web user interface:

1. Click on **Settings**->**Preference**.
2. Select the desired language from the pull-down list of **Language**.

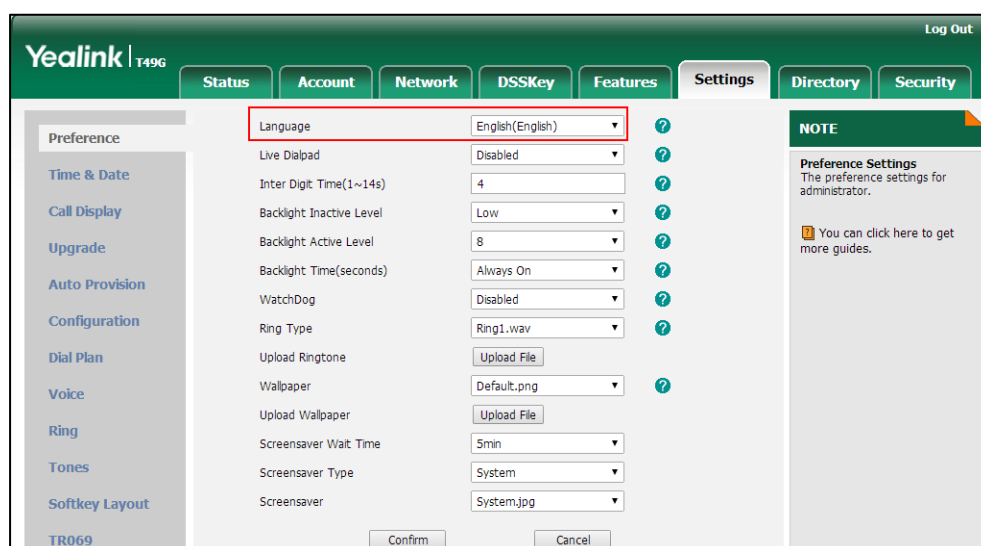

3. Click **Confirm** to accept the change.
Text displayed on the web user interface will change to the selected language.

Time & Date

The time and date are displayed in the center of screen. You can configure the phone to obtain the time and date from the SNTP server automatically, or configure the time and date manually. If the phone cannot obtain the time and date from the Simple Network Time Protocol (SNTP) server, contact your system administrator for more information.

To configure the SNTP setting via phone user interface:

1. Tap  -> **Basic**->**Time & Date**->**General**.
2. Tap the **Type** field.
3. Tap **SNTP Settings** in the pop-up dialog box.
4. Tap the **Time Zone** field.
5. Tap the time zone that applies to your area in the pop-up dialog box.
The default time zone is "+8".
6. Enter the domain name or IP address of SNTP server in the **NTP Server1** and **NTP Server2** field respectively.
7. Tap the **Daylight Saving** field.
8. Tap the desired value in the pop-up dialog box.
9. Tap the **Location** field.
This field appears only if **Daylight Saving** field is selected to **Automatic**.
10. Tap the desired time zone name in the pop-up dialog box.
The default time zone name is "China(Beijing)".



11. Tap the **Save** soft key to accept the change or  to cancel.

Note

Please refer to [Appendix A - Time Zones](#) for the list of available time zones on the IP phone.

To configure the time and date manually via phone user interface:

1. Tap  -> **Basic**->**Time & Date**->**General**.
2. Tap the **Type** field.
3. Tap **Manual Settings** in the pop-up dialog box.
4. Enter the specific date and time in the corresponding fields.

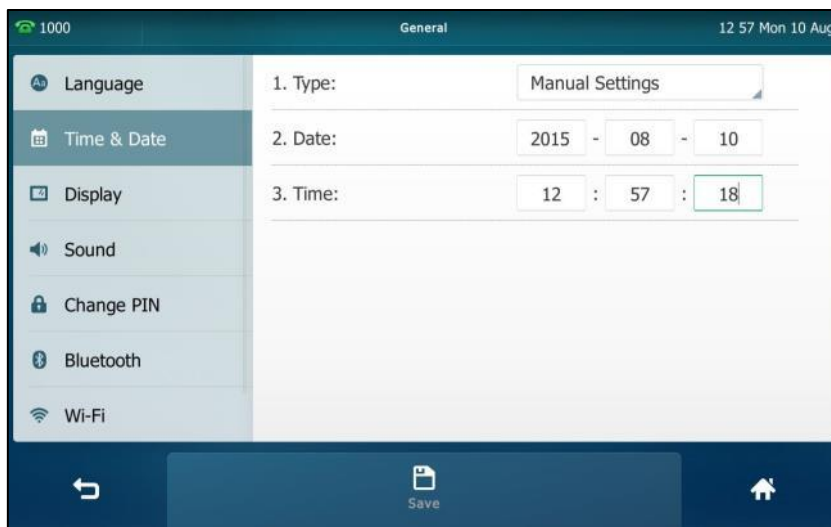

5. Tap the **Save** soft key to accept the change.

The time and date displayed on the touch screen will change accordingly.

There are 7 available date formats. For example, for the date format “WWW DD MMM”, “WWW” denotes the abbreviation of the weekday, “DD” denotes the two-digit day, and “MMM” denotes the first three letters of the month.

The date formats available:

Date Format	Example (2015-08-10)
WWW MMM DD	Mon Aug 10
DD-MMM-YY	10-Aug-15
YYYY-MM-DD	2015-08-10
DD/MM/YYYY	10/08/2015
MM/DD/YY	08/10/15
DD MMM YYYY	10 Aug 2015
WWW DD MMM	Mon 10 Aug

To configure the date and time format via phone user interface:

1. Tap  -> **Basic**->**Time & Date**->**Time & Date Format**.
2. Tap the **Date Format** field.
3. Tap the desired date format in the pop-up dialog box.

4. Tap the **Time Format** field.
5. Tap the desired time format (**12 Hour** or **24 Hour**) in the pop-up dialog box.

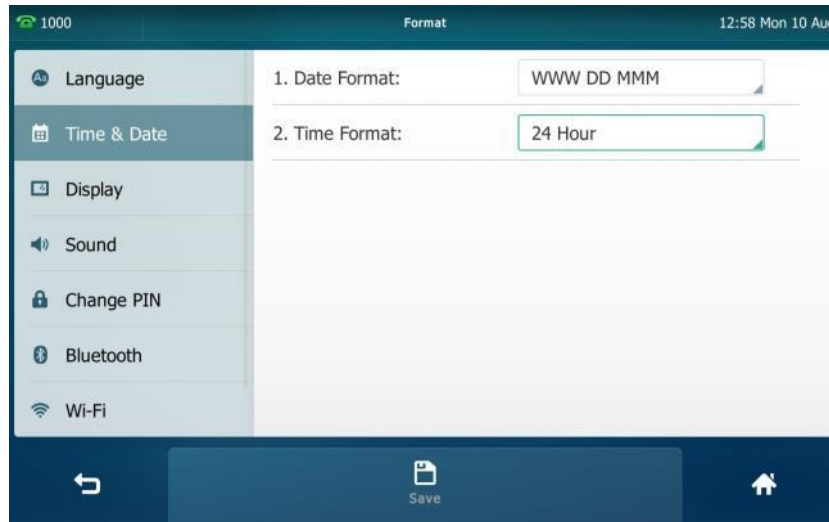

6. Tap the **Save** soft key to accept the change or  to cancel.

Time and date are configurable via web user interface at the path **Settings->Time & Date**.

Administrator Password

The Advanced option is only accessible to the administrator. The default administrator password is "admin". For security reasons, you should change the default administrator password as soon as possible.

To change the administrator password via phone user interface:

1. Tap  -> **Advanced** (default password: admin) -> **Set Password**.
2. Enter the old password in the **Current PWD** field.
3. Enter the new password in the **New PWD** field.

4. Re-enter the new password in the **Confirm PWD** field.

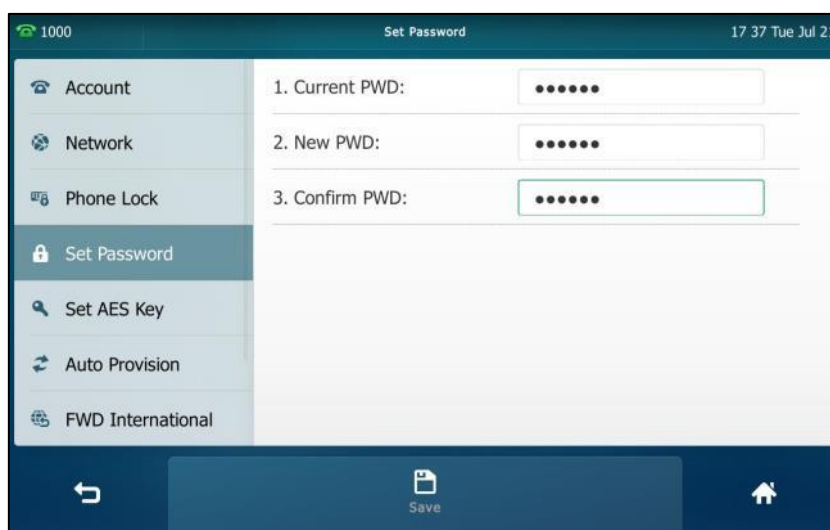

5. Tap the **Save** soft key to accept the change or  to cancel.

Administrator password is configurable via web user interface at the path **Security->Password**.

Key as Send

You can set the "#" key or "*" key to perform as a send key while dialing.

To configure key as send via phone user interface:

1. Tap  -> **Features->General**.
2. Tap the **Key as Send** field.
3. Tap # or * in the pop-up dialog box, or tap **Disabled** to disable this feature.

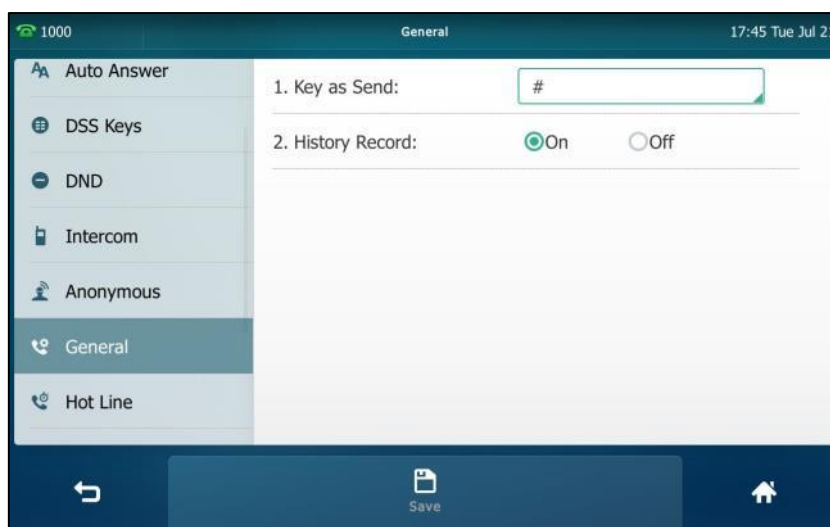

4. Tap the **Save** soft key to accept the change or  to cancel.

Key as send is configurable via web user interface at the path **Features->General Information**.

Phone Lock

You can lock your phone temporarily when you are not using it. This feature helps to protect your phone from unauthorized use.

When the phone is locked, the following you needed to know:

All keys are locked except the Volume key, digit keys, # key, * key and Speakerphone key. You are only allowed to dial emergency numbers, reject incoming calls by tapping the **Reject** soft key, answer incoming calls by lifting the handset, pressing the Speakerphone key, the HEADSET key or tapping the **Answer** soft key, and end the call by hanging up the handset, pressing the Speakerphone key or tapping the **EndCall** soft key.

Note

The emergency number setting, if desired, must be made before lock activation. For more information, refer to [Emergency Number](#) on page 151.

To activate the phone lock via phone user interface:

1. Tap  -> **Advanced** (default password: admin) -> **Phone Lock**.
2. Tap the **Lock Enable** field.
3. Tap **Enabled** in the pop-up dialog box to enable this feature.
4. Enter the desired interval of automatic phone lock in the **Lock Time Out** field.

The default timeout is 0. It means the phone will not be automatically locked. You need to long press  to lock it immediately when the phone is idle.

If set to other values except 0 (e.g., 5), the phone will be locked when the phone is inactive in idle screen for the designated time (in seconds).

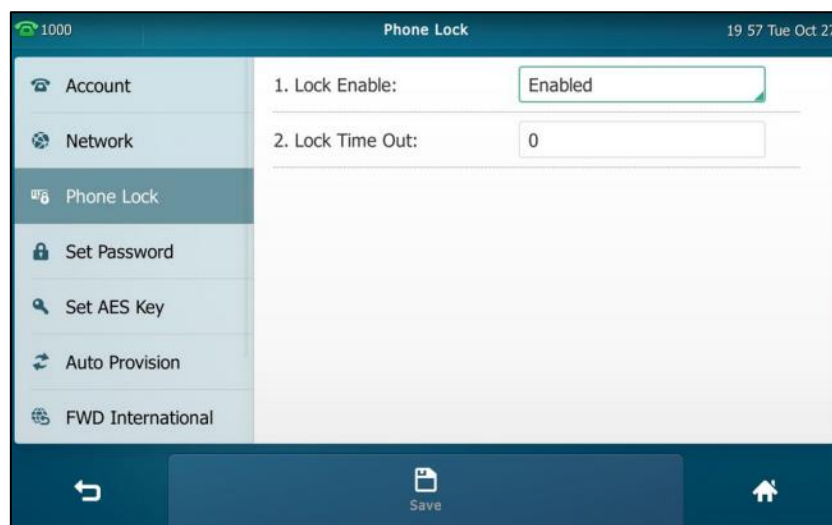

5. Tap the **Save** soft key to accept the change.

When the phone is locked, the touch screen prompts “Phone locked.” and displays the icon  on the status bar of the touch screen.

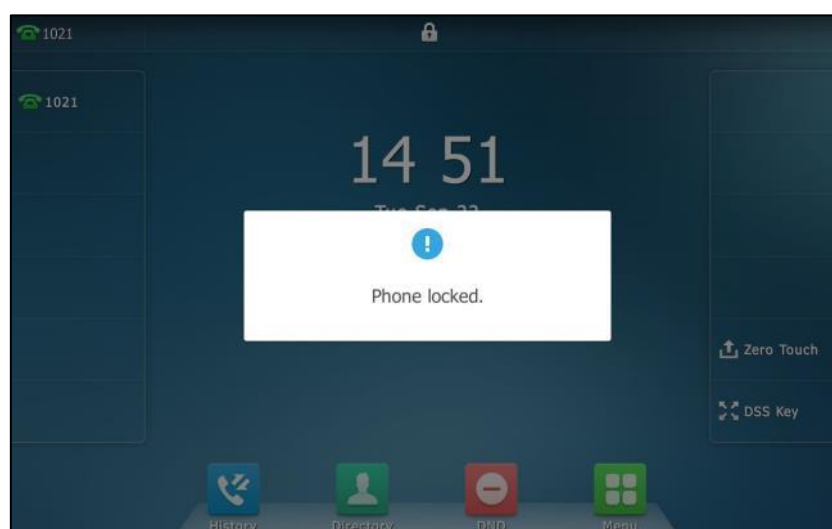

To unlock the phone, you must know the phone unlock PIN. The default phone unlock PIN is “123”.

To change the phone unlock PIN via phone user interface:

1. Tap  -> **Basic**->**Change PIN**.
2. Enter the desired value in the **Current PIN**, **New PIN** and **Confirm PIN** field respectively.

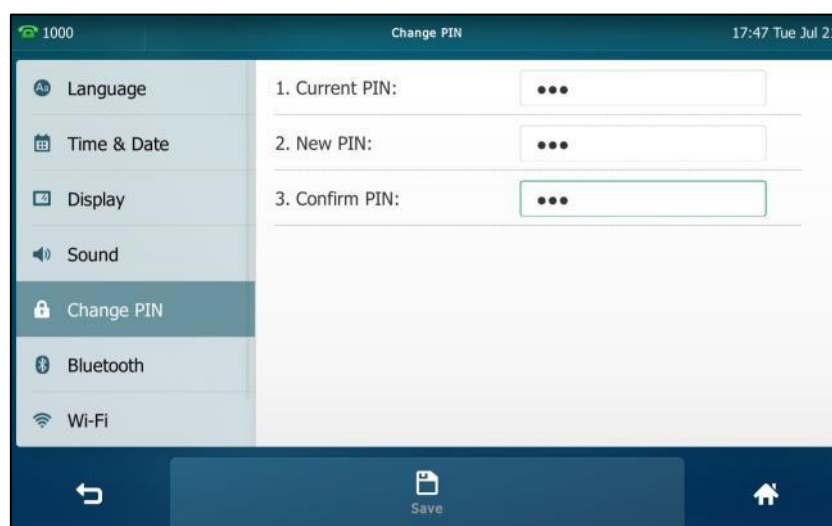

3. Tap the **Save** soft key to accept the change or  to cancel.

Note The unlock PIN length must be within 15 digits.

To unlock the phone via phone user interface:

1. Tap the locked key, the touch screen prompts "Unlock PIN".
2. Enter the PIN in the **Unlock PIN** field.

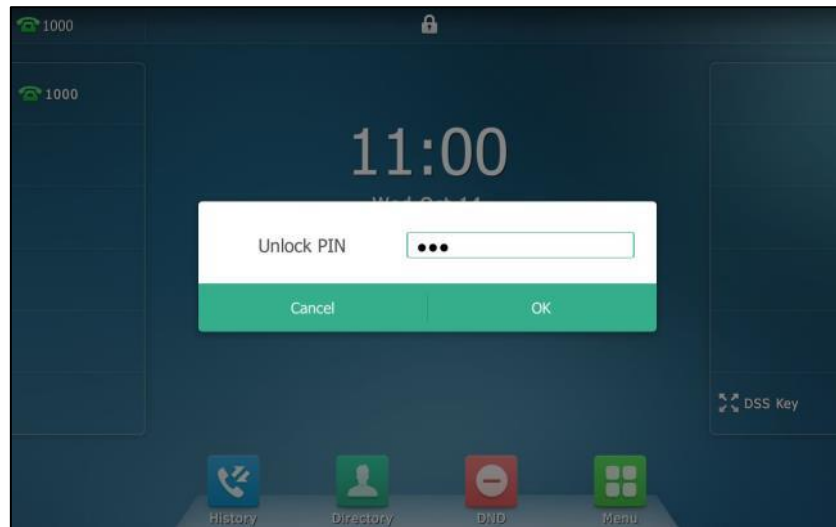

3. Press **OK** to unlock the phone.

The icon  disappears from the touch screen.

You can long press  or wait for a period of time (if configured) to lock the phone again.

Note

You can also unlock the phone by administrator password. When you enter the administrator password to unlock the phone, the phone will turn to the Change PIN screen.

To deactivate the phone lock via phone user interface:

1. Tap  -> **Advanced** (default password: admin) -> **Phone Lock**.
2. Tap the **Lock Enable** field.

3. Tap **Disabled** in the pop-up dialog box to disable this feature.

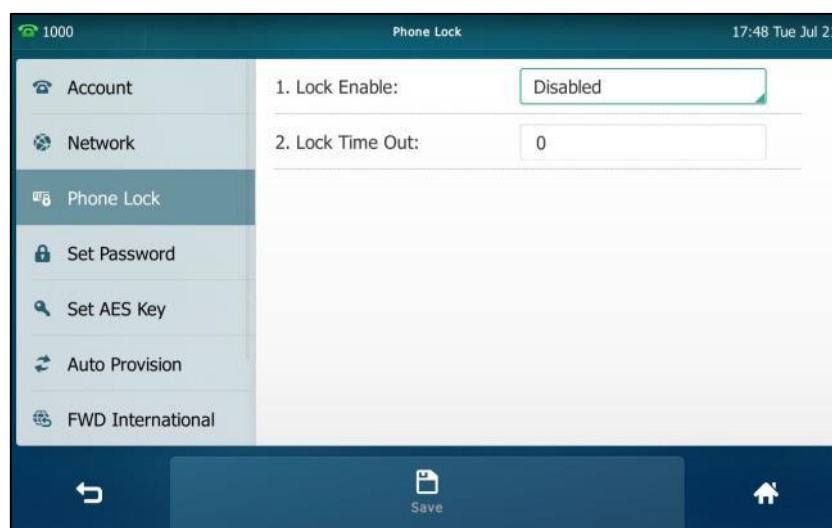

4. Tap the **Save** soft key to accept the change.

Phone lock is configurable via web user interface at the path **Features->Phone Lock**.

Audio Settings

Volume

You can press the Volume key to adjust the ringer volume when the phone is idle or ringing. You can also press the Volume key to adjust the receiver volume of currently engaged audio devices (handset, speakerphone or headset) when the phone is in use.

To adjust the volume:

When the phone is idle:

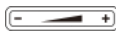
1. Press  to adjust the ringer volume.

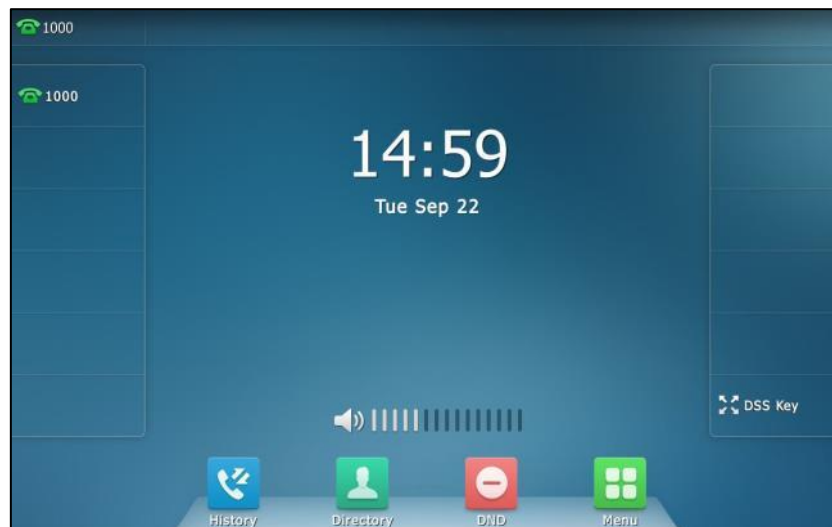

When the phone is ringing:

1. Press  to adjust the ringer volume.

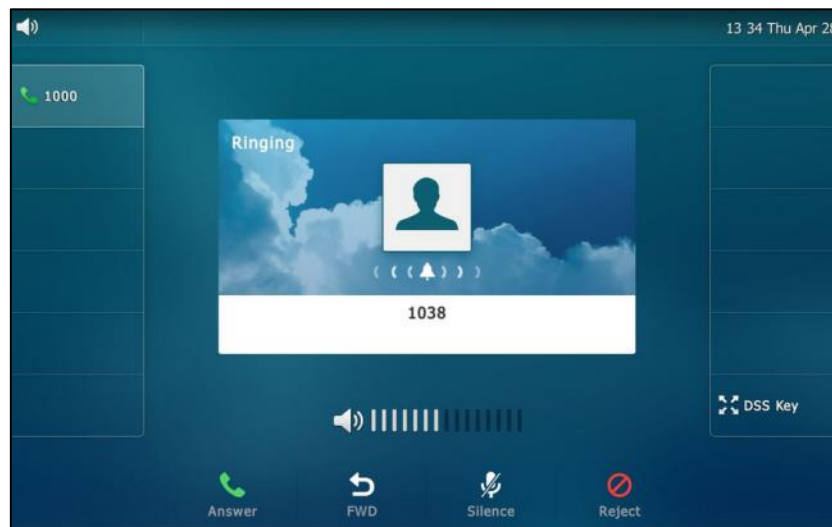

You can also press  to adjust the ringer volume when selecting a ring tone. For more information, refer to [Ring Tones](#) on page 80.

Note

If the ringer volume is adjusted to minimum, the icon  will appear on the touch screen.

To adjust the volume when the phone is during a call:

1. Press  to adjust the volume of currently engaged audio device (handset, speakerphone or headset).

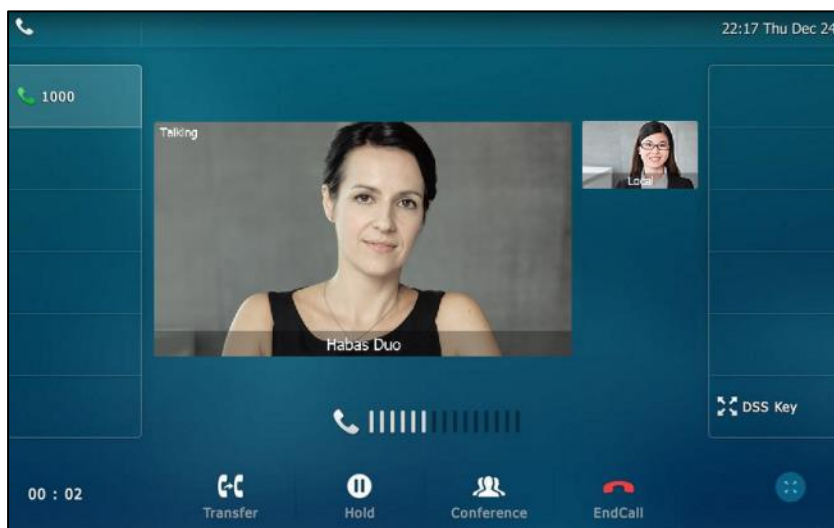



Ring Tones

Ring tones are used to indicate incoming calls. You can select different ring tones to distinguish different accounts registered on your phone, or to distinguish your phone from your neighbor's.

To select a ring tone for the phone via phone user interface:

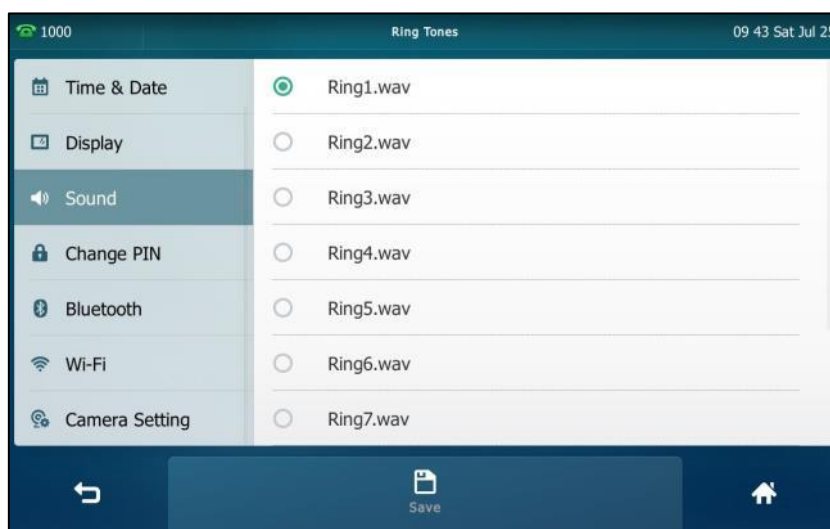
1. Tap  -> **Basic**->**Sound**->**Ring Tones**->**Common**.
2. Tap the desired ring tone.



3. (Optional.) Press  to adjust the ringer volume.
4. Tap the **Save** soft key to accept the change or  to cancel.



A ring tone for the phone is configurable via web user interface at the path **Settings->Preference->Ring Type**.

To select a ring tone for the account via phone user interface:

1. Tap  -> **Basic->Sound->Ring Tones**.
2. Tap the desired account.
3. Tap the desired ring tone.

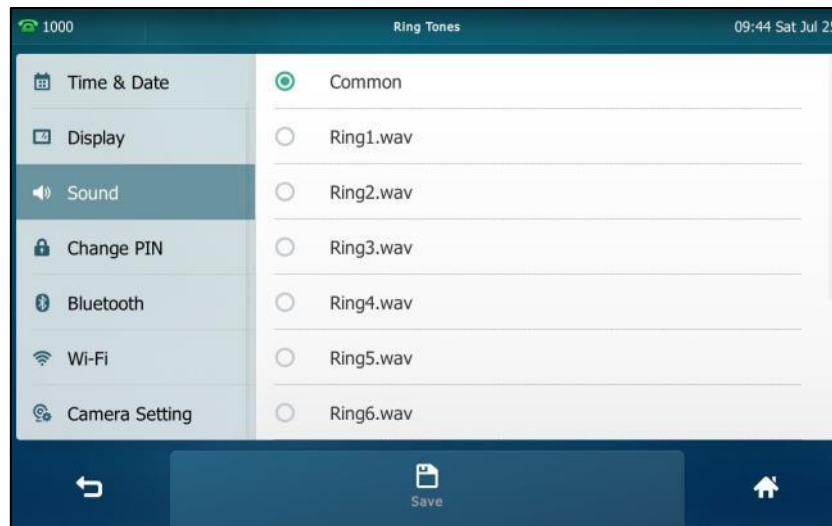
If **Common** is selected, this account will use the ring tone selected for the phone.



4. (Optional.) Press  to adjust the ringer volume.
5. Tap the **Save** soft key to accept the change or  to cancel.

A ring tone for the account is configurable via web user interface at the path **Account->Basic->Ring Type**.

To upload a custom ring tone for your phone via web user interface:

1. Click on **Settings->Preference**.

2. In the **Upload Ringtone** field, click **Upload File** to locate and upload a ring tone file (the file format must be *.wav) from your local system.

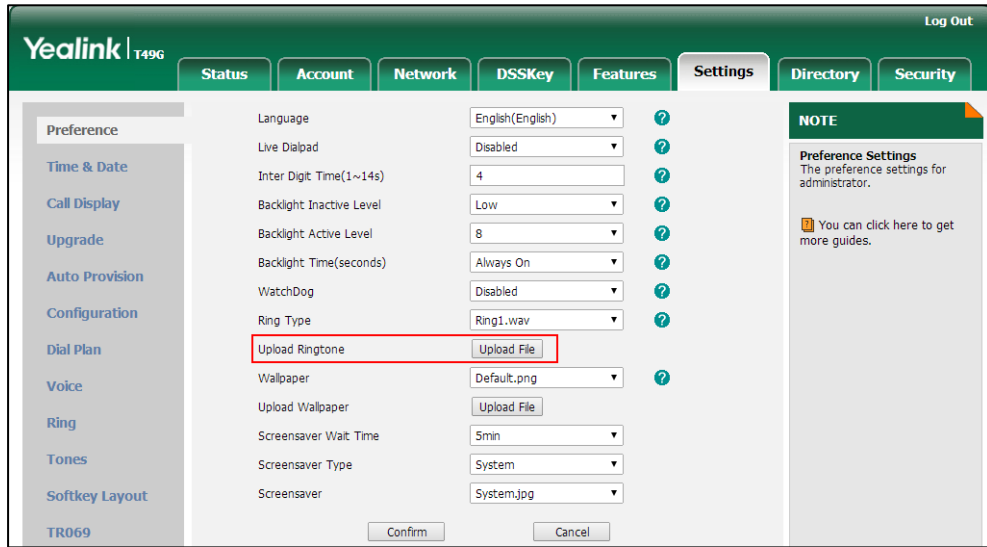

The web user interface prompts “Upload success!”. The custom ringtone appears in **Ring Type** list. You can only delete the custom ringtone by clicking **Del** in the **Ring Type** field.

Note

The priority of ring tone for an incoming call on the phone is as follows:
Contact ring tone (refer to [Adding Contacts](#)) > Group ring tone (refer to [Adding Groups](#)) > Account ring tone > Phone ring tone.

Single custom ring tone file must be within 8MB and total custom ring tone files must be within 20MB. Uploading custom ring tones for your phone is configurable via web user interface only.

Contact Management

This section provides the operating instructions for managing contacts. Topics include:

- [Local Directory](#)
- [Blacklist](#)
- [Remote Phone Book](#)
- [Mobile Contacts](#)

Local Directory

The built-in phone directory can store the names and phone numbers of your contacts. You can store up to 1000 contacts and 48 groups in your phone's local directory. You can add new groups and contacts, edit, delete or search for a contact, or simply dial a

contact number from the local directory.

Adding Groups

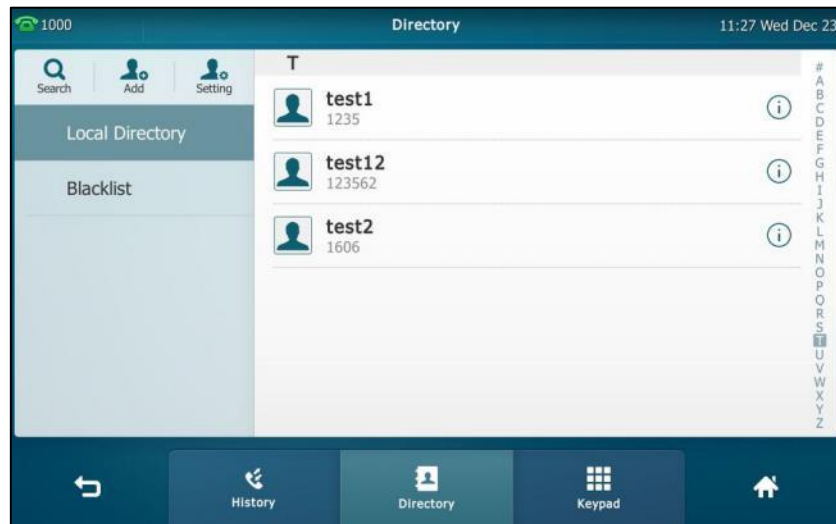

To add a group to the local directory:

1. Tap .

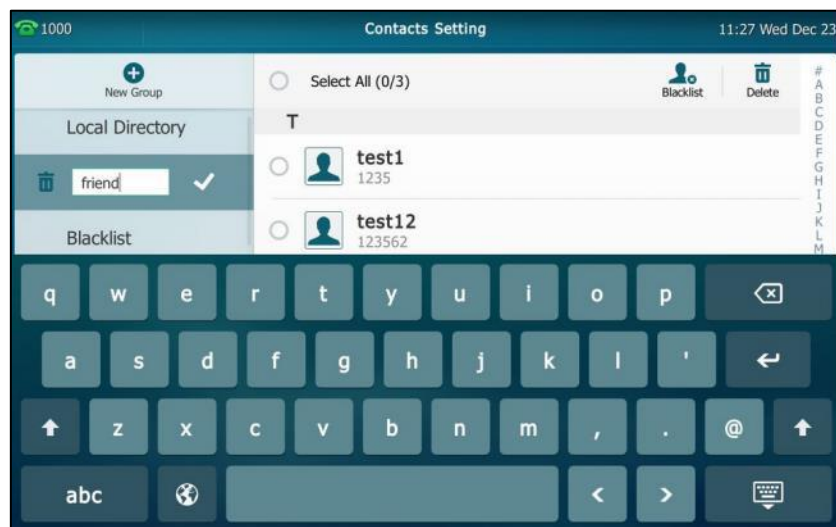

2. Tap **Setting**.
3. Tap **New Group**.
4. Enter the desired group name in the highlighted field.



5. Tap  to accept the change.
6. Tap  to specify a ring tone for the group.

7. Tap the desired ring tone in the pop-up dialog box.

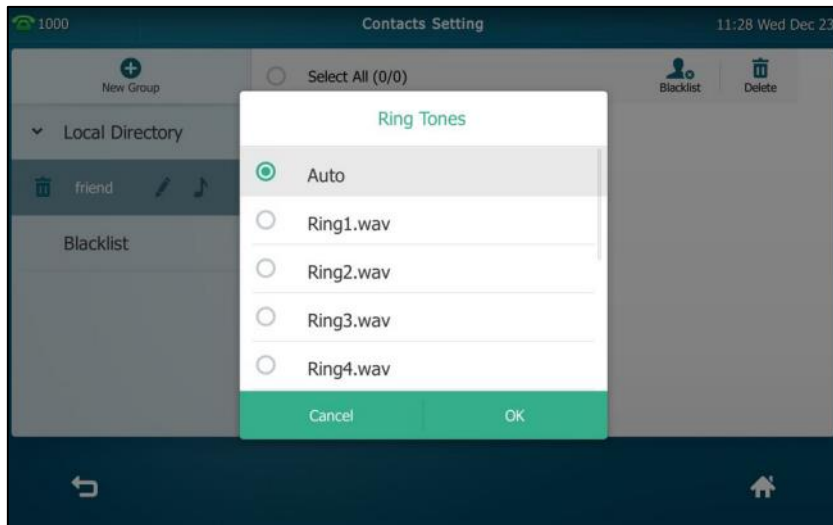

If **Auto** is selected, this group will use the ring tone according to the priority: Contact ring tone (refer to [Adding Contacts](#)) >Account ring tone (refer to [Ring Tones](#)) >Phone ring tone (refer to [Ring Tones](#)). If a specific ring tone is selected, this group will use the ring tone according to the priority: Contact ring tone (refer to [Adding Contacts](#)) >Group ring tone.

8. Tap **OK** to accept the change.
You can also edit or delete any newly added contact groups.

Editing Groups

To edit a group in the local directory:

1. Tap  .

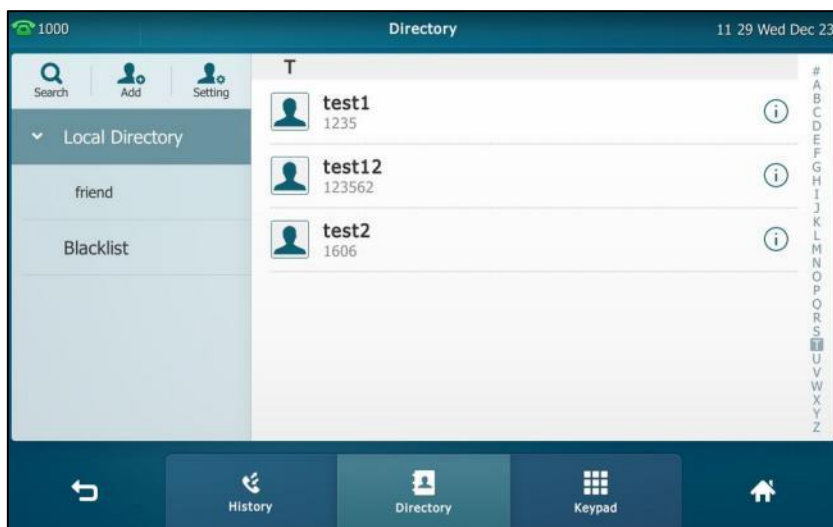

2. Tap **Setting**.
3. Tap the desired group.

4. Tap  after the group name.

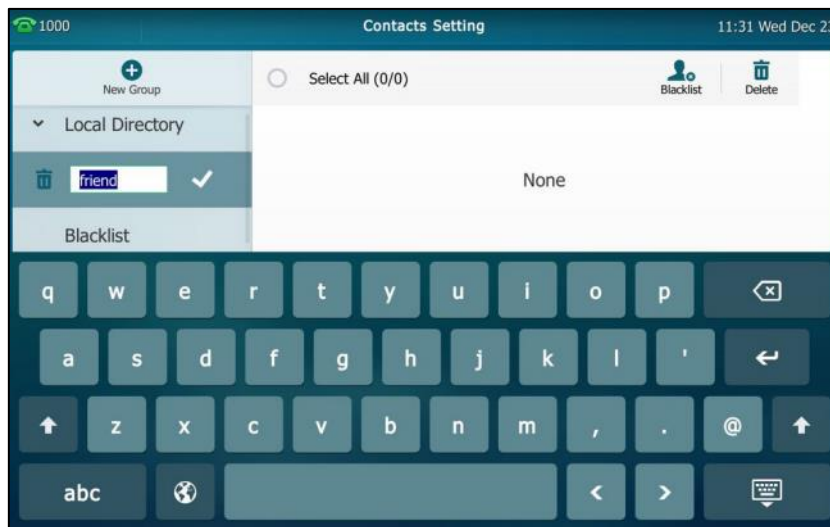



5. Edit the group name in the highlighted field.
6. Tap  to accept the change.

Deleting Groups

To delete a group from the local directory:

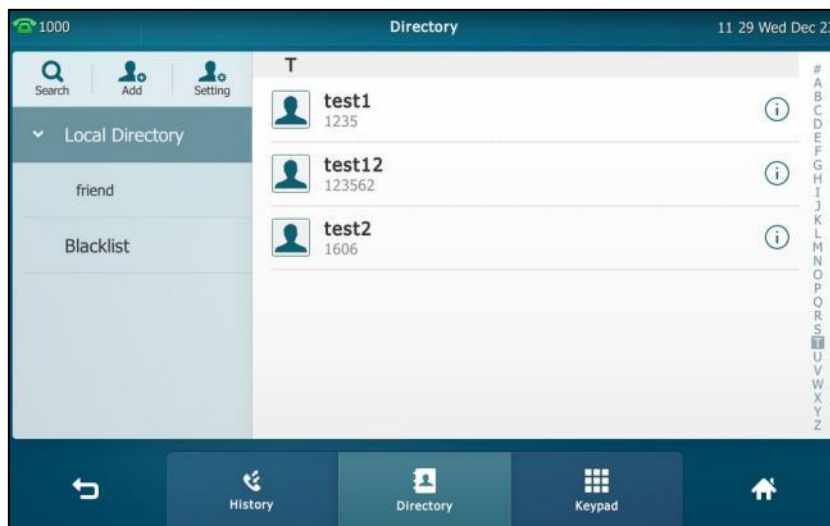
1. Tap .



2. Tap **Setting**.
3. Tap  before the desired group name.

The touch screen prompts the following warning:

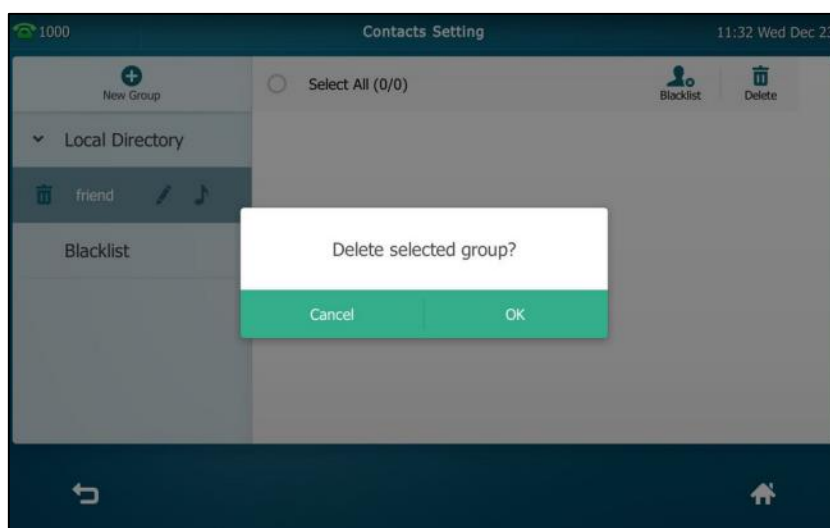

4. Tap **OK** to accept the change or **Cancel** to cancel.

Adding Contacts

You can add contacts to the local directory in one of the following ways:

- Manually
- From call history
- From a remote phone book

Adding Contacts Manually

To add a contact to the local directory manually:

1. Tap  .

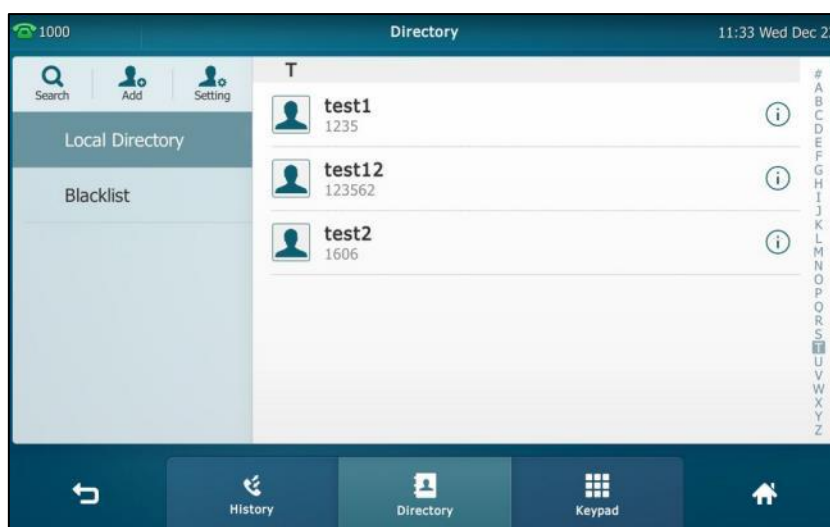

2. Tap **Add**.

If you want add a contact to the specified contact group, you can tap the contact group first, and then tap **Add**.

3. Enter the name and the office, mobile or other numbers in the corresponding fields.

4. Tap the **Account** field.
5. Tap the desired account in the pop-up dialog box.
If **Auto** is selected, the phone will use the default account when placing calls to the contact from the local directory.
6. Tap the **Ring** field.
7. Tap the desired ring tone in the pop-up dialog box.
If **Auto** is selected, this contact will use the ring tone according to the priority: Group ring tone (refer to [Adding Groups](#)) >Account ring tone (refer to [Ring Tones](#))>Phone ring tone (refer to [Ring Tones](#)).
8. Tap the **Photo** field.
9. Tap the desired photo in the pop-up dialog box.
10. Tap the **Save** soft key to accept the change or to cancel.

Note

If the contact already exists in the directory, the touch screen will prompt "Contact name existed!".

Adding Contacts from Call History

To add a contact to the local directory from call history:

1. Tap .
2. Drag up and down to view the list of history.

3. Tap  after the desired entry.

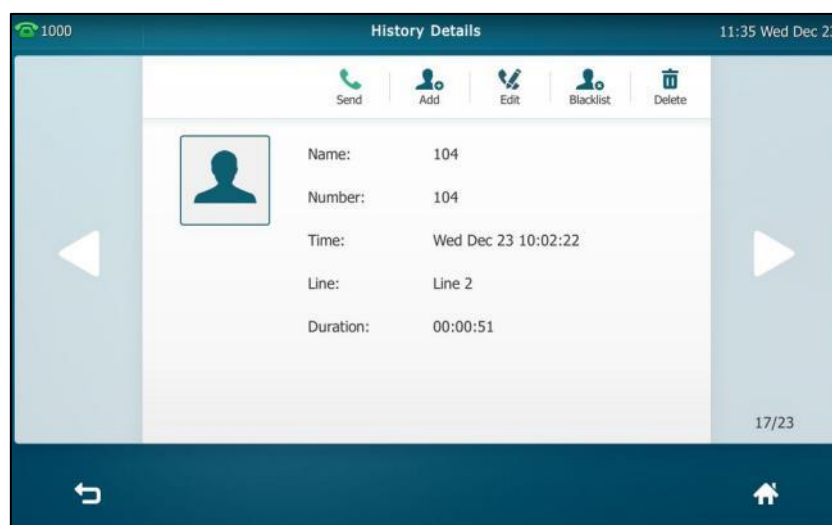

4. Tap **Add**.
5. Edit the corresponding fields.

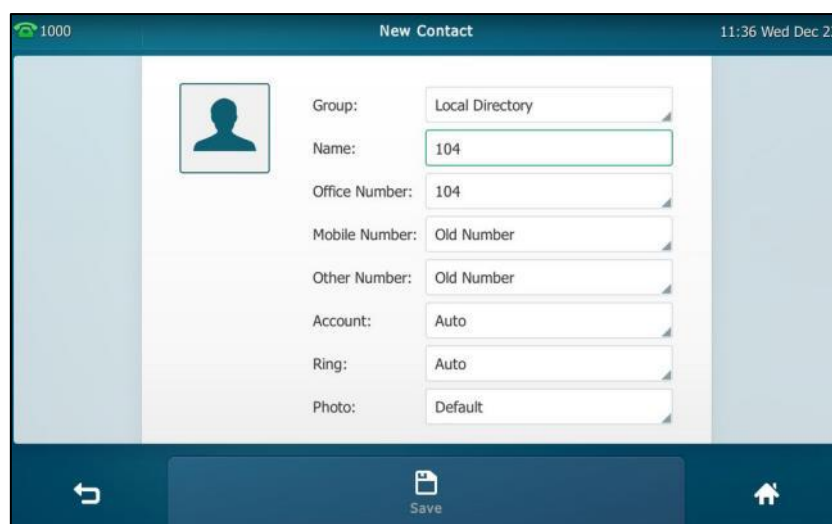



6. Tap the **Save** soft key to accept the change.
The entry is successfully saved to the local directory.

Adding Contacts from a remote phone book

To add a contact to the local directory from a remote phone book:

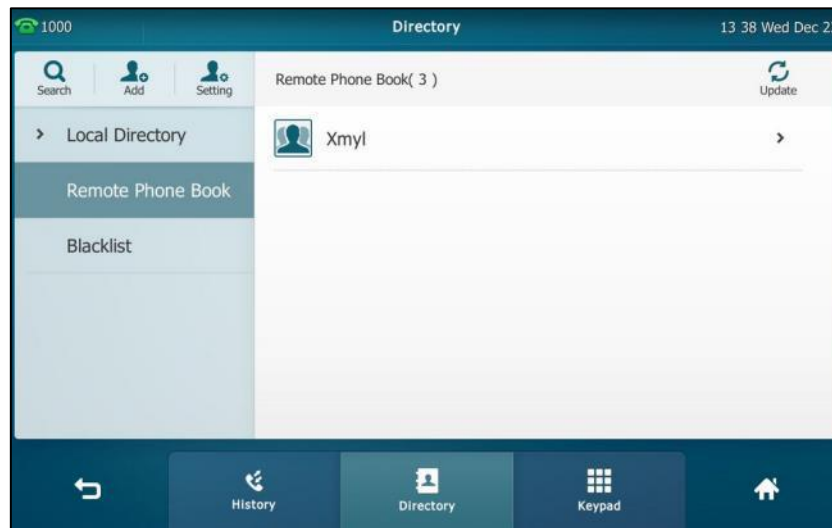
1. Tap  -> **Remote Phone Book** or tap  -> **Directory**-> **Remote Phone Book** to enter the remote phone book.



2. Tap the desired remote phone book.
The phone then connects to the remote phone book and proceeds to load it. The contacts in the remote phone book are displayed on the touch screen.
3. Tap  after the desired contact in the remote phone book.

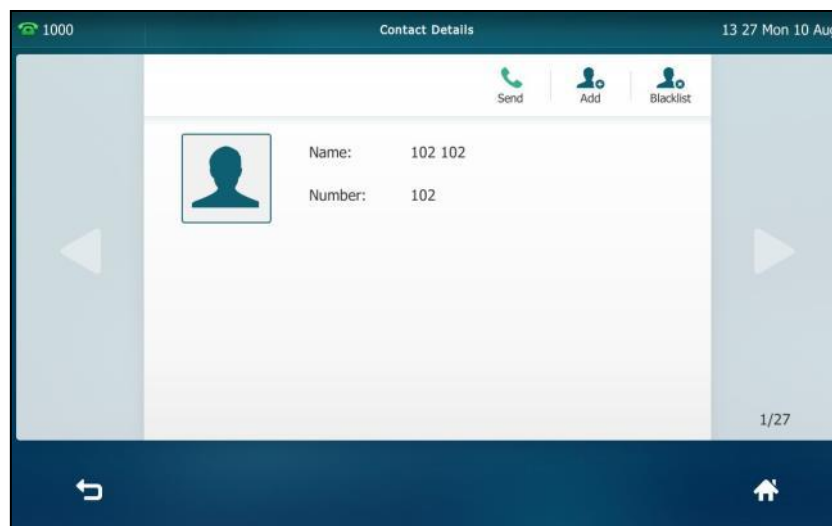

4. Tap **Add**.

5. Edit the corresponding fields.

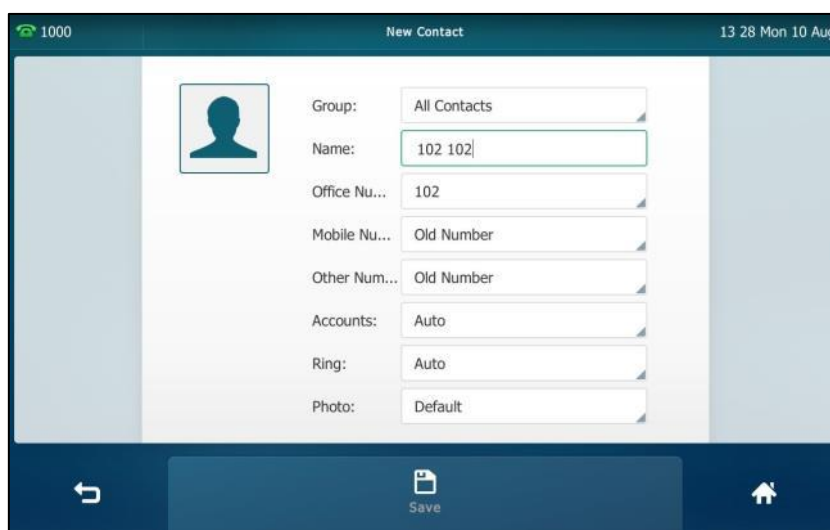

6. Tap the **Save** soft key to save the contact to the local directory.

If the contact already exists in the local directory, the touch screen will prompt "Overwrite the original contact?". Tap **OK** to overwrite the original contact in the local directory or **Cancel** to cancel.

For more information on remote phone book operation, refer to [Remote Phone Book](#) on page 104.

Editing Contacts

To edit a contact in the local directory:

1. Tap .

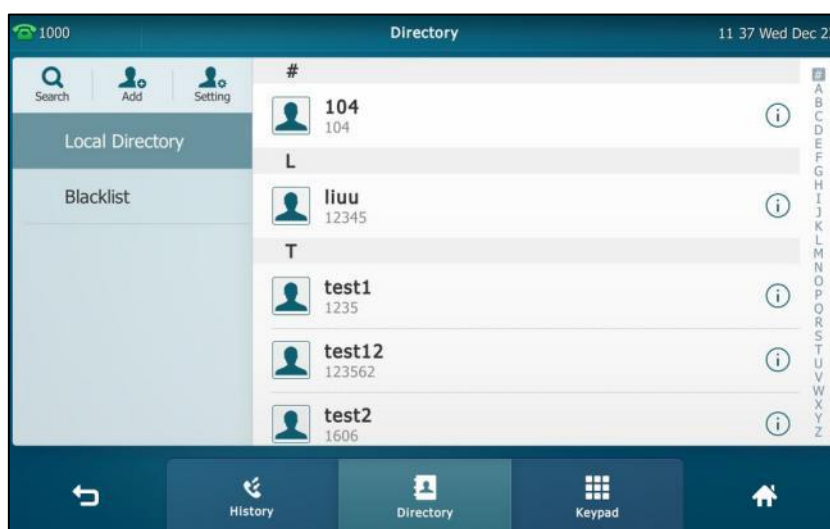

2. Tap  after the desired contact.

If the contact was added to a specified contact group, you can tap the contact group first, and then tap .

3. Tap the desired field to edit the contact information.

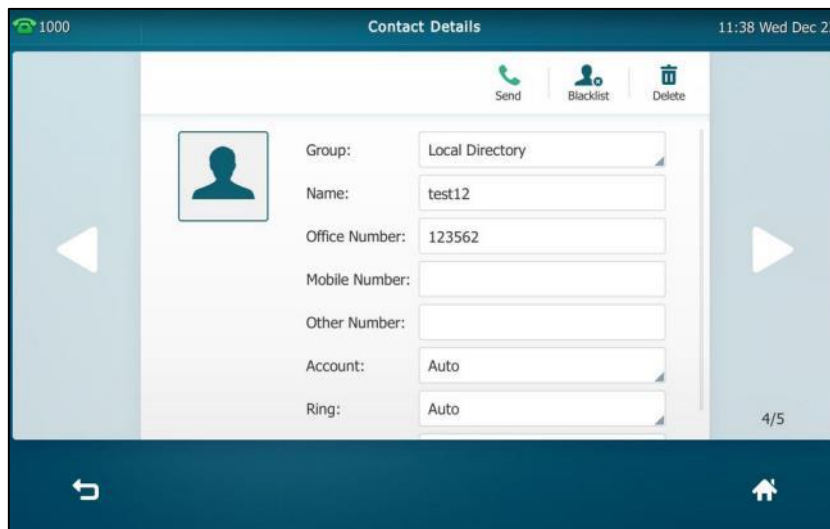

You can tap ◀ or ▶ to change the contact you want to edit.

4. Tap the **Save** soft key to accept the change or ↶ to cancel.

Deleting Contacts

To delete a contact from the local directory:

1. Tap .

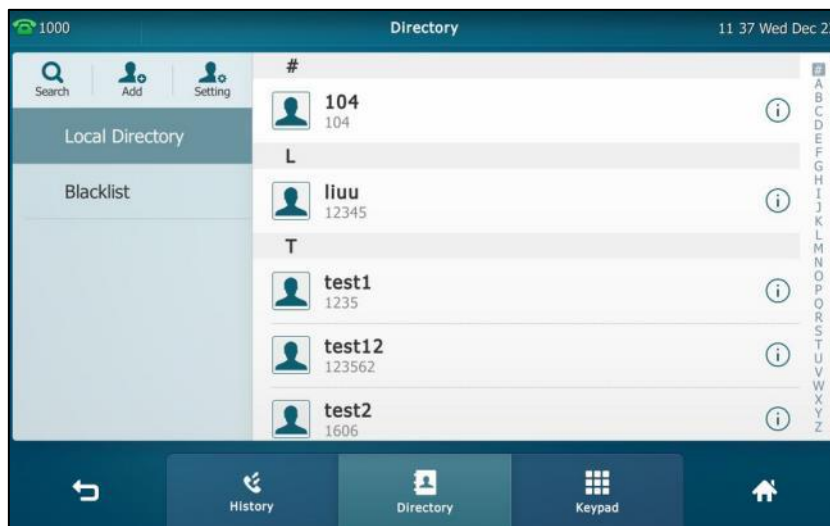

2. Tap  after the desired contact.

If the contact was added to a specified contact group, you can tap the contact group first, and then tap  after the desired contact.

3. Tap **Delete**.

The touch screen prompts the following warning:

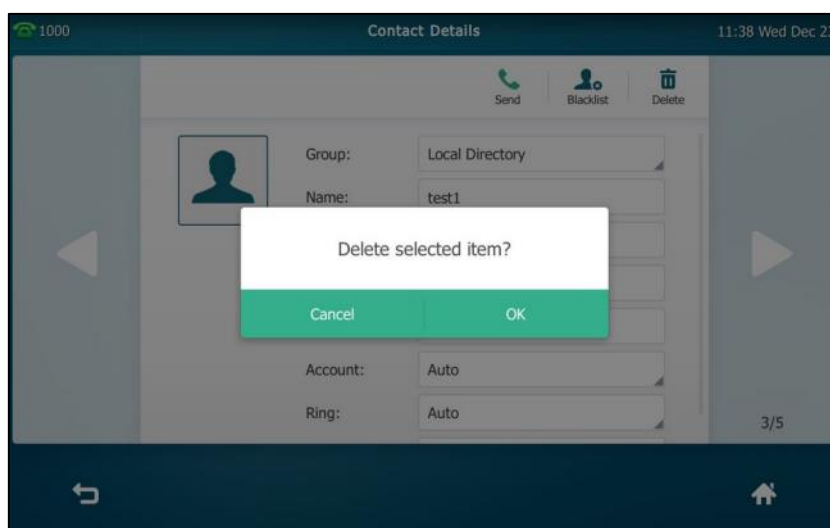

4. Tap **OK** to accept the change or **Cancel** to cancel.

To delete all contacts:

1. Tap  .

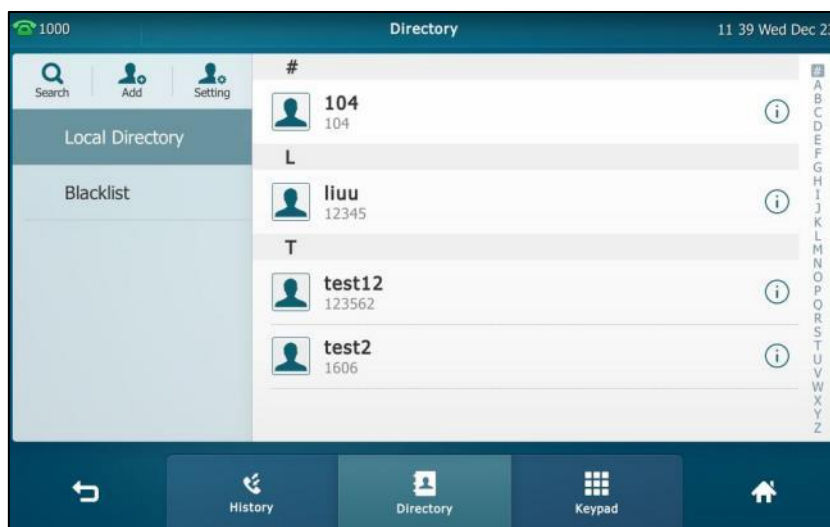

2. Tap **Setting**.
3. Tap the **Select All** checkbox.
4. Tap **Delete**.

The touch screen prompts the following warning:

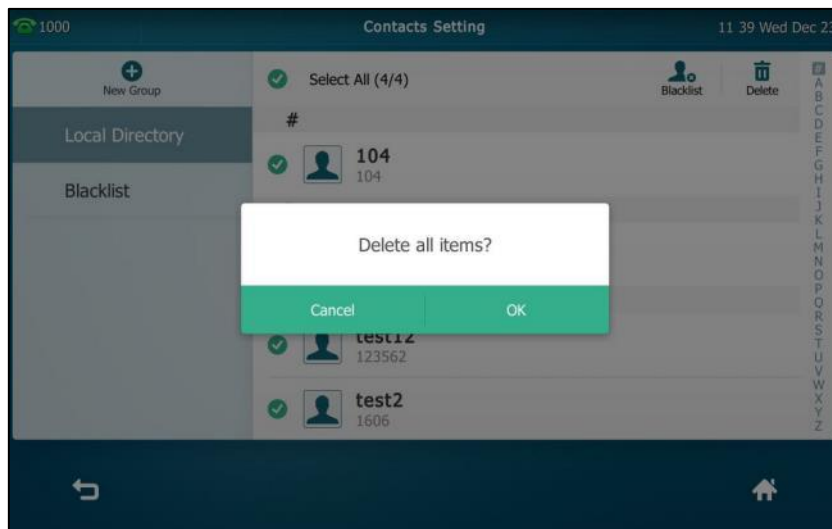

5. Tap **OK** to accept the change or **Cancel** to cancel.

Uploading Contact Photos

To upload a new custom photo for a contact via web user interface:

1. Click on **Directory->Local Directory**.
2. Click **Upload Photo**, and then locate and upload a photo file from your local computer.

The web user interface prompts "Upload success!".

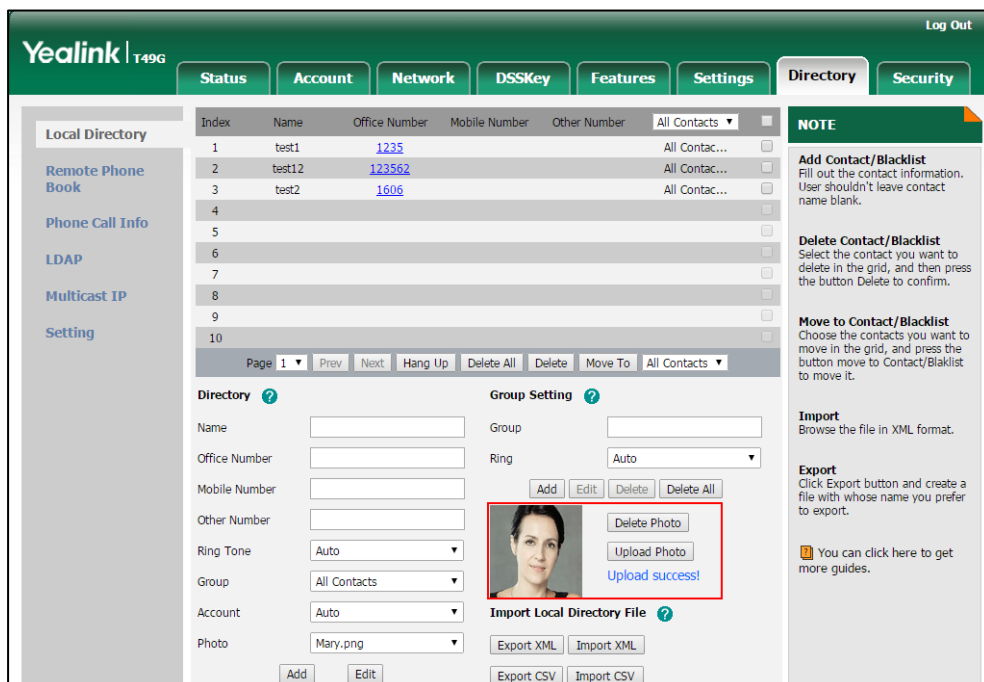

You can click **Delete Photo** to delete the custom photo.

Note

The phone only supports *.png, *.jpg and *.bmp format files. The file size must be less than 2M.

You can only delete custom photos.

To change the custom photo for the contact via web user interface:

1. Click on **Directory->Local Directory**.
2. Click the desired contact you want to edit.
3. Select the desired photo from the pull-down list of **Photo**.

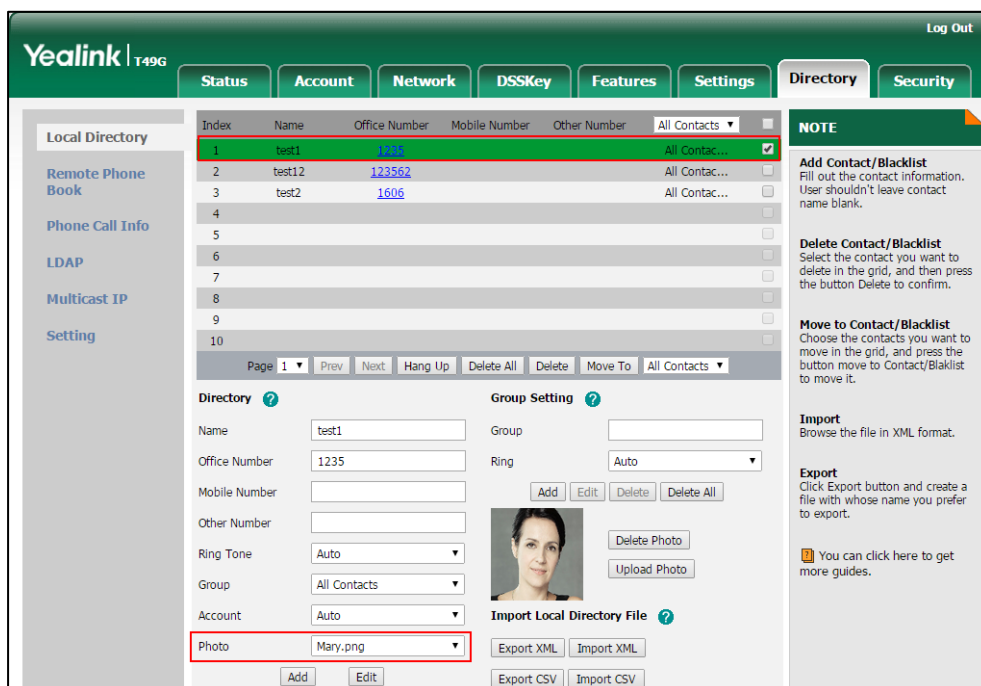

4. Click **Edit** to accept the change.

When you place a call to the contact or receive a call from the contact, the touch screen will display the contact photo.

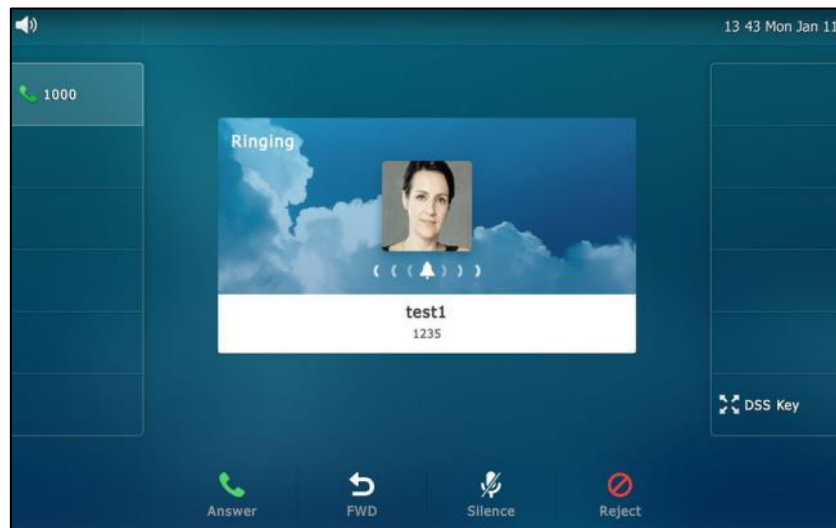

Placing Calls to Contacts

To place a call to a contact from the local directory:

1. Tap .

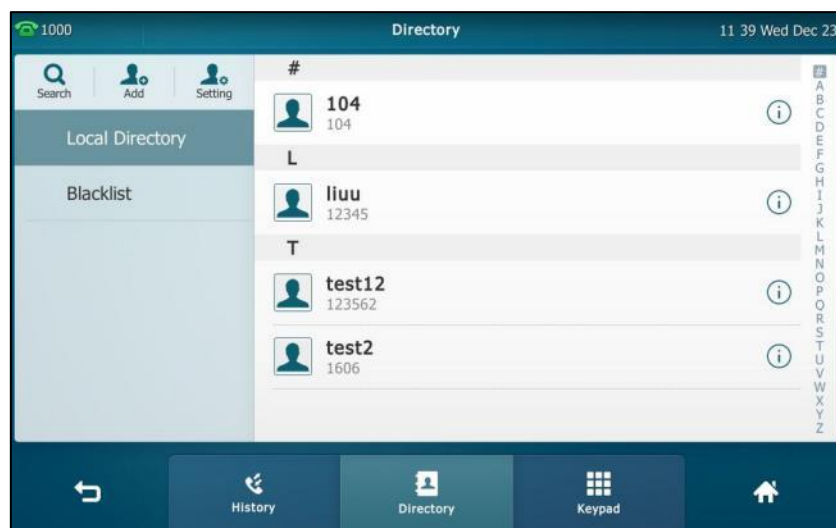

2. If the contact was added to a specified contact group, you can tap the contact group first, and then do one of the following:
 - Tap the desired contact.
 - If only one number for the contact is stored in the local directory, the number is being dialed out.
 - If multiple numbers for the contact are stored in the local directory, tap the desired number to dial out.
 - Tap  after the desired contact.

- If only one number for the contact is stored in the local directory, tap **Send** to dial out the number.
- If multiple numbers for the contact are stored in the local directory, tap **Send** to display a list of numbers.

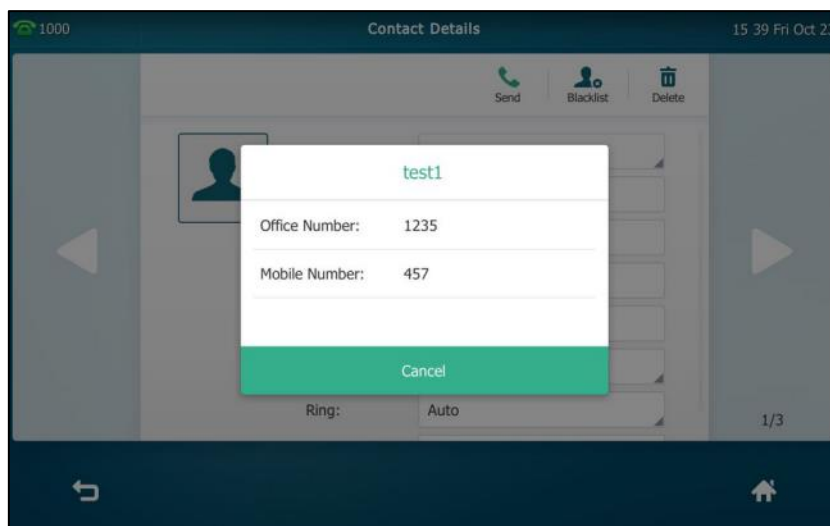

Tap the desired number to dial out.

Searching for Contacts

To search for a contact in the local directory:

1. Tap  .

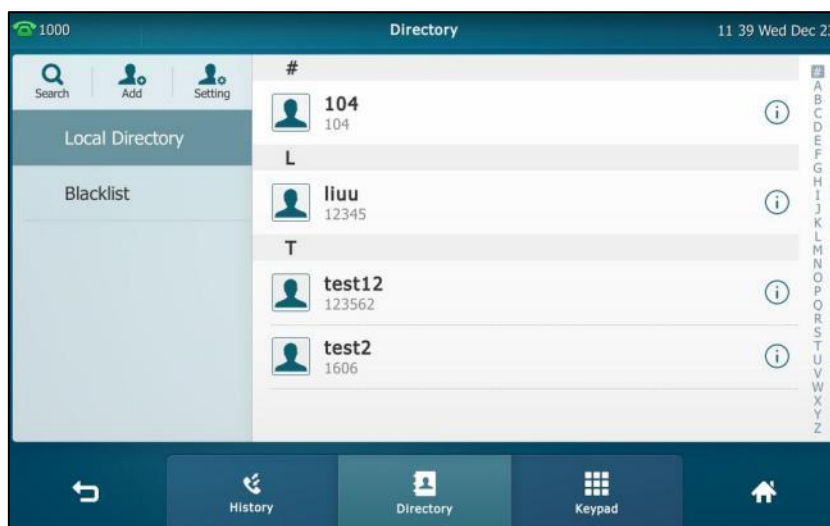

2. Do one of the following :
 - Tap **Search**.

Enter a few continuous characters of the contact name or continuous numbers of the contact number (office, mobile or other number) using the onscreen keyboard.

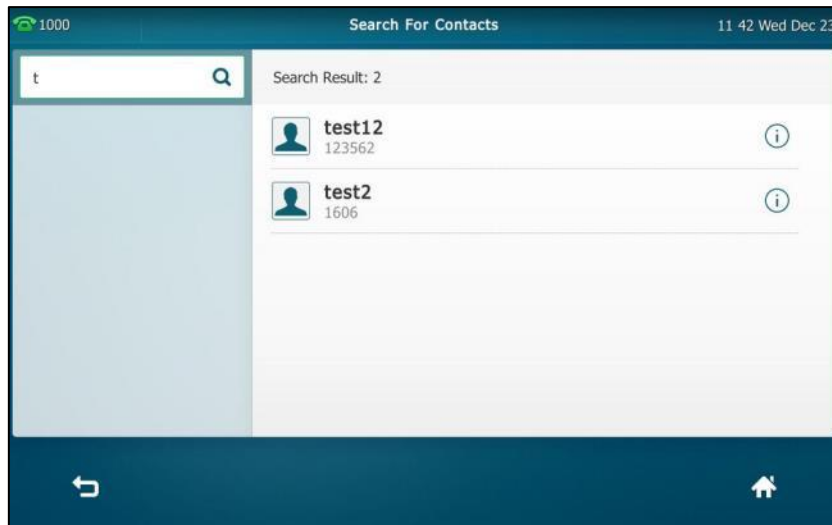

The contacts whose name or phone number matches the characters entered will appear on the touch screen. You can dial from the result list.

- Tap the desired letter (e.g., T) along the right side to jump to contacts whose names start with T.

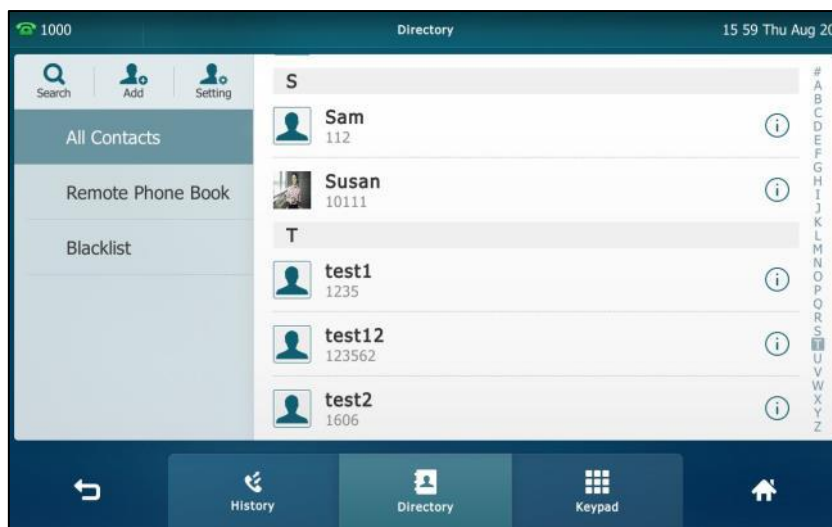





Drag up and down to select the desired contact to view or dial out.

Search Source List in Dialing

You can search for a contact from the desired lists when the phone is on the dialing screen. The lists can be Local Directory, History, Remote Phone Book and LDAP.

To configure search source list in dialing via web user interface:

1. Click on **Directory->Setting**.
2. In the **Search Source List In Dialing** block, select the desired list from the **Disabled** column and click  .
The selected list appears in the **Enabled** column.
3. Repeat the step 2 to add more lists to the **Enabled** column.
4. (Optional.) To remove a list from the **Enabled** column, select the desired list and then click  .
5. To adjust the display order of the enabled list, select the desired list, and click  or  .

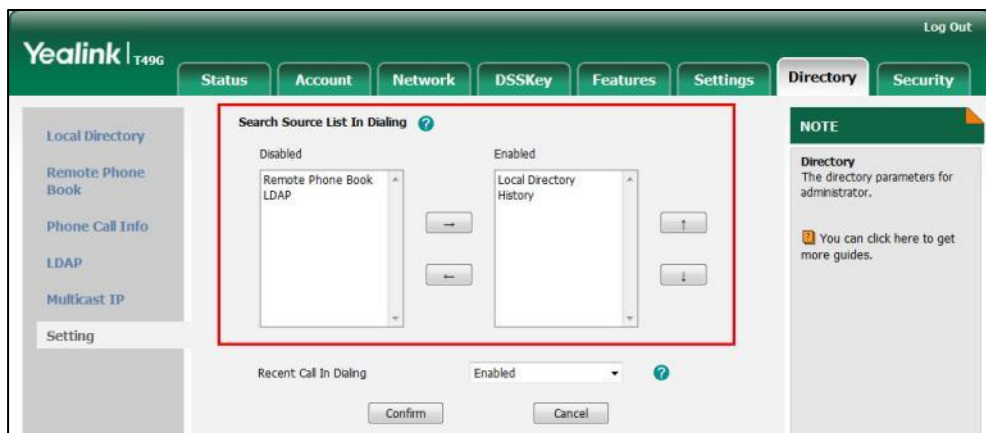

6. Click **Confirm** to accept the change.
The touch screen will display search results in the adjusted order.

Note Search source list in dialing is configurable via web user interface only.

To search for an entry in the enabled search source lists:

1. Pick up the handset, press the Speakerphone key or tap the line key.
2. Enter a few continuous characters of the entry's name or continuous numbers of the entry's phone number (office, mobile or other number).
The entries in the enabled search source lists whose name or phone number matches the characters entered will appear on the touch screen.

You can tap the desired entry to place a call to the entry.

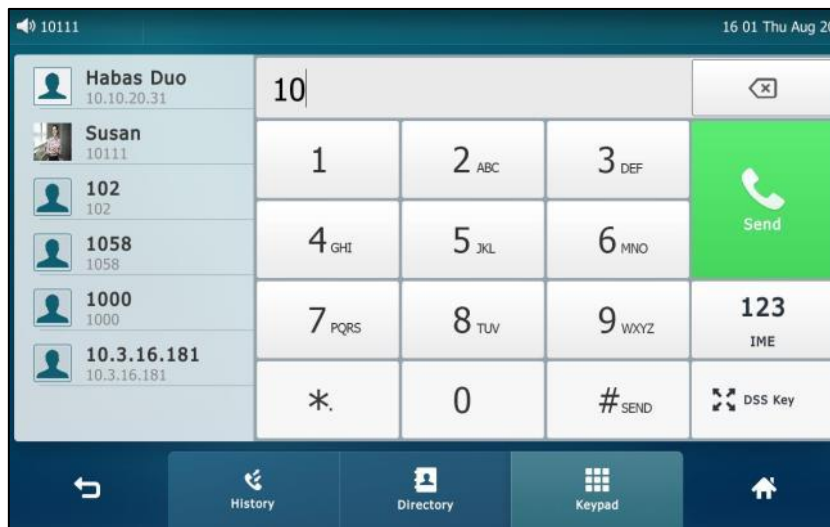

Note

If you connect a Bluetooth-Enabled mobile phone to the IP phone, and enable the IP phone to sync phone contacts. The IP phone will first search the contacts in the mobile contacts directory then placed calls list. For more information, refer to [Mobile Contacts](#) on page 106.

Importing/Exporting Contact Lists

You can manage your phone's local directory via phone user interface or web user interface. But you can only import or export the contact list via web user interface.

To import an XML contact list file via web user interface:

1. Click on **Directory->Local Directory**.

2. Click **Import XML** to locate and upload a contact list file (the file format must be *.xml) from your local system.

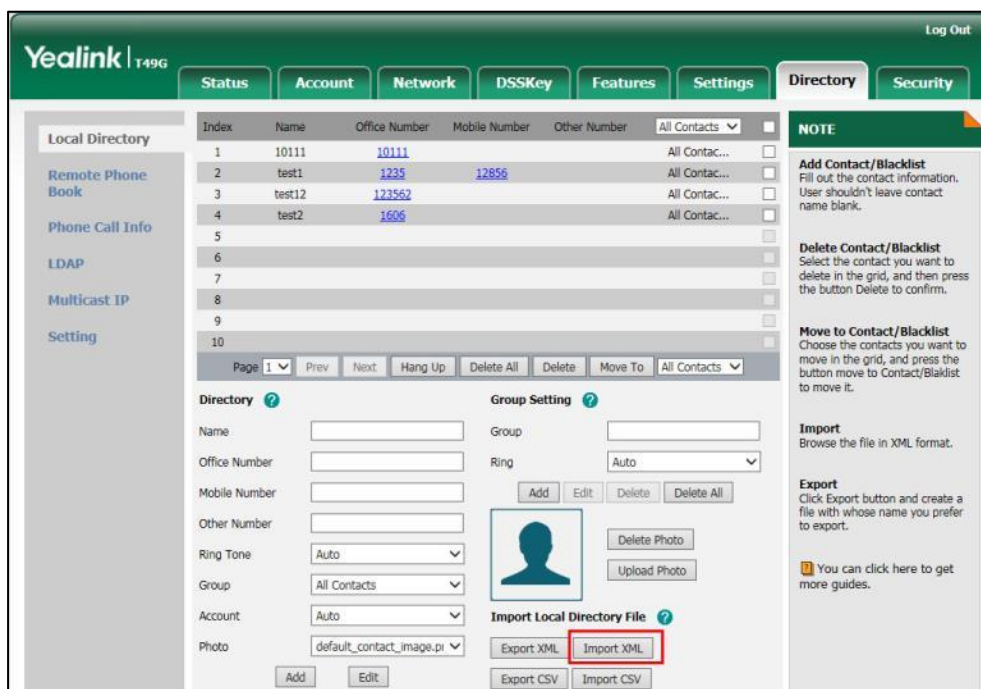

The web user interface prompts "The original contact will be covered, Continue?".

3. Click **OK** to complete importing the contact list.

To import a CSV contact list file via web user interface:

1. Click on **Directory->Local Directory**.

- Click **Import CSV** to locate and upload a contact list file (the file format must be *.csv) from your local system.

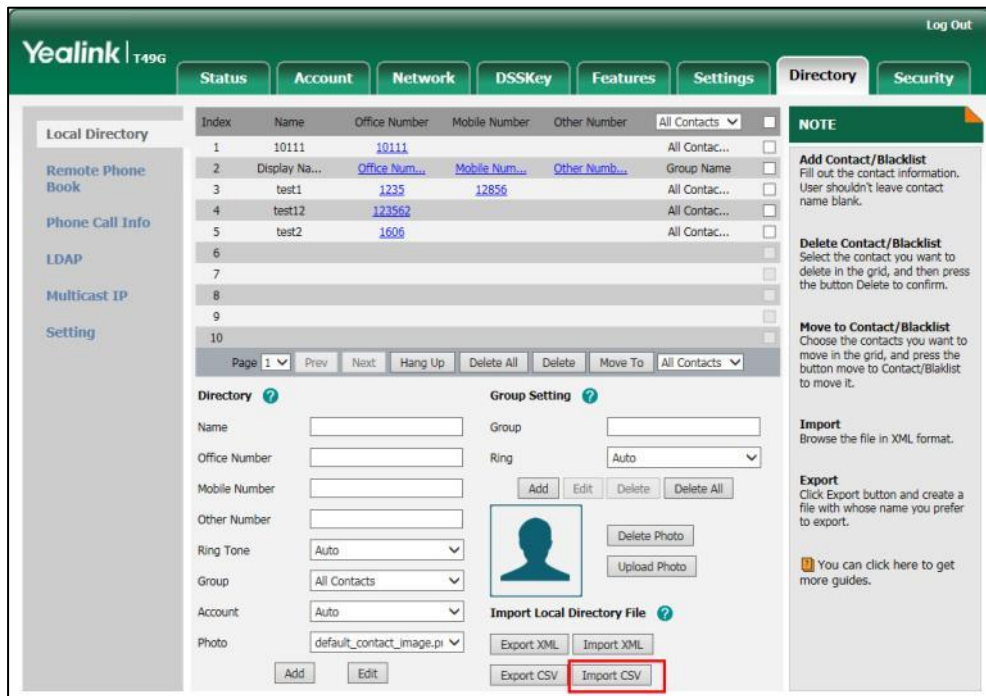

- (Optional.) Check the **Show Title** checkbox.
It will prevent importing the title of the contact information which is located in the first line of the CSV file.
- (Optional.) Check the **Delete Old Contacts** checkbox.
It will delete all existing contacts while importing the contact list.

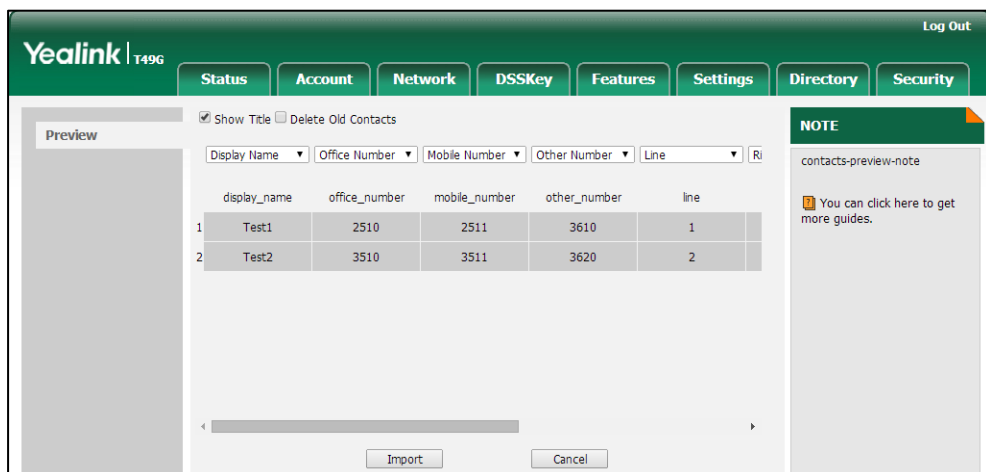

- Click **Import** to complete importing the contact list.

To export a contact list via web user interface:

- Click on **Directory->Local Directory**.

2. Click **Export XML** (or **Export CSV**).

The screenshot shows the Yealink T49G web interface. The top navigation bar includes 'Status', 'Account', 'Network', 'DSSKey', 'Features', 'Settings', 'Directory', and 'Security'. The 'Directory' tab is active. On the left, there is a sidebar with 'Local Directory', 'Remote Phone Book', 'Phone Call Info', 'LDAP', 'Multicast IP', and 'Setting'. The main content area displays a table of contacts with columns for Index, Name, Office Number, Mobile Number, Other Number, and All Contacts. Below the table are 'Directory' and 'Group Setting' forms. The 'Export XML' and 'Export CSV' buttons are highlighted with a red box. A 'NOTE' section on the right provides instructions for adding, deleting, and moving contacts, as well as importing and exporting files.

3. Click **Save** to save the contact list to your local system.

Note Importing/exporting contact lists is available via web user interface only.

Blacklist

The built-in phone directory can store names and phone numbers for a blacklist. You can store up to 30 contacts; add, edit, delete or search for a contact in the blacklist directory, and even call a contact from the blacklist directory. Incoming calls from the blacklist directory contacts will be rejected automatically.

To add a contact to the blacklist directory manually:

1. Tap  -> **Blacklist**.

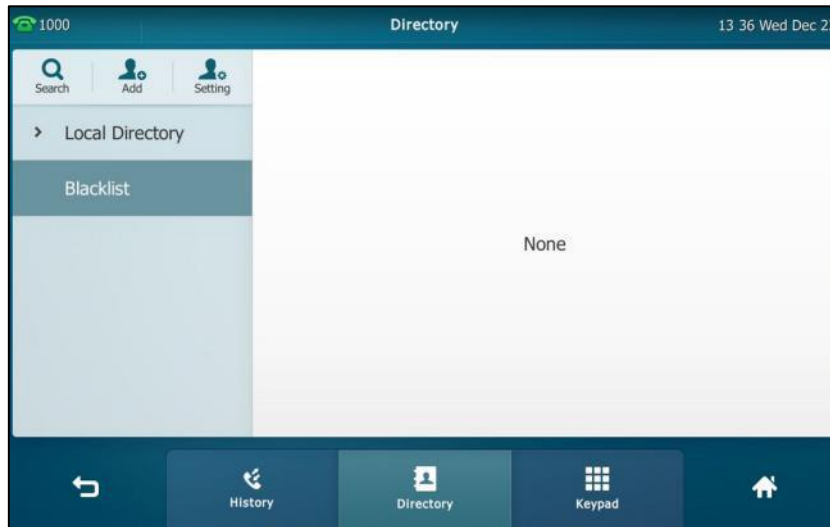

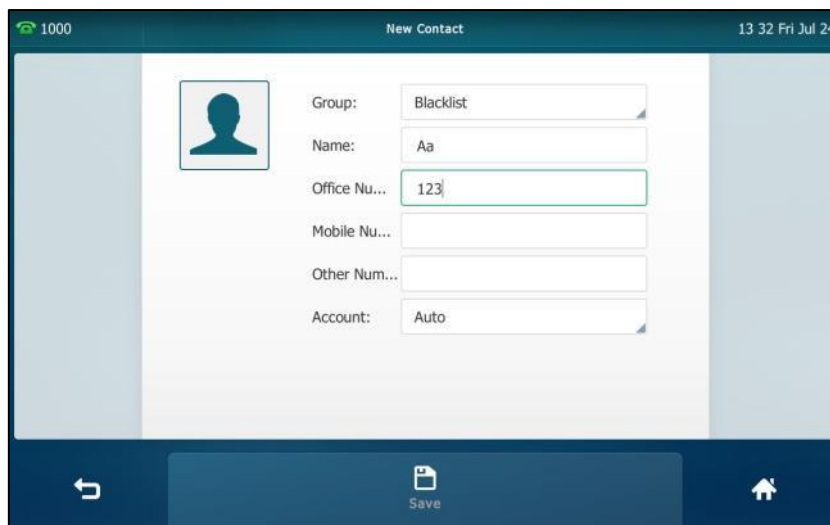

2. Tap **Add**.
3. Enter the contact's name and the office, mobile or other numbers in the corresponding fields.



4. Tap the **Account** field.
5. Tap the desired account in the pop-up dialog box.
If **Auto** is selected, the phone will use the default account when placing calls to the contact from the blacklist directory.
6. Tap the **Save** soft key to accept the change or  to cancel.

To add a contact to the blacklist directory from the local directory:

1. Tap .
2. Tap  after the desired contact.
If the contact was added to a specified contact group, you can tap the contact

group first, and then tap  after the desired contact.

3. Tap **Blacklist**.

The touch screen prompts the following warning:

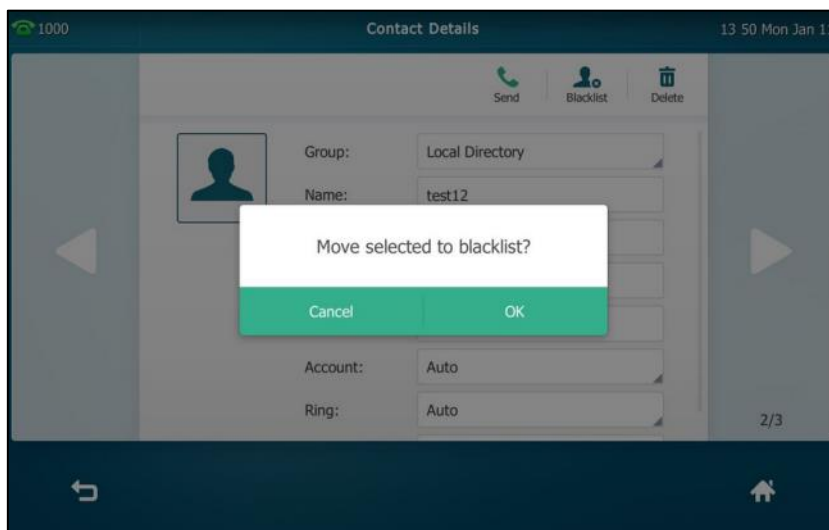

4. Tap **OK** to accept the change.

For operating instructions on editing, deleting, placing calls to and searching for contacts in the blacklist directory, refer to the operating instructions of [Local Directory](#) on page 82.

Remote Phone Book

You can add contacts to the local directory, search for a contact, or simply dial a contact number from the remote phone book.

You can configure your new phone to access up to 5 remote phone books. The phone supports up to 5000 remote phone book entries. For the access URL of the remote phone book, contact your system administrator.

For operating instructions on placing calls to and searching for contacts in the remote phone book, refer to the operating instructions of [Local Directory](#) on page 82.

Configuring an Access URL

To configure an access URL for a remote phone book via web user interface:

1. Click on **Directory->Remote Phone Book**.
2. Enter the access URL in the **Remote URL** field.

3. Enter the name in the **Display Name** field.

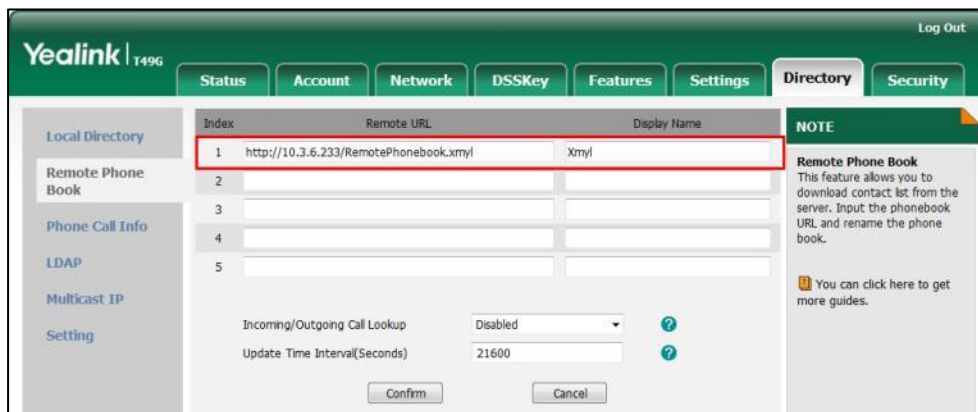

4. Click **Confirm** to accept the change.

Note An access URL for a remote phone book is configurable via web user interface only.

Accessing the Remote Phone Book

To access your remote phone book via phone user interface:

1. Tap -> **Remote Phone Book** or tap -> **Directory**-> **Remote Phone Book** to enter the remote phone book.
2. Tap the desired remote phone book.

The phone then connects to the remote phone book and proceeds to load it. The contacts in the remote phone book are displayed on the touch screen.

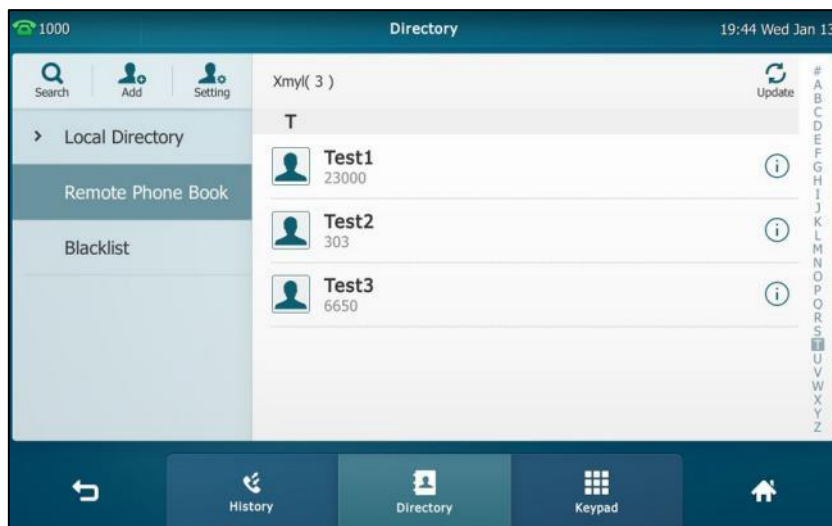

You can tap to back to the previous interface.

Incoming/Outgoing Call Lookup

You can enable the phone to present the caller/callee identity stored in the remote phone book when receiving/placing a call.

To configure incoming/outgoing call lookup and update time interval via web user interface:

1. Click on **Directory**->**Remote Phone Book**.
2. Select **Enabled** from the pull-down list of **Incoming/Outgoing Call Lookup**.
3. Enter the desired refresh period in the **Update Time Interval(Seconds)** field.
The default value is 21600.

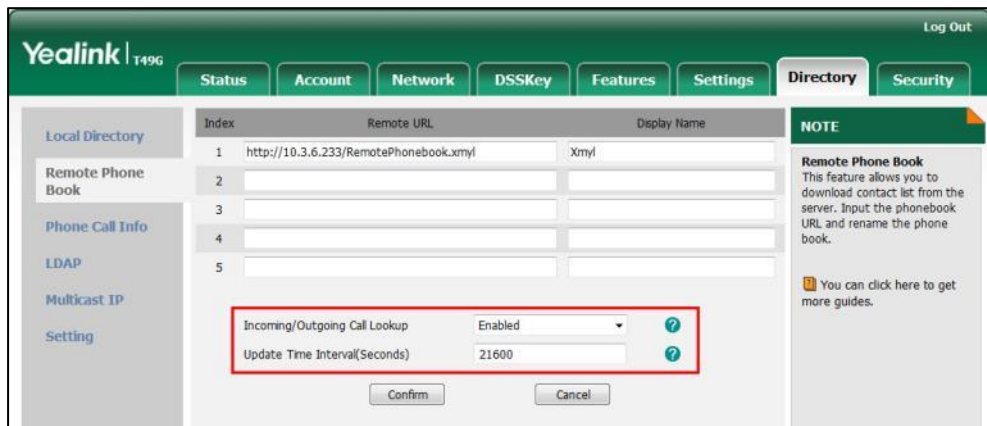

4. Click **Confirm** to accept the change.

Mobile Contacts

The first time your IP phone pairs and connects to your Bluetooth-enabled mobile phone, you will be asked if you would like to sync phone contacts temporarily. If allowed, the phone contacts will be imported to the mobile contacts directory of your IP phone. For more information, refer to [Bluetooth-Enabled Mobile Phone](#) on page 123.

You can add a contact to the local directory or blacklist directory from mobile contacts. You cannot add a contact to the mobile contacts directory on your IP phone.

Note If you disconnect the Bluetooth-enabled mobile phone from IP phone or disable the IP phone to sync phone contacts, the mobile contacts directory will disappear.

To add a contact to the local directory from mobile contacts directory:

1. Tap  ->**Mobile Contacts**.
2. Drag up and down to view the list of Mobile Contacts.

3. Tap  after the desired entry.

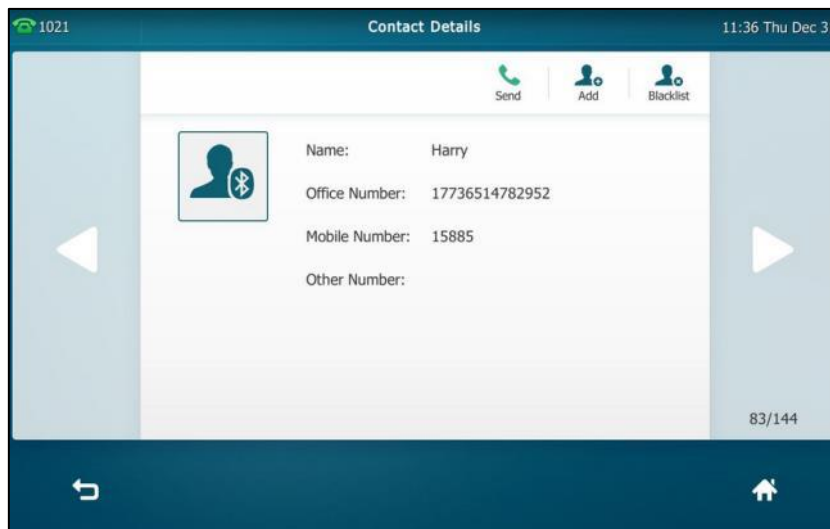

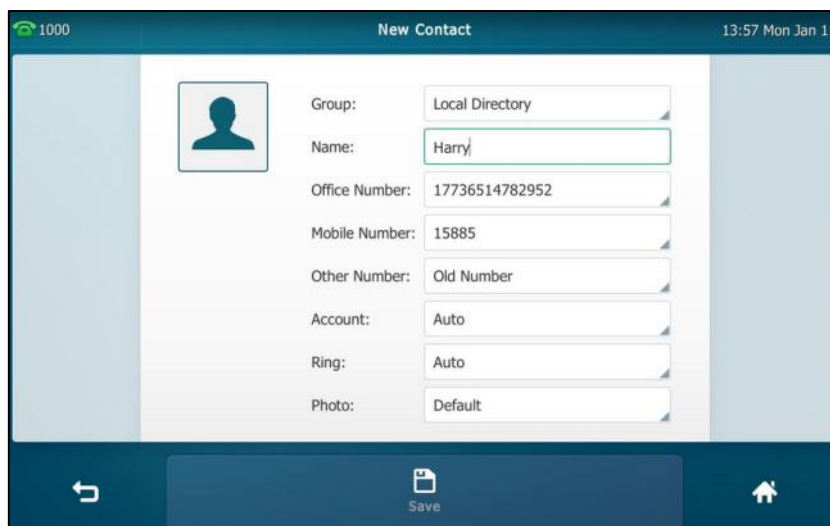

4. Tap **Add**.
5. Edit the corresponding fields.



6. Tap the **Save** soft key to accept the change.
The entry is successfully saved to the local directory.

To add a contact to the blacklist directory from the mobile contacts directory:

1. Tap  -> **Mobile Contacts**.
2. Tap  after the desired contact.
3. Tap **Blacklist**.

4. Edit the corresponding fields.

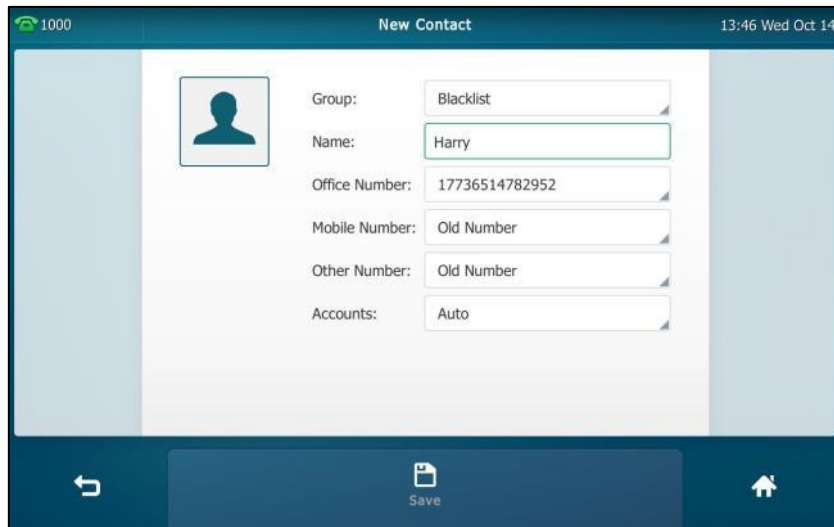

5. Tap the **Save** soft key to accept the change.

The entry is successfully saved to the blacklist directory.

For operating instructions on placing calls to and searching for contacts in the mobile contacts directory, refer to the operating instructions of [Local Directory](#) on page 82.

Note

The contact that be added to the local directory or blacklist directory will not disappear, after you disconnect the mobile phone from the IP phone.

To update the mobile contacts directory:

1. Tap -> **Mobile Contacts**.
2. Tap **Update**.

The touch screen will prompt “Updating, please wait...”, you need to authorize the IP phone to sync the contacts temporarily on the mobile phone.

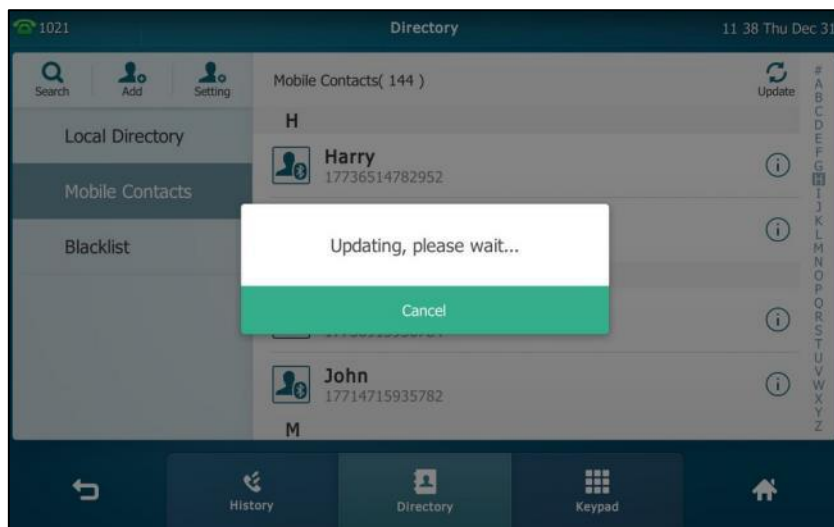

After updating, the contacts you add, edit, delete on the mobile phone will sync to

the mobile contacts directory.

Note

If you disconnect the mobile phone from IP phone while the IP phone is updating the mobile phone book. The touch screen will prompt "Fail to download mobile contacts!", and the mobile contacts directory will disappear from the IP phone directory list.

Call History Management

The SIP VP-T49G IP phone maintains call history lists of Missed calls, Placed calls, Received calls and Forwarded calls. Each call history list supports up to 100 entries. You can view call history, place a call, add a contact or delete an entry from the call history list.

History record feature is enabled by default, if you don't want to save the call history, you can disable the feature.

Viewing History Records

To view call history:

1. Tap .

The touch screen displays all call records.

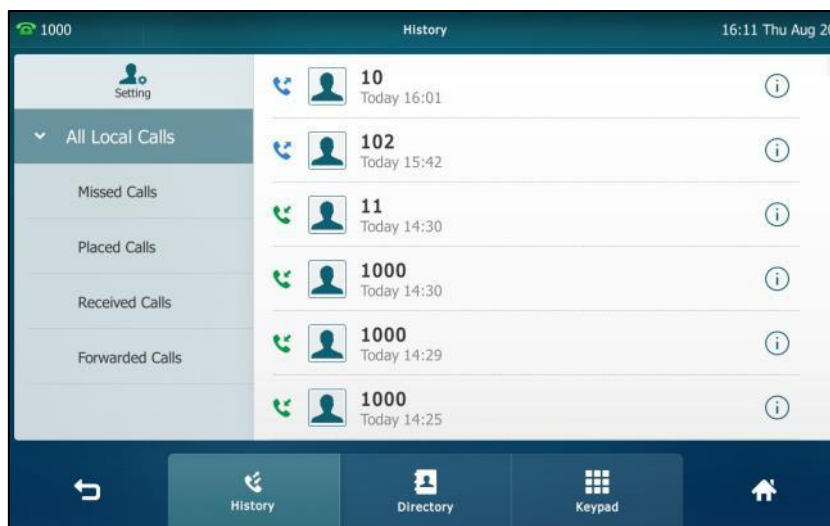

2. Drag up and down to scroll.

You can tap **Missed Calls**, **Placed Calls**, **Received Calls** or **Forwarded Calls** to view entries in each call list directly.

3. Tap  after the desired entry.

The detailed information of the entry appears on the touch screen.

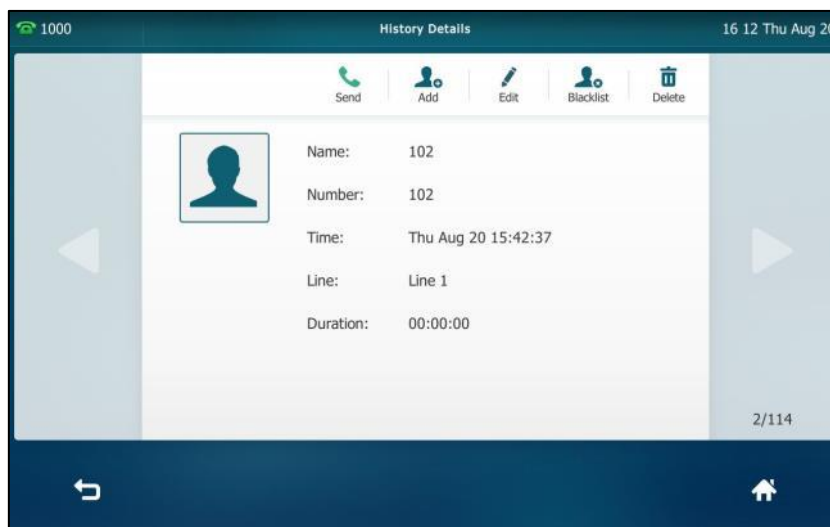

To place a call from the call history list:

1. Tap  .

The touch screen displays all call records.

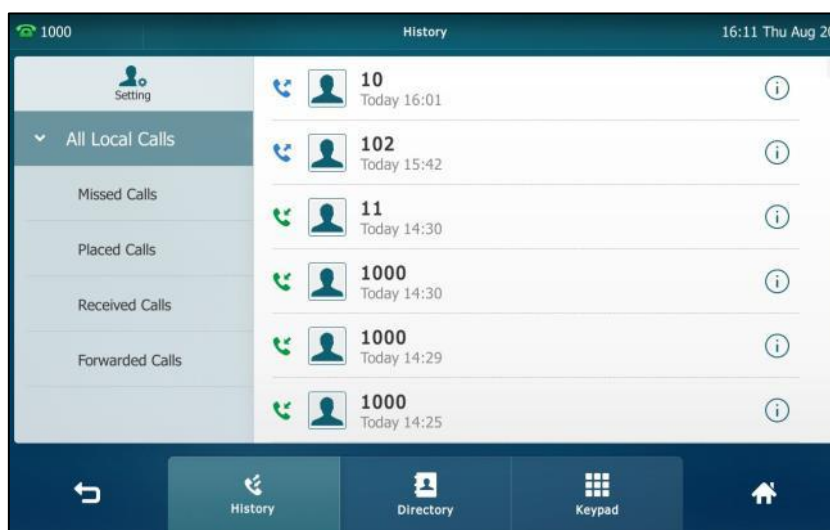

2. Drag up and down to scroll.

You can tap **Missed Calls**, **Placed Calls**, **Received Calls** or **Forwarded Calls** to view entries in each call list directly.

3. Tap the desired entry.

To add a contact to the blacklist directory from the call history list:

1. Tap  .

The touch screen displays all call records.

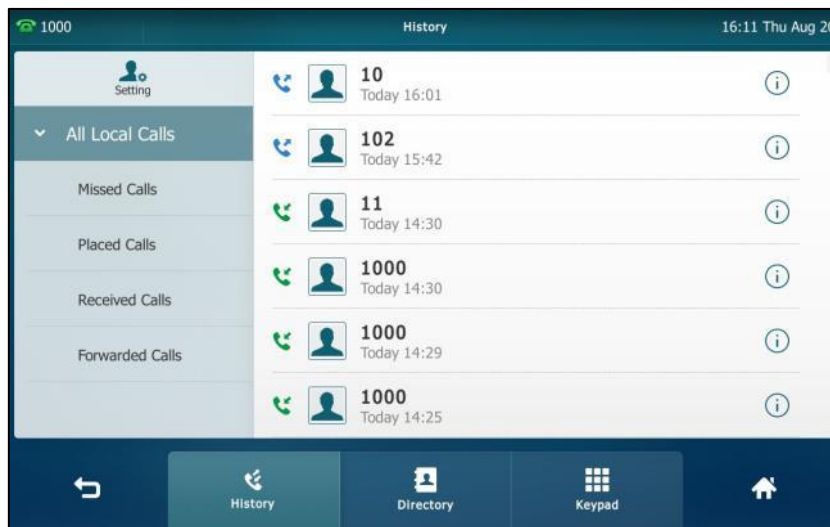

2. Drag up and down to scroll.

You can tap **Missed Calls**, **Placed Calls**, **Received Calls** or **Forwarded Calls** to view entries in each call list directly.

3. Tap  after the desired entry.
4. Tap **Blacklist**.



5. Enter the desired values in the corresponding fields.
6. Tap the **Save** soft key to accept the change or  to cancel.

For more information, refer to [Contact Management](#) on page 82.

Deleting History Records

To delete an entry from the call history list:

1. Tap .

The touch screen displays all call records.

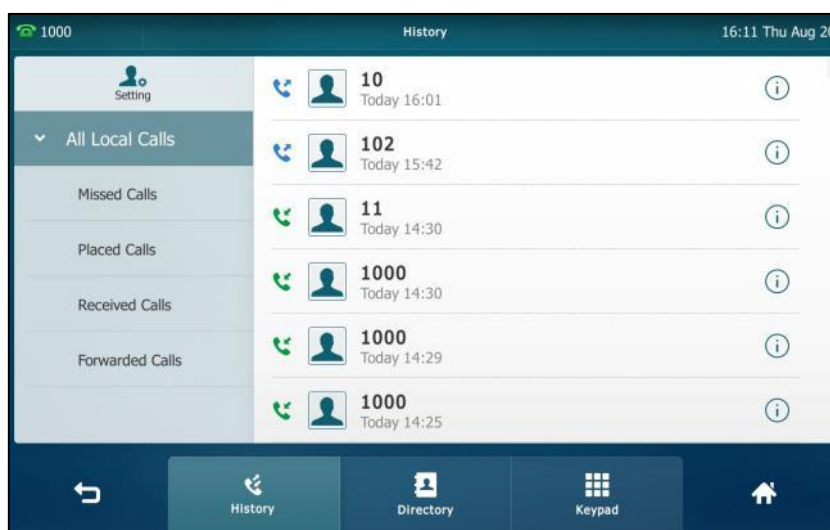

2. Drag up and down to scroll.

You can tap **Missed Calls**, **Placed Calls**, **Received Calls** or **Forwarded Calls** to view entries in each call list directly.

3. Tap  after the desired entry.
4. Tap **Delete**.

The touch screen prompts the following warning:

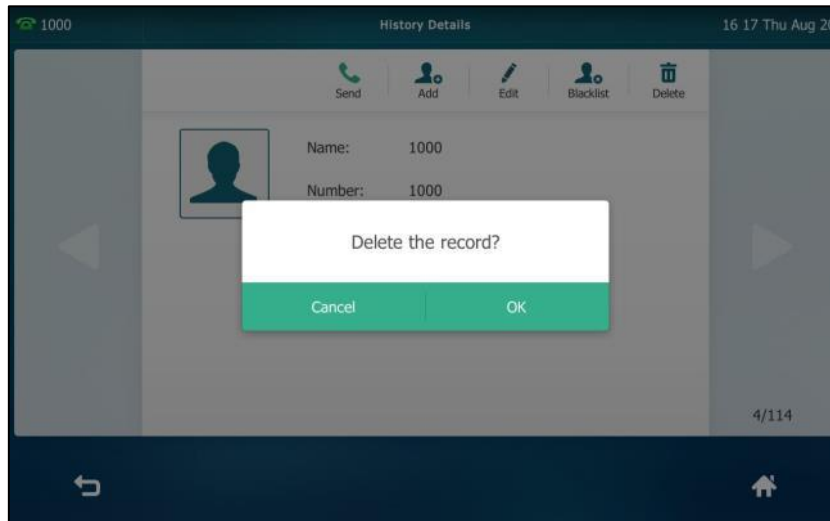

5. Tap **OK** to confirm the deletion or **Cancel** to cancel.

To delete all entries from the call history list:

1. Tap  .

The touch screen displays all call records.



2. Drag up and down to scroll.

You can tap **Missed Calls**, **Placed Calls**, **Received Calls** or **Forwarded Calls** to view entries in each call list directly.

3. Tap **Setting**.
4. Tap the **Select All** checkbox.

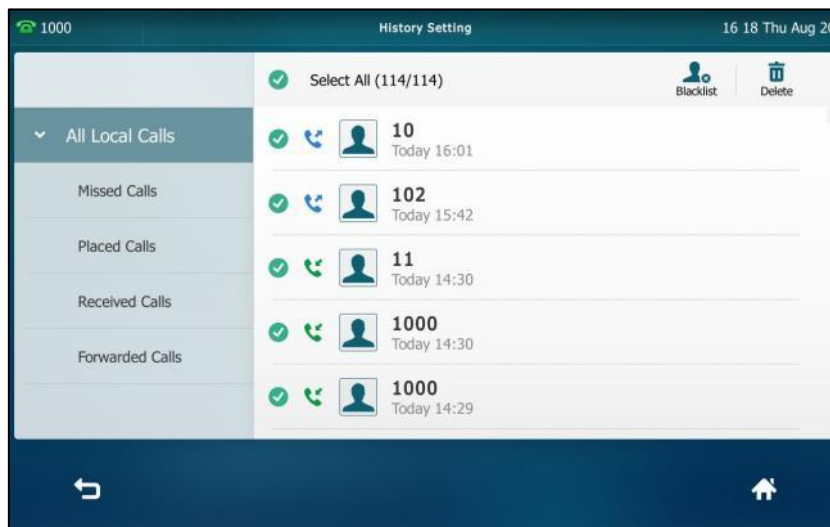

5. Tap **Delete**.

The touch screen prompts the following warning:

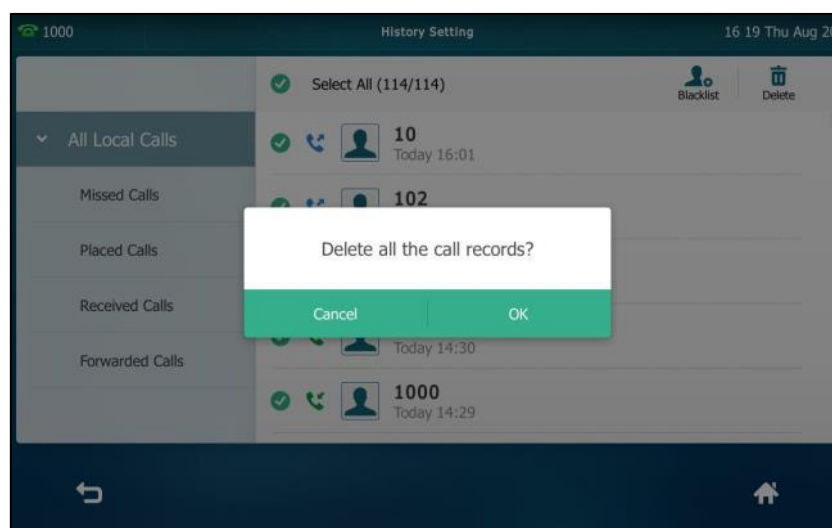

6. Tap **OK** to confirm the deletion or **Cancel** to cancel.

Disabling History Records

To disable history record via phone user interface:

1. Tap  -> **Features**->**General**.
2. Tap the **Off** radio box in the **History Record** field.

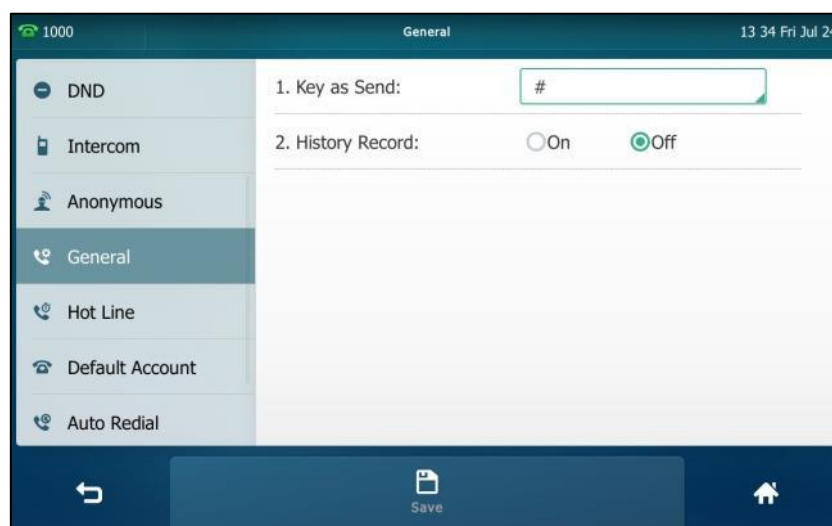

3. Tap the **Save** soft key to accept the change or  to cancel.

System Customizations

Headset Use

If you want to use a wired headset, physically connect your headset and activate the headset mode for use. For more information on physically connecting a headset, refer to [Phone Installation](#) on page 29.

If you want to use a wireless headset, activate the Bluetooth mode and then pair and connect the Bluetooth headset with your phone. For more information on using a Bluetooth headset, refer to [Bluetooth Headset](#) on page 117.

This section provides an introduction to wired headset use.

Note

There are three types of headsets for SIP VP-T49 IP phones: the wired headset, EHS headset and Bluetooth headset. You can connect up to three types of headsets at once. And if you press the **HEADSET** key, the IP phone will use the headset according to the priority: Bluetooth headset >EHS headset >wired headset.

Headset Mode Activation/Deactivation

To activate the headset mode:

1. Press  on the phone.

The HEADSET key LED illuminates solid green, and the icon  appears on the status bar of the touch screen when the headset mode is activated. When you tap the line key or the **Answer** soft key to answer an incoming call, the call is connected to your headset automatically. For more information on using the headset to answer a call, refer to [Answering Calls](#) on page 158.

With the handset on-hook, enter the desired number and tap the **Send** soft key, the phone will then place a call using the headset automatically. For more information on using the headset to place a call, refer to [Placing Calls](#) on page 156.

To deactivate the headset mode:

1. Press  again on the phone.

The HEADSET key LED goes out, and the icon  disappears from the touch screen when the headset mode is deactivated.

Headset Prior

You can use headset in priority when headset prior feature is enabled. This feature is especially useful for permanent or full-time headset users.

To enable headset prior via web user interface:

1. Click on **Features->General Information**.
2. Select **Enabled** from the pull-down list of **Headset Prior**.

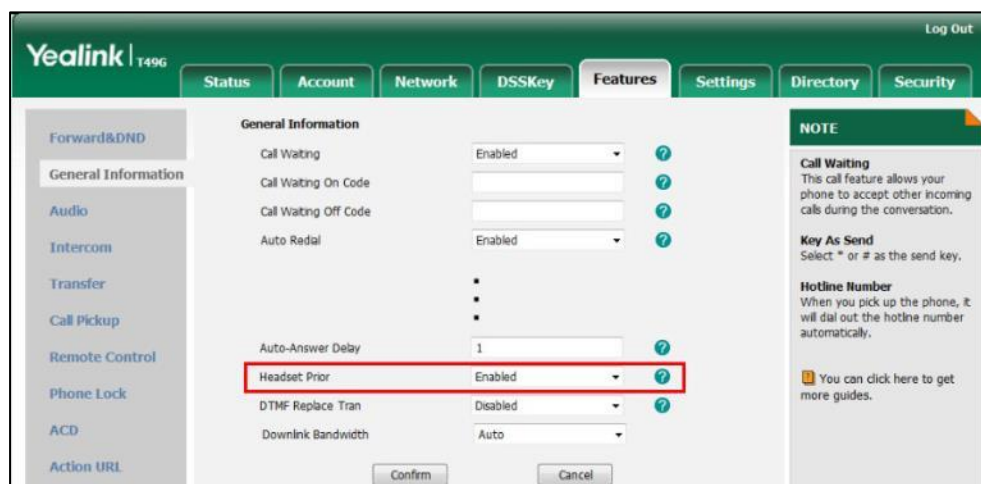

3. Click **Confirm** to accept the change.

To use headset prior, you should activate the headset mode in advance:

1. Physically connect the headset.
2. Press  to activate the headset mode.

Note

If headset prior is enabled, the headset mode will not be deactivated until you press the **HEADSET** key again.

If headset prior is disabled, the headset mode can be deactivated by pressing the Speakerphone key or the **HEADSET** key.

Headset prior is configurable via web user interface only.

Dual Headset

You can use two headsets when dual headset feature is enabled. To use this feature, you must physically connect headsets to the headset jack and handset jack respectively. Once the phone connects to a call, the headset connected to the headset jack will have full-duplex capabilities, while the one connected to the handset jack will only be able to listen.

To enable dual headset via web user interface:

1. Click on **Features->General Information**.

2. Select **Enabled** from the pull-down list of **Dual-Headset**.

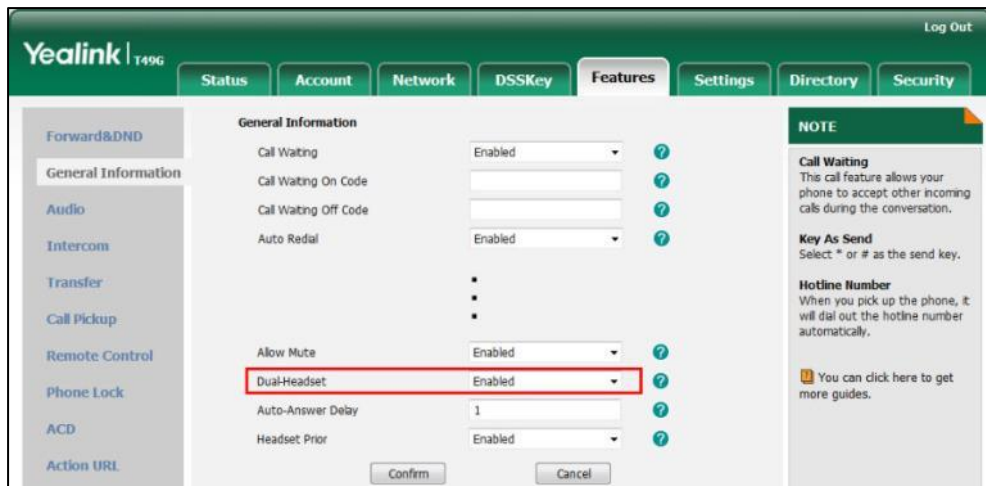

3. Click **Confirm** to accept the change.

Note Dual headset is configurable via web user interface only.

Bluetooth Headset

The SIP VP-T49G IP phone supports Bluetooth. Bluetooth enables low-bandwidth wireless connections within a range of 10 meters (32 feet). The best performance is in the 1 to 2 meter (3 to 6 feet) range.

You can activate/deactivate the Bluetooth mode, and then pair and connect the Bluetooth headset with your phone. You can pair up to countless Bluetooth headsets with your phone; however, only one headset can be connected at a time. You can also disconnect and delete your Bluetooth headset from the phone.

Activating the Bluetooth Mode

To activate the Bluetooth mode via phone user interface:

1. Tap  -> **Basic**-> **Bluetooth**.
2. Tap the **On** radio box in the **Bluetooth** field.

The IP phone scans the available Bluetooth headset automatically.

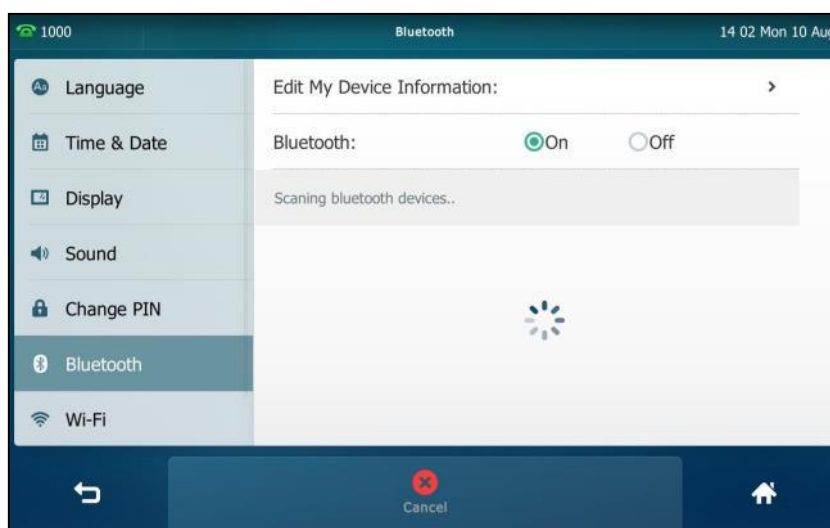

The touch screen displays the Bluetooth device information (device name and MAC address).

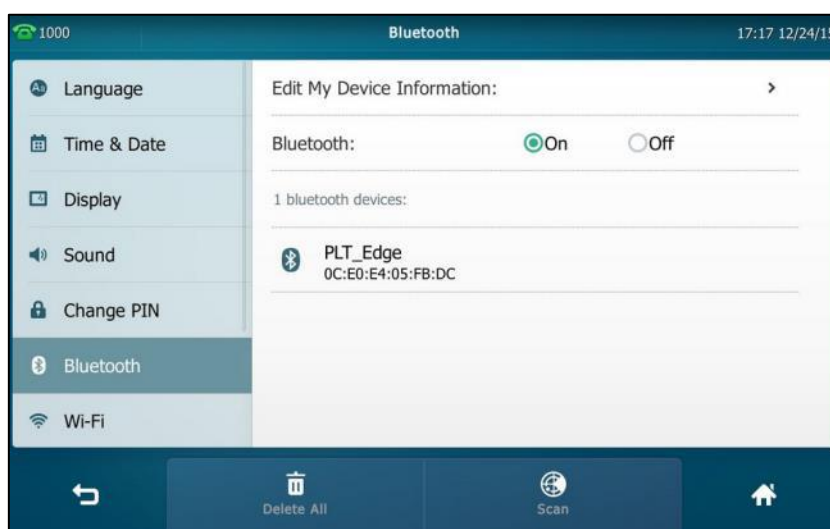

You can also swipe down from the top of the screen to enter the control center, and toggle **Bluetooth** on.

Pairing and Connecting the Bluetooth Headset

Before you pair a Bluetooth headset, check the indicator on the Bluetooth headset to make sure that the Bluetooth headset is discoverable. For more information, refer to the documentation from the Bluetooth headset manufacturer.

To pair and connect your Bluetooth headset to your phone:

1. Tap  -> **Basic**->**Bluetooth**.
2. Tap the **On** radio box in the **Bluetooth** field.

If there is no Bluetooth devices found on the touch screen, tap the **Scan** soft key to search for the Bluetooth device.

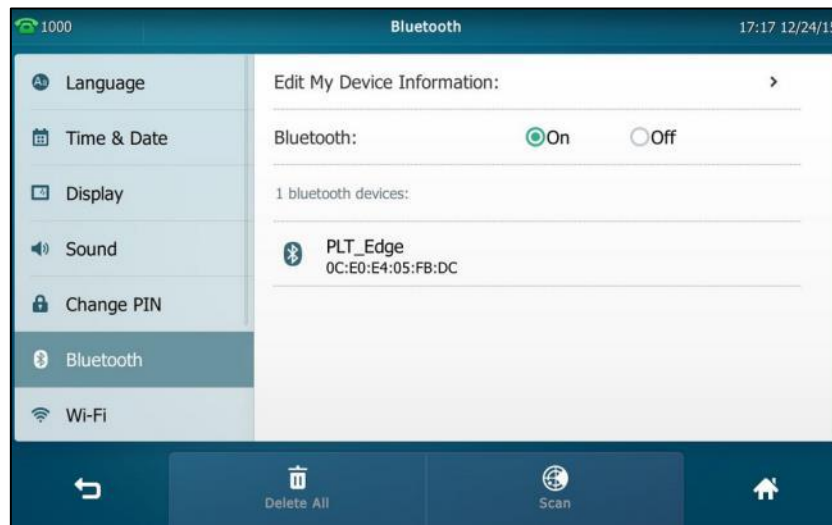

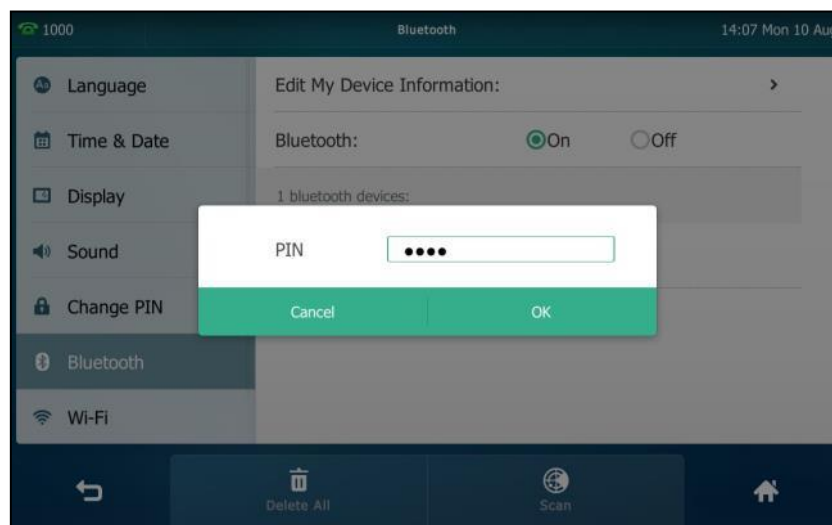

3. Tap the found Bluetooth device to connect the Bluetooth headset to your phone.
4. Enter the PIN in the prompted **PIN** field.
The default PIN is "0000".

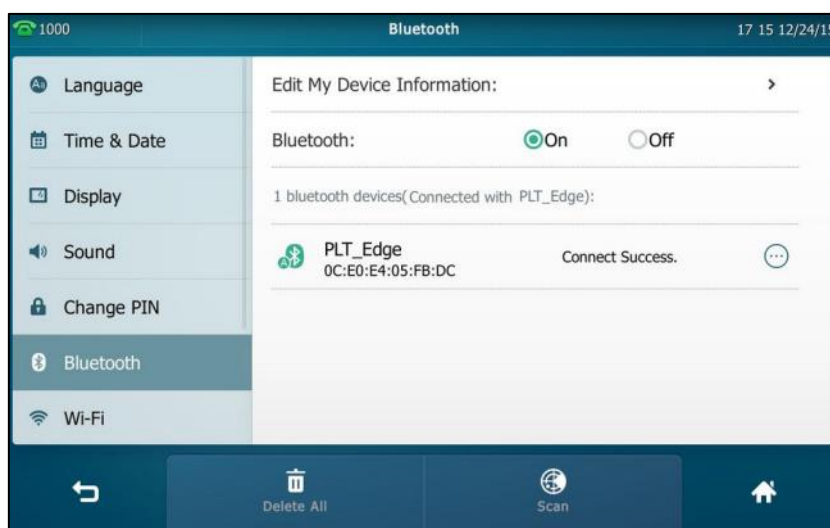

5. Tap **OK**.

The touch screen displays “Connect Success.”.



The Bluetooth icon  appears on the status bar of the touch screen.

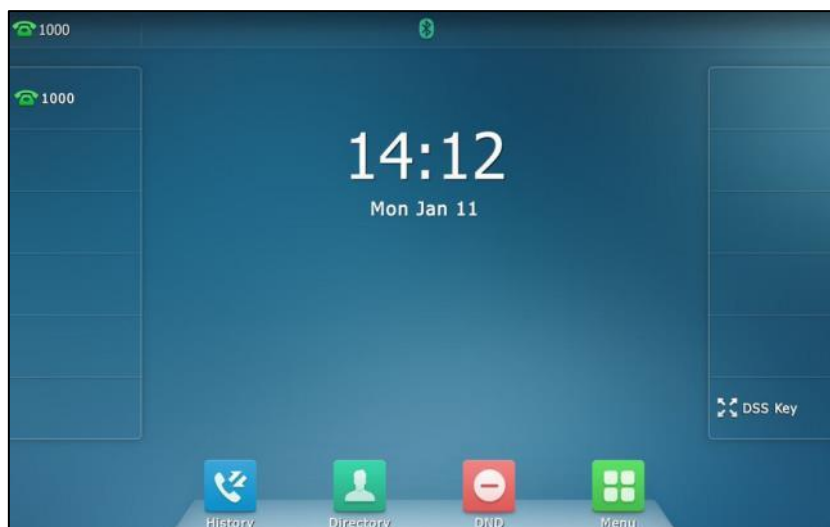

With the Bluetooth headset paired and connected, you can use the Bluetooth headset to place and answer calls. For more information, refer to the documentation from the Bluetooth headset manufacturer.

Editing Device Information

To edit device information via phone user interface:

1. Tap  ->Basic->Bluetooth->Edit My Device Information.

The touch screen displays the device name and MAC address. The MAC address cannot be edited.

2. Enter the desired name in the **Device Name** field.

The default device name is SIP VP-T49G.



3. Tap the **Save** soft key to accept the change or  to cancel.

The pre-configured Bluetooth device name will display in scanning list of other device.

Disconnecting the Bluetooth Headset

To disconnect your Bluetooth headset from your phone:

1. Tap  -> **Basic**-> **Bluetooth**.
2. Tap the connected Bluetooth headset.

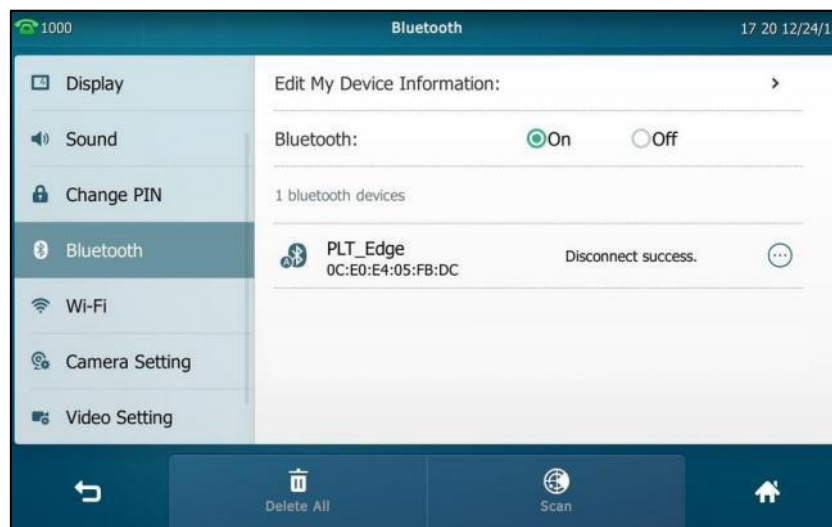

The Bluetooth headset is disconnected. To connect it to your phone again, tap the Bluetooth headset again.

Deleting the Paired Bluetooth Headset

You can delete your Bluetooth headset from your phone. When you delete the Bluetooth headset, it disappears from the **bluetooth devices** list. To connect it to your phone again,

you need to scan it first, and then connect it again.

To delete paired Bluetooth headset via phone user interface:

1. Tap  -> **Basic**->**Bluetooth**.

The touch screen displays the paired and connected Bluetooth headset.

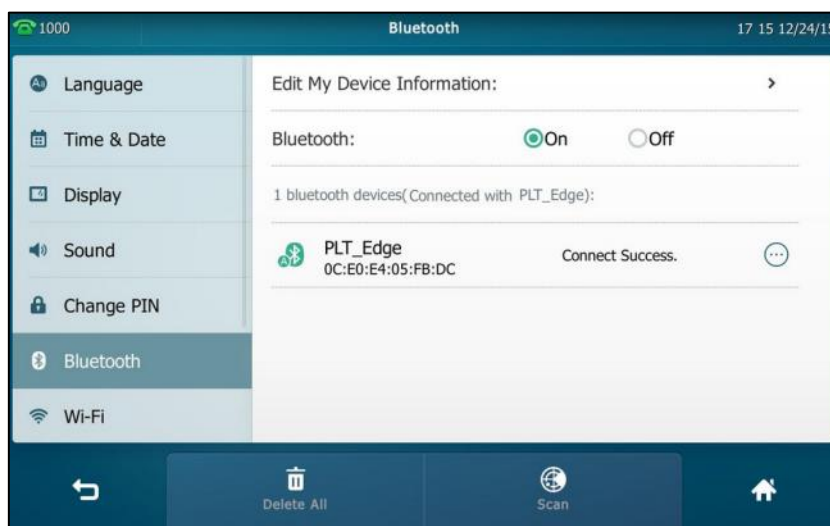

2. Tap  after the desired Bluetooth headset name.

3. Tap **Delete** in the pop-up dialog box.

The touch screen prompts the following warning “Delete selected item?”.

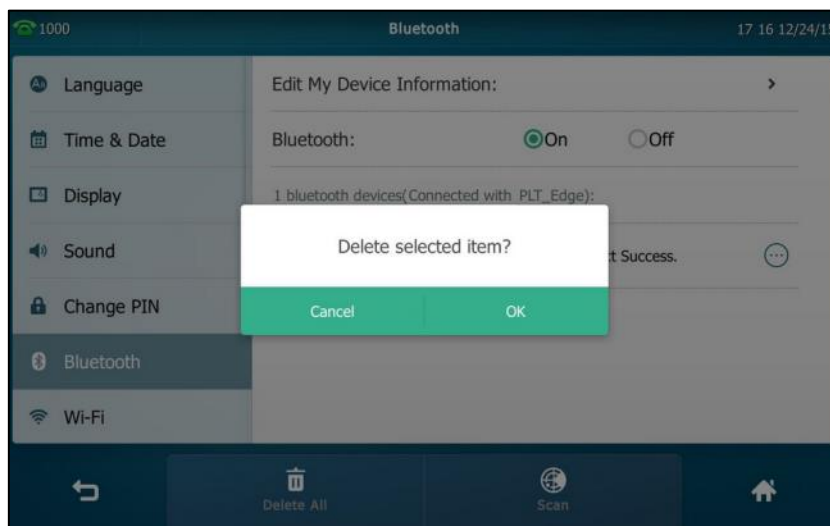

4. Tap **OK** to confirm the deletion or **Cancel** to cancel.

You can also delete all headsets by tapping the **Delete All** soft key.

Note

The icon  only appears after the device name of the Bluetooth device that you are connecting or have connected.

If you cannot connect a Bluetooth headset to the phone successfully, we recommend that you delete the Bluetooth headset in the **bluetooth devices** list (if it exists) before pairing it.

Deactivating the Bluetooth Mode

To deactivate the Bluetooth mode via phone user interface:

1. Tap  -> **Basic**->**Bluetooth**.
2. Tap the **Off** radio box in the **Bluetooth** field.

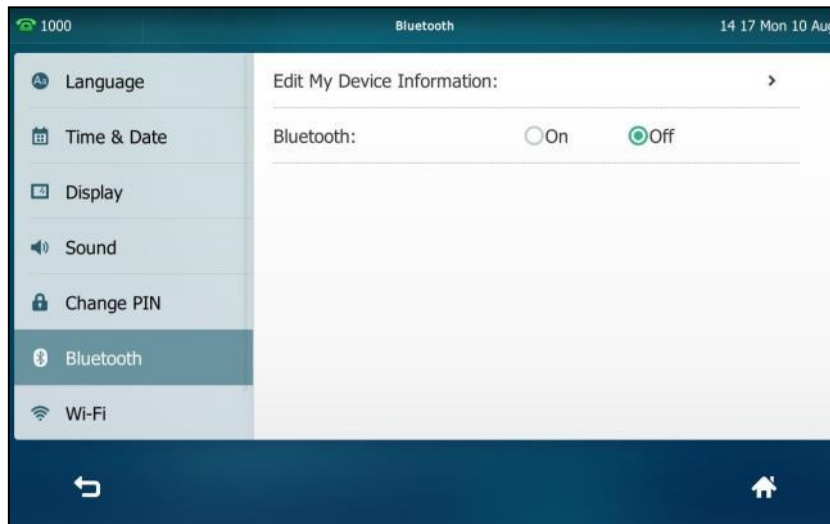

The Bluetooth icon  disappears from the touch screen.

Bluetooth mode is configurable via web user interface at the path **Features**->**Bluetooth**.

Bluetooth-Enabled Mobile Phone

Yealink SIP VP-T49G IP phone supports the use of your IP phone in conjunction with Bluetooth-enabled mobile phone. You can do the following:

- Pair and connect your IP phone with a Bluetooth-enabled mobile phone to make and receive mobile calls. Your mobile phone is automatically assigned a line key on your IP phone.
- Import your mobile contacts into the IP phone.
- Use your IP phone as a hands free device for your mobile phone.

For operating instructions on activating/deactivating the Bluetooth mode, editing device information and disconnecting/deleting the paired Bluetooth-enabled mobile phone, refer to the operating instructions of [Bluetooth Headset](#) on page 117.

Note

Not all mobile phones support this function. Contact your system administrator for more information.

Pairing and Connecting the Bluetooth-Enabled Mobile Phone

You can only connect one Bluetooth device at a time. After connection, the IP phone will

automatically find an available line key and assign the line key for Mobile Line. The Mobile Line key's default label is "My Mobile". If there is no available line key, you may assign it manually.

The mobile phone will disconnect from your phone in the following introduced scenarios:

- Deactivate the Bluetooth mode from the IP phone.
- Connect a Bluetooth headset to the IP phone.
- Deactivate the Bluetooth mode from mobile phone.
- The distance between mobile phone and IP phone is out of the range of 10 meters.

Before you pair a Bluetooth-Enabled mobile phone, check the Bluetooth mode on the Bluetooth-Enabled mobile phone to make sure that the Bluetooth-Enabled mobile phone is discoverable.

To pair and connect the Bluetooth-Enabled Mobile Phone with your phone:

1. Tap  -> **Basic**->**Bluetooth**.
2. Tap the **On** radio box in the **Bluetooth** field.

If there is no Bluetooth-Enabled mobile phone found on the touch screen, tap the **Scan** soft key to search for the Bluetooth-Enabled mobile phone.

3. Tap the desired Bluetooth-Enabled mobile phone in the Bluetooth devices list to connect the mobile phone to your phone.

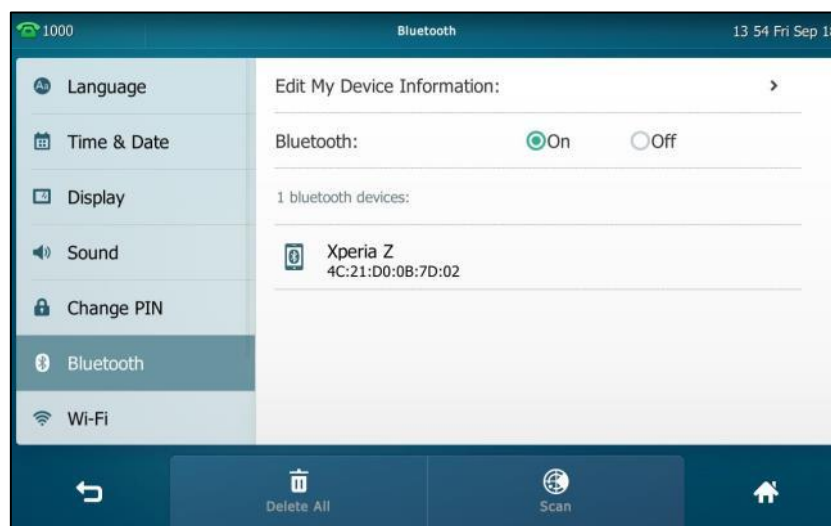

4. Tap **OK** on both mobile phone and IP phone.

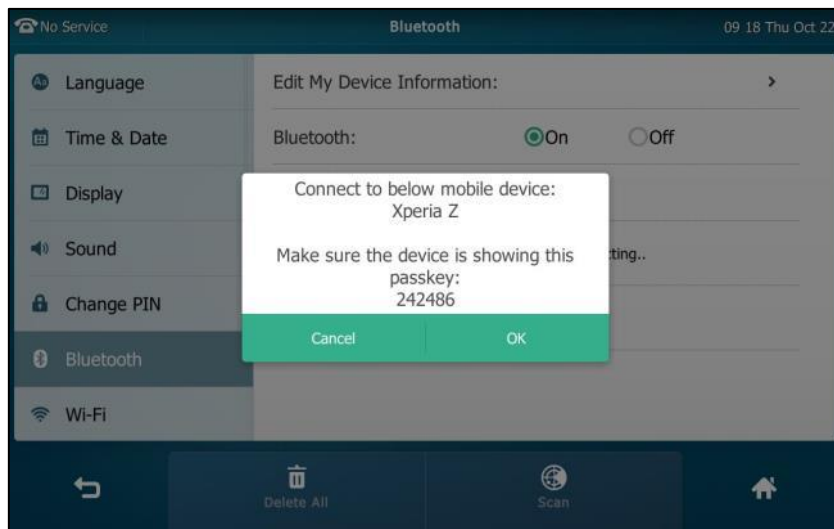

Then the IP phone will prompt “Would you like to sync phone contacts temporarily?”.

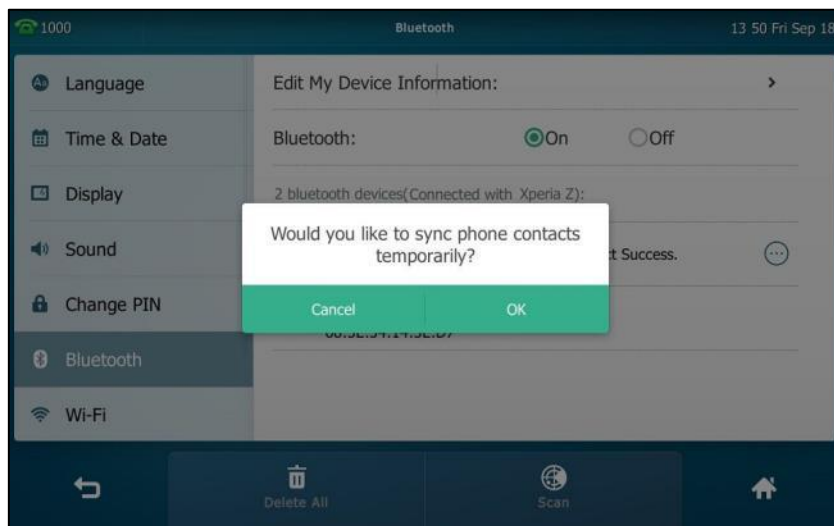

5. (Optional.) Tap **OK** to enable the mobile contacts sync feature and the IP phone will sync the mobile contacts temporarily, or tap **Cancel** to disable mobile contacts sync feature and the IP phone will not sync the mobile contacts. If you tap **Cancel**, you can also manually enable the mobile contacts sync feature on the IP phone. For more information, refer to [Syncing the Mobile Contacts to the IP Phone](#) on page 127.

If you enable mobile contacts sync feature, you also need to authorize the IP phone to sync the contacts temporarily on the mobile phone.

The touch screen displays “Connect Success.”.

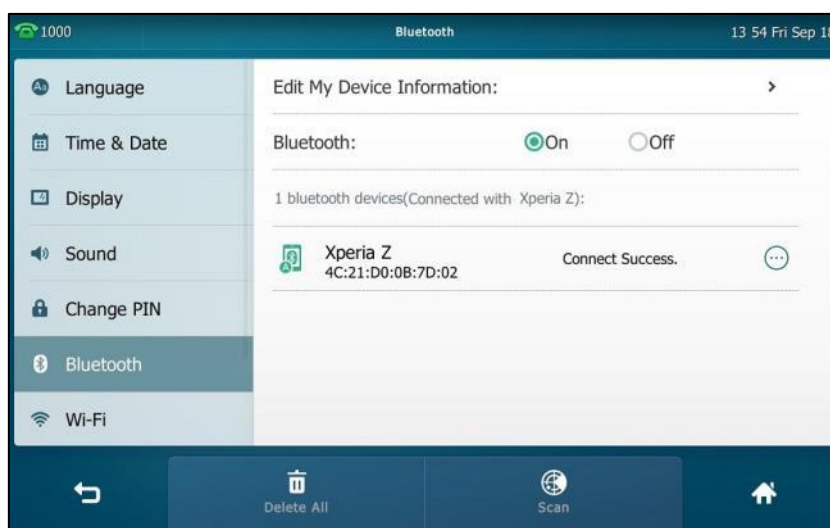

The Bluetooth icon  will display on the status bar of the touch screen. And the IP phone automatically assigns a Mobile Line key.

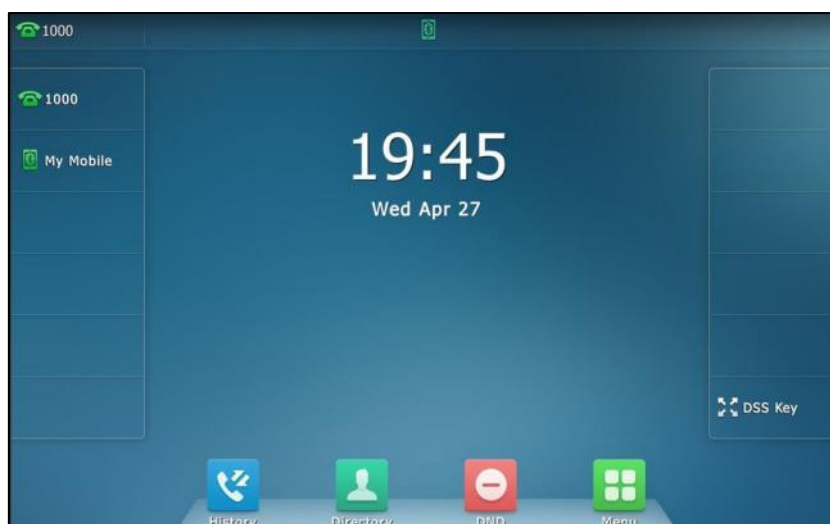

For more information on how to configure the Mobile Line key, refer to [Mobile Line](#) on page 140. Before you configure the Mobile Line key, make sure the Bluetooth-Enabled mobile phone is connected. Otherwise the IP phone will prompt “Mobile Account is not connected!”. If the distance between mobile phone and IP phone is out of the range of 10 meters or the Bluetooth mode on the mobile phone is deactivated, you can tap the Mobile Line key to reconnect the last paired Bluetooth-Enabled mobile phone.



Syncing the Mobile Contacts to the IP Phone

If you disable the mobile contacts sync feature when you pair and connect the Bluetooth-Enabled mobile phone to the IP phone (refer to [Pairing and Connecting the Bluetooth-Enabled Mobile Phone](#)), you need to enable the mobile contacts sync feature manually when you want to sync the mobile contacts the IP phone.

Note

Not all mobile phones support syncing the mobile contacts to IP phone. For more information, contact your system administrator.

To enable the mobile contacts sync feature manually:

1. Tap  -> **Basic**->**Bluetooth**.
2. Tap  after the desired Bluetooth-Enabled mobile phone name.
3. Tap the **On** radio box in the **Mobile Contacts Sync** field.

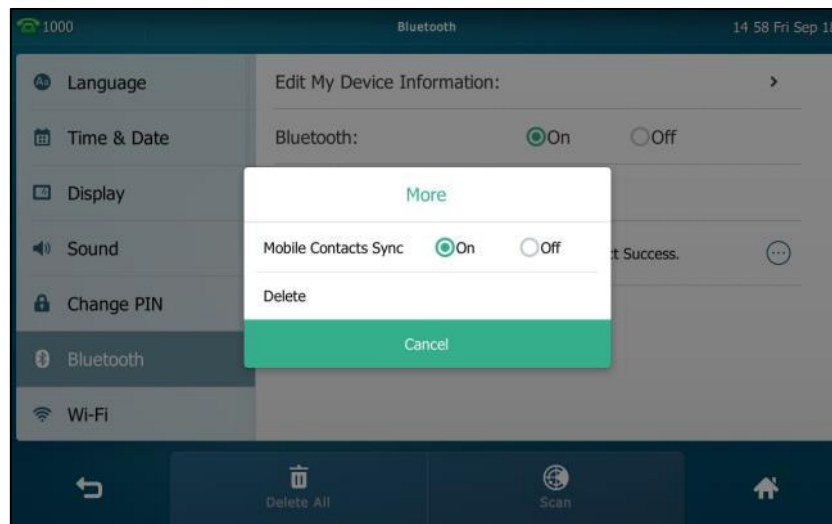

You need to authorize the IP phone to sync the contacts temporarily on the mobile phone.

And then the mobile contacts directory will appear in the IP phone directory list.

To view your mobile contacts on the IP phone:

1. Tap  -> **Mobile Contacts**.

The contacts in the mobile phone will display in the **Mobile Contacts** list.

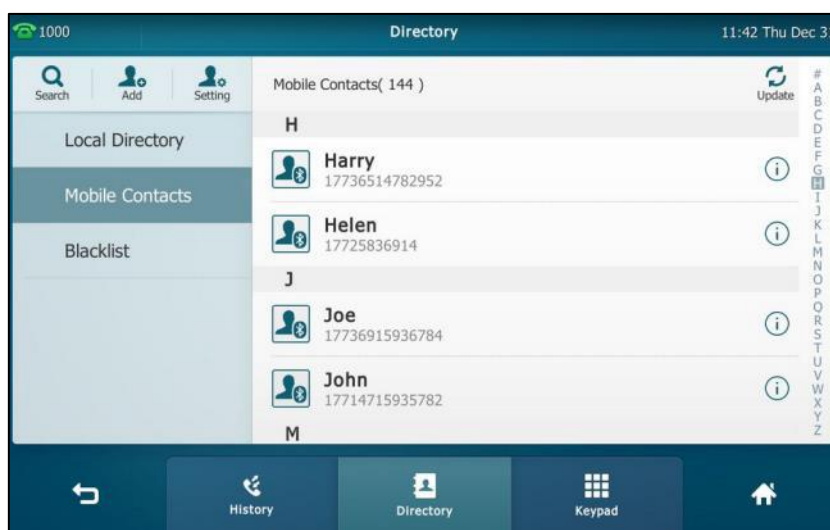

For operating instructions on adding contact to local/blacklist directory from mobile contacts directory, update the mobile contacts directory or placing calls to and searching for contacts in the mobile contacts directory, refer to the operating instructions of [Mobile Contacts](#) on page 106.

Note If the mobile phone disconnects from the IP phone while the IP phone is loading the mobile contacts, the touch screen will prompt “Fail to download mobile contacts!”, and the mobile contacts directory will not appear at the IP phone directory list.

Making a Mobile Phone Call by Using the IP Phone

When you make a mobile phone call by using your IP phone, the IP phone acts as a hands free device for your mobile phone. The call is made through your mobile phone, but the audio is present on and the call control is done by using the IP phone. You can have both mobile phone call and IP phone call on your IP phone, and two types of calls will not affect each other.

To make a call through a mobile phone:

1. Tap the **My Mobile** line key.



2. Enter the desired number using the keypad or the dial pad.
3. Tap **Call from Mobile**.

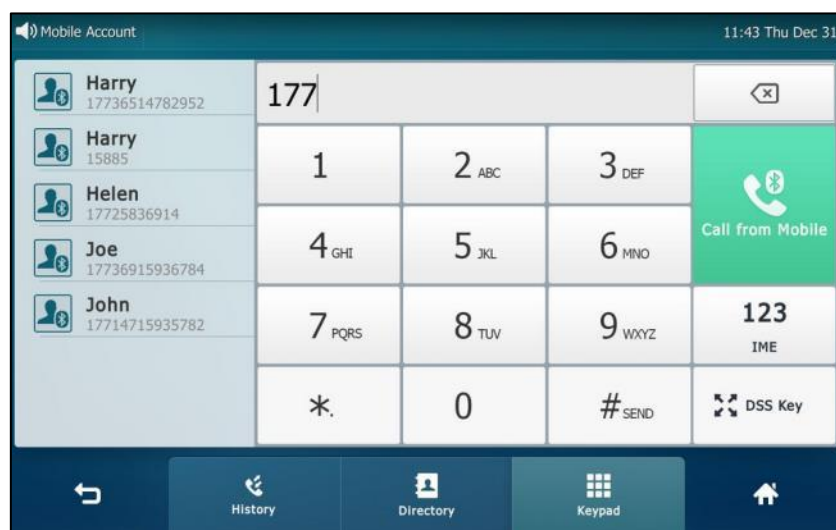

The outgoing call information will appear on both your IP phone and mobile phone screen. After the call is picked up, the audio goes through the IP phone, although the mobile phone screen also shows a connected call. You can hold, mute or end the call on the IP phone, and after you hold the call you can resume the call or place a new call.

Note

You can control the call's audio to go through the mobile phone or IP phone on your mobile phone. For example, if you choose Bluetooth, the audio will go through the IP phone; if you choose Handset earpiece or Speaker, the audio will go through the mobile phone.

The phone will first match the contacts in the mobile contacts directory to present the caller/callee identity when receiving/placing a mobile phone call.

Receiving Mobile Phone Calls by Using the IP Phone

If your mobile phone is paired and connected with the IP phone, an incoming call to your mobile phone is also shown on the IP phone.

To handle a mobile phone call by using the IP phone, do one of the following:

- Press , tap the **Answer** soft key or pick up the handset to connect to the call.
- Tap the **Reject** soft key to reject the call.

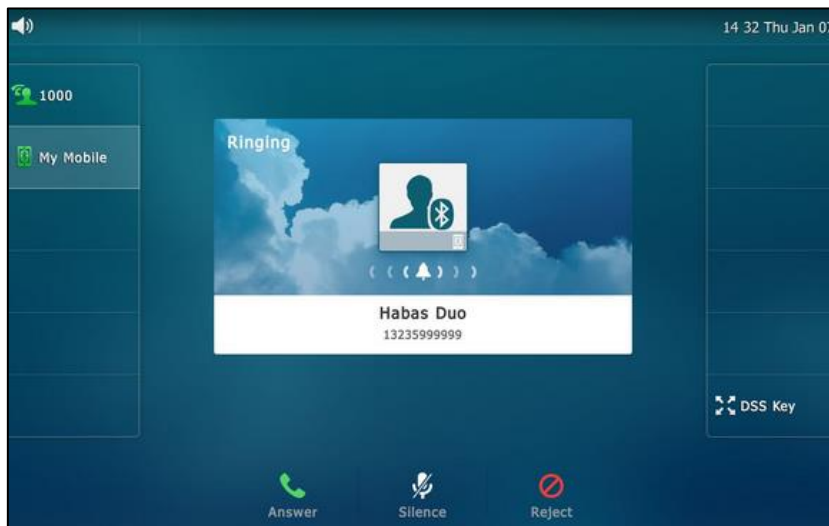

DSS Keys

There are two types of DSS keys: Line Keys and Programable Keys. Details will be introduced in the following. The SIP VP-T49G IP phone supports 29 line keys and 7 programable keys.

Line Keys

You can assign predefined functionalities to line keys. You can also define a label for a line key feature which will appear on the touch screen. Line keys allow you to quickly access features such as recall and voice mail. The line key can indicate the monitored status when the line keys are assigned with particular features, such as BLF. The default key type of line key 1-16 is Line. The default key type of line key 17-29 is N/A, which indicates that this line key provides no functionality until configuration.

You can also tap and hold the line keys on the idle screen to enter the line key configuration screen directly.

To assign functionality to a line key via phone user interface:

1. Tap  -> **Features**->**DSS Keys**.
2. Tap the desired line key.

3. Select the desired key type from the **Type** field.
4. (Optional.) Select the desired key event type from the **Key Type** field.
5. (Optional.) Select the desired line from the **Account ID** field.
6. (Optional.) Enter the string that will appear on the touch screen in the **Label** field.
7. (Optional.) Enter the corresponding value in the **Value** field.
8. (Optional.) Enter the corresponding value in the **Extension** field.

This option is only applicable to BLF feature. For more information, refer to [Busy Lamp Field \(BLF\)](#) on page 223.

9. Tap the **Save** soft key to accept the change or ↶ to cancel.

You can also tap **DSS Key** on the idle screen to enter the line key configuration screen directly.

Label Length

You can specify labels for some key features, which will be displayed on the idle touch screen. If the length of the label exceeds the maximum display length, the phone only displays the first few characters. You can configure the phone to display more characters via label length feature.

The following figure shows an example of label display when the label length feature is set to Extended:



The following figure shows an example of label display when the label length feature is set to Default:



To configure the label length via web user interface:

1. Click on **DSSKey->Line Key**.
2. Select **Extended** from the pull-down list of **Label Length**.

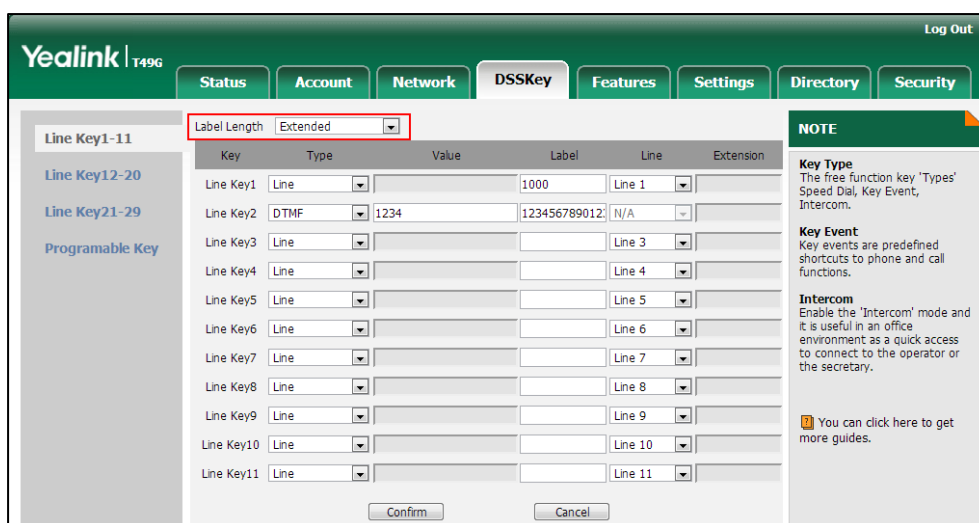

3. Click **Confirm** to accept the change.

Note

Label length feature is configurable via web user interface only.

Line key features are explained in the following subchapters in detail:

- Line
- Speed Dial
- Voice Mail
- Direct Pickup

- Group Pickup
- DTMF
- Prefix
- Local Group
- XML Group
- XML Browser
- LDAP
- SMS
- Conference
- Forward
- Transfer
- Hold
- DND
- Group Listening
- Zero Touch
- URL
- Phone Lock
- Directory
- Mobile Line

For the features not listed above, refer to [Basic Phone Features](#) on page 155 and [Advanced Phone Features](#) on page 223. For more information, contact your system administrator.

Line

You can use this key feature to accept incoming calls, place active calls on hold or resume a held call.

Dependencies: *Type (Line)*

Account ID (the account this feature will be applied to)

Label (key label displayed on the touch screen)

Usage: When the phone receives an incoming call,

1. Tap the line key to accept the incoming call.
2. Tap the line key to place a new call and the active call is placed on hold.
3. Tap the line key again to resume the held call.

Speed Dial

You can use this key feature to speed up dialing the numbers frequently used or hard to remember.

Dependencies: *Type (Speed Dial)*

Account ID (the account this feature will be applied to)

Label (key label displayed on the touch screen)

Value (the number you want to dial out)

Usage: Tap the speed dial key to dial out the number specified in the **Value** field, using the account selected from the **Account ID** field.

Voice Mail

You can use this key feature to quickly connect voice mail. For more information, refer to [Voice Mail](#) on page 278.

Dependencies: *Type (Key Event)*

Key Type (Voice Mail)

Account ID (the account this feature will be applied to)

Label (key label displayed on the touch screen)

Value (the voice mail access code)

Usage: Tap the voice mail key to dial out the voice mail access code. Then follow the voice prompt to listen to the voice mails.

Direct Pickup

You can use this key feature to answer someone else's incoming call on the phone.

Dependencies: *Type (Key Event)*

Key Type (DPickup)

Account ID (the account this feature will be applied to)

Label (key label displayed on the touch screen)

Value (the directed pickup code followed by the target phone number)

Usage: Tap the directed pickup key on your phone when the target phone number receives an incoming call. The call is then answered on your phone.

Group Pickup

You can use this key feature to answer incoming calls in a group that is associated with their own group.

Dependencies: *Type (Key Event)*

Key Type (GPickup)

Account ID (the account this feature will be applied to)

Label (key label displayed on the touch screen)

Value (the group pickup code)

Usage: Tap the group pickup key on your phone when a phone number in the group receives an incoming call. The call is answered on your phone.

DTMF

You can use this key feature to send the specification of arbitrary key sequences via DTMF.

Dependencies: *Type (Key Event)*

Key Type (DTMF)

Label (key label displayed on the touch screen)

Value (DTMF sequence)

Note

DTMF sequence can only contain "0-9", "*", "#" and "A-D".

Usage: Tap the DTMF key during an active call to send the key sequence specified in the **Value** field.

Prefix

You can use this key feature to add a specified prefix number before the dialing number. You can only configure the SoftKey (1-4) as the prefix key.

Dependencies: *Type (Key Event)*

Key Type (Prefix)

Label (key label displayed on the touch screen)

Value (the prefix number)

Usage: Tap the prefix key when the phone is idle, the phone will then enter the dialing screen and display the prefix number that you specified in the **Value** field. You can enter the remaining digits and then dial out.

Local Group

You can use this key feature to quickly access a contact group in the local directory. For more information, refer to [Local Directory](#) on page 82.

Dependencies: *Type (Key Event)*

Key Type (Local Group)

Local Group (the contact group name you want to access)

Label (key label displayed on the touch screen)

Usage: Tap the local group key to access the contact group specified in the **Local Group** field.

XML Group

You can use this key feature to quickly access a remote group in your remote phone book. You should configure a remote phone book in advance. For more information, refer to [Remote Phone Book](#) on page 102.

Dependencies: *Type (Key Event)*

Key Type (XML Group)

XML Group (the remote group name you want to access if the remote phone book is configured)

Label (key label displayed on the touch screen)

Usage: Tap the XML group key to access the remote group specified in the **XML Group** field.

XML Browser

You can use this key feature to quickly access an XML browser. The XML browser allows you to create custom services which meet your functional requirements on the server. You can customize practical applications, such as weather report, stock information, Google search, etc.

Dependencies: *Type (Key Event)*

Key Type (XML Browser)

Label (key label displayed on the touch screen)

Value (the access URL for XML browser)

Usage: Tap the XML browser key to access the XML browser specified in the **Value** field.

LDAP

You can use this key feature to quickly access a LDAP search screen.

Dependencies: *Type (Key Event)*

Key Type (LDAP)

Label (key label displayed on the touch screen)

Usage:

1. Tap the LDAP key to access the LDAP search screen.
2. Enter a few continuous characters of the contact name or continuous numbers of the contact number.

The contacts whose name or phone number matches the characters entered will appear on the touch screen.

SMS

You can use this key feature to quickly access text message. For more information, refer to [Short Message Service \(SMS\)](#) on page 274.

Dependencies: *Type (Key Event)*

Key Type (SMS)

Label (key label displayed on the touch screen)

Usage: Tap the DSS key when the phone is idle to access text message.

Conference

You can use this key feature to set up a conference call. For more information, refer to [Conference](#) on page 206.

Dependencies: *Type (Key Event)*

Key Type (Conference)

Label (key label displayed on the touch screen)

Value (the number you want to add to the conference)

Usage: Tap the conference key during an active call to set up a conference with the number specified in the **Value** field.

Note

If the **Value** field is left blank, the conference key performs the same as **Conference** during a call.

Forward

You can use this key feature to forward an incoming call to someone else. For more information, refer to [Call Forward](#) on page 192.

Dependencies: *Type (Key Event)*

Key Type (FWD)

Label (key label displayed on the touch screen)

Value (the number you want to forward to)

Usage: Tap the forward key to forward an incoming call to the number specified in the **Value** field.

Note

If the **Value** field is left blank, the forward key performs the same as the **FWD** soft key when receiving an incoming call.

Transfer

When there is an active call on the phone, you can use this key feature to handle the call differently depending on the transfer mode assigned to the DSS key.

Dependencies: *Type (Key Event)*

Key Type (Transfer)

Label (key label displayed on the touch screen)

Value (the number you want to transfer to)

Usage:

- When the transfer mode on DSS key is **Blind Transfer**, tap the transfer key to complete the blind transfer to the number specified in the **Value** field.
- When the transfer mode on DSS key is **Attended Transfer**, tap the transfer key to dial out the number specified in the **Value** field, and then perform the attended or semi-attended transfer.

- When the transfer mode on DSS key is **New Call**, tap the transfer key to place a new call to the number specified in the **Value** field.

Note

Transfer mode via DSS key is configurable via web user interface at the path **Features->Transfer->Transfer Mode via Dsskey**.

If the **Value** field is left blank, the transfer key performs the same as the **TRANSFER** key or the **Transfer** soft key during a call. For more information, refer to [Call Transfer](#) on page 202.

Hold

You can use this key feature to place an active call on hold or retrieve a held call.

Dependencies: *Type (Key Event)*

Key Type (Hold)

Label (key label displayed on the touch screen)

Usage:

1. Tap the hold key during an active call to place the call on hold.
2. Tap the hold key again to retrieve the held call.

DND

You can use this key feature to activate or deactivate DND. You can also use this key feature to access the custom DND screen. For more information, refer to [Do Not Disturb \(DND\)](#) on page 187.

Dependencies: *Type (Key Event)*

Key Type (DND)

Label (key label displayed on the touch screen)

Usage:

When DND is in phone mode:

1. Tap the DND key to activate DND.
2. Tap the DND key again to deactivate DND.

When DND is in custom mode:

1. Tap the DND key to access the custom DND screen. You can activate or deactivate DND for one or all accounts.

Group Listening

You can use this key feature to activate the Speakerphone and Handset/Headset mode at the same time. It is suitable for group conversations which have more than one person at one side. You are able to speak and listen through the handset/headset, while the others nearby can only listen through the speaker.

Dependencies: *Type (Key Event)*

Key Type (Group Listening)

Label (key label displayed on the touch screen)

Usage:

1. During a call, tap the group listening key to activate the group listening mode.
2. You can then speak and listen through the handset/headset, while other people at your side can only listen through the speaker at the same time.
3. Tap the group listening key again to deactivate the group listening mode.

Zero Touch

You can use this key feature to quickly configure auto provision and network parameters.

Dependencies: *Type (Key Event)*

Key Type (Zero Touch)

Label (key label displayed on the touch screen)

Usage:

1. Tap the zero touch key to access the zero touch screen.
2. Tap the **OK** soft key within a few seconds.
3. Configure the network parameters in the corresponding fields.
4. Tap the **Next** soft key.
5. Configure the auto provision parameters in the corresponding fields.
6. Tap the **Next** soft key.

The phone will reboot to update configurations.

URL

You can use this key feature to trigger the phone to send an HTTP GET request containing a specific URL.

Dependencies: *Type (URL)*

Label (key label displayed on the touch screen)

URL (the URL contained in the HTTP GET request)

Usage: Tap the URL key to trigger the phone to send an HTTP GET request containing the URL specified in the **URL** field.

Phone Lock

You can use this key feature to immediately lock your phone instead of long pressing . For more information, refer to [Phone Lock](#) on page 75.

Dependencies: *Type (Phone Lock)*

Label (key label displayed on the touch screen)

Usage: Tap the phone lock key to immediately lock your phone instead of long pressing .

Directory

You can use this key feature to easily access frequently used lists. For more information, refer to [Local Directory](#) on page 82.

Dependencies: *Type (Key Event)*

Key Type (Directory)

Label (key label displayed on the touch screen)

Usage: Tap the directory key to immediately access to frequently used lists.

Note

The directory key performs the same function as the **Directory** key when the phone is idle.

Mobile Line

You can use this key feature to accept incoming mobile calls, place active mobile calls on hold. For more information, refer to [Bluetooth-Enabled Mobile Phone](#) on page 123.

Dependencies: *Type (Mobile Line)*

Label (key label displayed on the touch screen)

Usage: When the IP phone receives an incoming mobile call,

1. Tap the mobile line key to accept the incoming call.
2. Tap the mobile line key to place a new call and the active call is placed on hold.

Programmable Key

You can customize the soft keys and function keys.

To customize programmable key via web user interface:

1. Click on **DSSKey->Programmable Key**.
2. Customize specific features for these keys.

Key	Type	Line	Value	Label	Extension
SoftKey 1	History	Local History			
SoftKey 2	Directory	N/A			
SoftKey 3	DND	N/A			
SoftKey 4	Menu	N/A			
HOLD	N/A	N/A			
Mute	N/A	N/A			
Tran	Forward	N/A			

NOTE

Key Type
The free function key 'Types' Speed Dial, Key Event, Intercom.

Key Event
Key events are predefined shortcuts to phone and call functions.

Intercom
Enable the 'Intercom' mode and it is useful in an office environment as a quick access to connect to the operator or the secretary.

You can click here to get more guides.

3. (Optional.) Enter the string that will appear on the touch screen in the **Label** field. Label is configurable only when customizing SoftKey (1-4).

4. Click **Confirm** to accept the change.

You can click **Reset to default** to reset custom settings to defaults.

Then you can press the keys on the phone to perform the features you configured.

For example:

Switch Account Up

You can press **Switch Account Up** key to change the default account.

Dependencies: Type (*Switch Account Up*)

Usage: Press the **Switch Account Up** key to scroll up the account list to select the desired default account.

Switch Account Down

You can press **Switch Account Down** key to change the default account.

Dependencies: Type (*Switch Account Down*)

Usage: Press the **Switch Account Down** key to scroll down the account list to select the desired default account.

Note

Programable keys are configurable via web user interface only.

Account Management

Account Registration

To register an account via phone user interface:

1. Tap  ->**Advanced** (default password: admin) ->**Account**.
2. Tap the desired account.
3. Tap the **Activation** field.
4. Tap **Enabled** in the pop-up dialog box.

5. Enter the desired value in the **Label**, **Display Name**, **Register Name**, **User Name**, **Password** and **SIP Server1/2** field respectively. Contact your system administrator for more information.

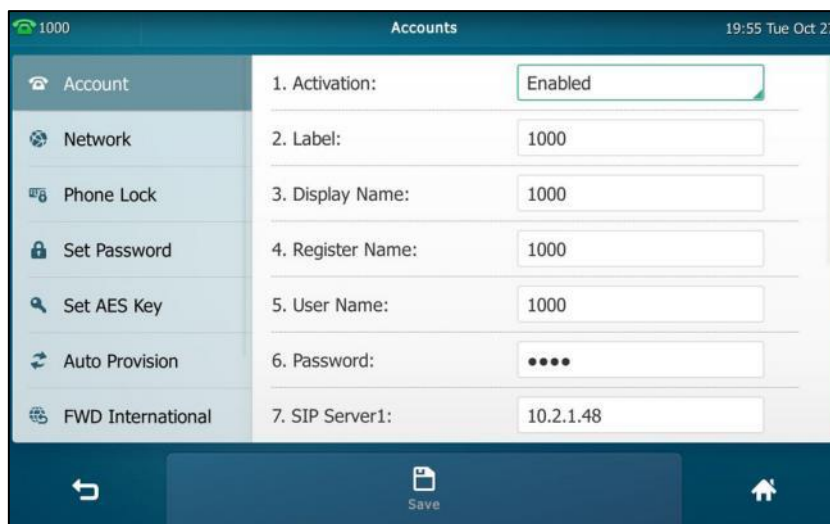

6. If you use the outbound proxy servers, do the following:
 - 1) Tap the **Outbound Status** field.
 - 2) Tap **Enabled** in the pop-up dialog box.
 - 3) Enter the desired value in the **Outbound Proxy1/2** and **Proxy Fallback Interval** field respectively. Contact your system administrator for more information.
7. Tap the **Save** soft key to accept the change or  to cancel.



You can repeat steps 2 to 7 to register more accounts.

The following figures demonstrate single or multiple accounts registered on the phone:

Single account:



Multiple accounts:**To disable an account via phone user interface:**

1. Tap  -> **Advanced** (default password: admin) -> **Account**.
2. Tap the desired account.
3. Tap the **Activation** field.
4. Tap **Disabled** in the pop-up dialog box.
5. Tap the **Save** soft key to accept the change or  to cancel.

Account registration is configurable via web user interface at the path **Account->Register**.

Default Account**To configure the default account via phone user interface:**

1. Tap  -> **Features**-> **Default Account**.
2. Tap the **Default Account** field.

3. Tap the desired account in the pop-up dialog box.

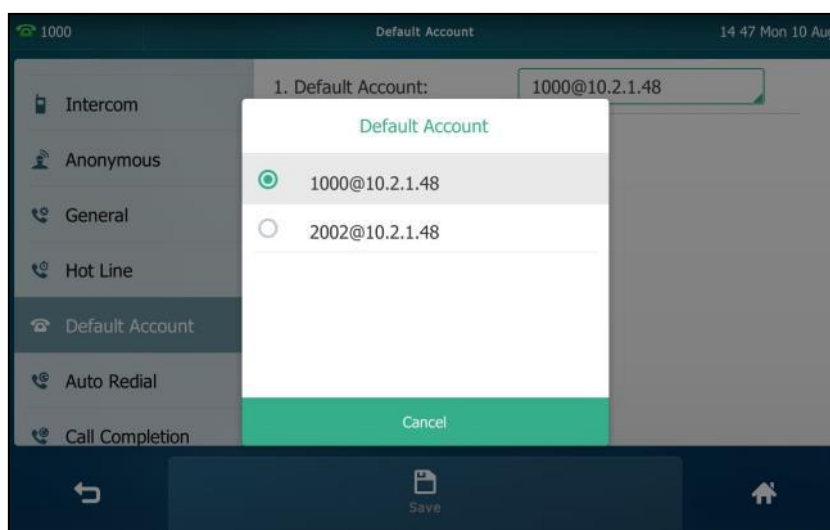

4. Tap the **Save** soft key to accept the change or  to cancel.

The label of the default account is displayed on the left of the status bar. The IP phone will use this account by default when dialing out.

You can also tap the label of the default account, and then tap the desired account to be the new default account.

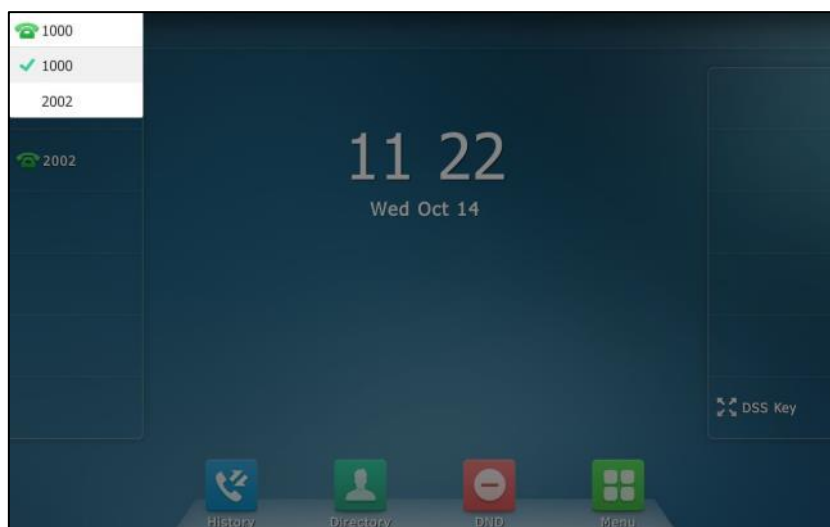

Multiple Line Keys per Account

You can configure multiple line keys to associate with an account. This enhances call visualization and simplifies call handling.

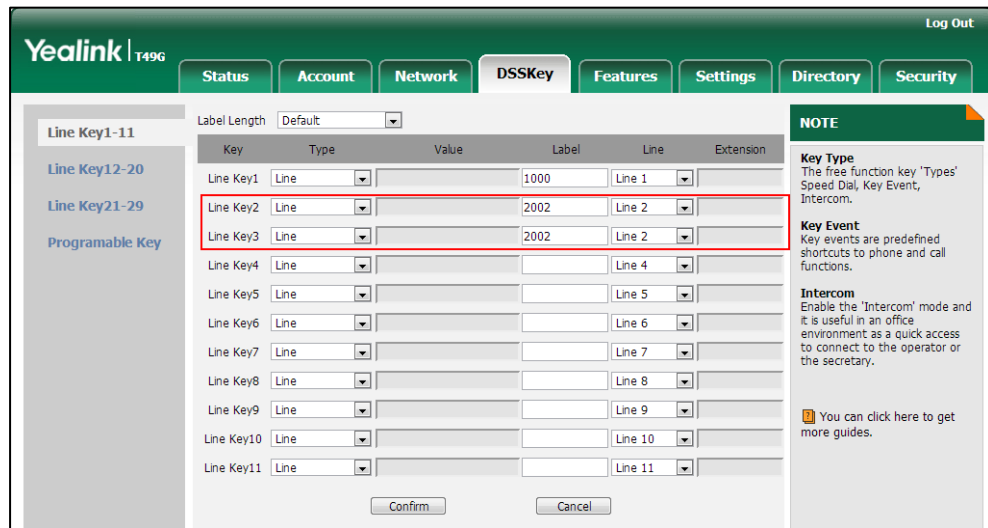

If this is the case, the touch screen will resemble the following figure:



Incoming calls to this account will be distributed evenly among the available line keys. Outgoing calls will be distributed similarly.

Your phone can be configured to have a combination of accounts with a single line key and accounts with multiple line keys.

Dial Plan

Dial plan is a string of characters that governs the way your SIP VP-T49G IP phone processes the inputs received from your phone keypad. The SIP VP-T49G IP phone supports the following dial plan features:

- [Replace Rule](#)
- [Dial-now](#)
- [Area Code](#)
- [Block Out](#)

Basic expression syntaxes you need to know:

.	The dot "." can be used as a placeholder or multiple placeholders for any character. Example: "12." would match "123", "1234", "12345", "12abc", etc.
x	An "x" can be used as a placeholder for any character. Example: "12x" would match "121", "122", "123", "12a", etc.
-	Numeric ranges are allowed within the brackets: Digit "-" Digit. Example: "[5-7]" would match the number "5", "6" or "7".
[]	The square brackets "[]" can be used as a placeholder for a single character which matches any of a set of characters. Example: "91[5-7]1234" would match "9151234", "9161234", "9171234".
()	The parentheses "()" can be used to group together patterns, for instance, to logically combine two or more patterns. Example: "([1-9])([2-7])3" would match "923", "153", "773", etc.
\$	The "\$" should be followed by the sequence number of a parenthesis. The "\$" plus the sequence number means the whole character or characters placed in the parenthesis. The number directs to the right parenthesis when there are more than one. Example: A replace rule configuration, Prefix: "001(xxx)45(xx)", Replace: "9001\$145\$2". When you dial out "0012354599" on your phone, the IP phone will replace the number with "90012354599". "\$1" means 3 digits in the first parenthesis, that is, "235". "\$2" means 2 digits in the second parenthesis, that is, "99".

Note

Dial plan is configurable via web user interface only.

Replace Rule

You can configure one or more replace rules (up to 100) to remove the specified string and replace it with another string. You can configure a pattern with wildcards (refer to

the expression syntax in the table above), so that any string that matches the pattern will be replaced. This feature is convenient for you to dial out a long number. For example, a replace rule is configured as “Prefix: 1” and “Replace: 1234”, when you try to dial out the number “1234”, you just need to enter “1” on the phone and then tap **Send**.

To add a replace rule via web user interface:

1. Click on **Settings->Dial Plan->Replace Rule**.
2. Enter the string (e.g., 1) in the **Prefix** field.
3. Enter the string (e.g., 1234) in the **Replace** field.
4. Enter the desired line ID in the **Account** field or leave it blank.

5. Click **Add** to add the replace rule.
When you enter the number “1” using the keypad or the onscreen keyboard and then tap **Send**, the phone will dial out “1234” instead.

Note

The valid values for the **Account** field can be one or more digits among 1-16. Every two digits must be separated by a comma. For example, when you enter the value “1, 2” in the **Account** field, this replace rule will apply to account1 and account2.

If you leave the **Account** field blank or enter 0, the replace rule will apply to all accounts.

To edit a replace rule via web user interface:

1. Click on **Settings->Dial Plan->Replace Rule**.
2. Select the desired replace rule by checking the checkbox.
3. Edit the values in the **Prefix** and **Replace** fields.
4. Enter the desired line ID in the **Account** field or leave it blank.
5. Click **Edit** to accept the change.

To delete one or more replace rules via web user interface:

1. Click on **Settings->Dial Plan->Replace Rule**.
2. Select one or more replace rules by checking the checkbox(es).
3. Click **Del** to delete the replace rule(s).

Dial-now

You can configure one or more dial-now rules (up to 100) on your phone. When the dialed number matches the dial-now string, the number will be dialed out automatically. For example, a dial-now rule is configured as "2xx", any entered three-digit string beginning with 2 will then be dialed out automatically on the phone.

To add a dial-now rule via web user interface:

1. Click on **Settings->Dial Plan->Dial-now**.
2. Enter the desired value (e.g., 2xx) in the **Rule** field.
3. Enter the desired line ID in the **Account** field or leave it blank.

For more information on the valid values for the **Account** field, refer to [Replace Rule](#) on page 146.

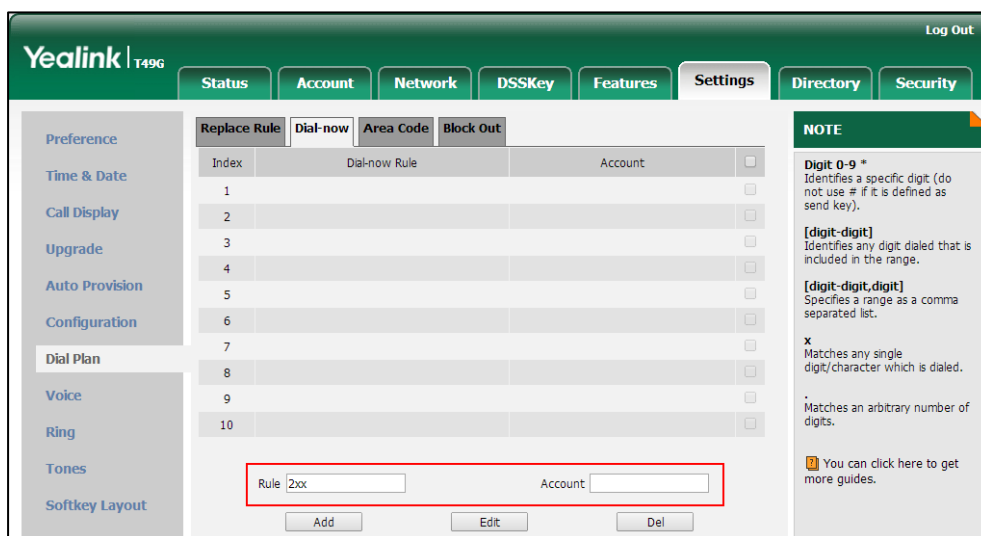

4. Click **Add** to add the dial-now rule.

When you enter the number "234" using the keypad or the onscreen keyboard, the phone will dial out "234" automatically without the pressing of any key.

Note

You can also edit or delete the dial-now rule. For more information, refer to [Replace Rule](#) on page 146.

Delay Time for Dial-Now Rule

You can configure the delay time for dial-now rules. That is, you can configure your phone to automatically dial out the phone number which matches a dial-now rule, after

the designated delay time.

To configure the delay time for dial-now rule via web user interface:

1. Click on **Features->General Information**.
2. Enter the time between 0 and 14 (seconds) in the **Time-Out for Dial-Now Rule** field.
The default value is "1".

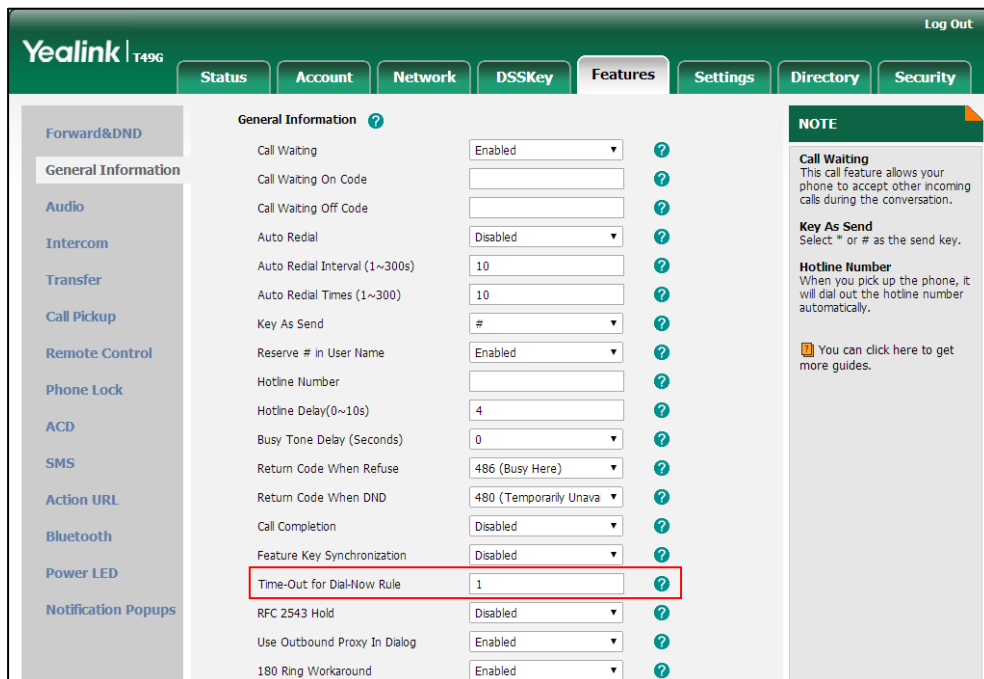

3. Click **Confirm** to accept the change.

Note Delay time for dial-now rule is configurable via web user interface only.

Area Code

Area codes are also known as Numbering Plan Areas (NPAs). They usually indicate geographical areas in a country. This feature is necessary when dialing a phone number outside the code area. For example, an area code is configured as "Code: 0592, Min Length: 1, Max Length: 15". When you dial out the number "56789" (the length of the number is between 1 and 15), the phone will add the area code and dial out the number "059256789". You can only configure one area code rule on your phone.

To configure the area code and lengths via web user interface:

1. Click on **Settings->Dial Plan->Area Code**.
2. Enter the desired values in the **Code, Min Length (1-15)** and **Max Length (1-15)** fields.

3. Enter the desired line ID in the **Account** field or leave it blank.

For more information on the valid values for the **Account** field, refer to [Replace Rule](#) on page 146.

The screenshot shows the Yealink T49G web interface. The top navigation bar includes 'Status', 'Account', 'Network', 'DSSKey', 'Features', 'Settings', 'Directory', and 'Security'. The 'Settings' tab is active, and the 'Block Out' sub-tab is selected. The main content area contains a form with the following fields:

- Code:** 0592
- Min Length (1-15):** 1
- Max Length (1-15):** 15
- Account:** (empty)

Below the form are 'Confirm' and 'Cancel' buttons. A 'NOTE' section on the right provides the following information:

- Digit 0-9 *** Identifies a specific digit (do not use # if it is defined as send key).
- [digit-digit]** Identifies any digit dialed that is included in the range.
- [digit-digit,digit]** Specifies a range as a comma separated list.
- x** Matches any single digit/character which is dialed.

4. Click **Confirm** to accept the change.

Note The default value of minimum and maximum length is 1 and 15 respectively.

Block Out

You can block some specific numbers (up to 10) from being dialed on your phone. When you dial a block out number on your phone, the dialing will fail and the touch screen will prompt "Forbidden Number".

To add a block out number via web user interface:

1. Click on **Settings->Dial Plan->Block Out**.
2. Enter the desired value in the **BlockOut Number** field.
3. Enter the desired line ID in the **Account** field or leave it blank.

For more information on the valid values for the **Account** field, refer to [Replace Rule](#) on page 146.

The screenshot shows the Yealink T49G web interface. The top navigation bar includes 'Status', 'Account', 'Network', 'DSSKey', 'Features', 'Settings', 'Directory', and 'Security'. The 'Settings' tab is active, and the 'Block Out' sub-tab is selected. A table lists 'BlockOut Number1' through 'BlockOut Number10'. The 'BlockOut Number1' field is highlighted with a red box and contains the value '1000'. The 'Account' field for 'BlockOut Number1' is empty. A 'NOTE' section on the right provides details on digit notation: 'Digit 0-9 *' identifies a specific digit, '[digit-digit]' identifies a range, '[digit-digit,digit]' identifies a range with a comma-separated list, 'x' matches a single digit/character, and '.' matches an arbitrary number of digits. 'Confirm' and 'Cancel' buttons are at the bottom.

4. Click **Confirm** to add the block out number.

Emergency Number

Public telephone networks in countries around the world have a single emergency telephone number (emergency services number), that allows a caller to contact local emergency services for assistance when necessary. The emergency telephone number may differ from country to country. It is typically a three-digit number so that it can be easily remembered and dialed quickly. Some countries have a different emergency number for each of the different emergency services.

You can specify the emergency telephone numbers on the IP phone for contacting the emergency services in an emergency situation. You can dial these numbers when the phone is locked. For more information on phone lock refer to [Phone Lock](#) on page 75.

Note

Contact your local phone service provider for available emergency numbers in your area.

To specify emergency numbers via web user interface:

1. Click on **Features->Phone Lock**.
2. Enter the emergency number in the **Emergency** field.

For multiple emergency numbers, enter a comma between every two numbers.
The default emergency numbers are 112, 911 and 110.

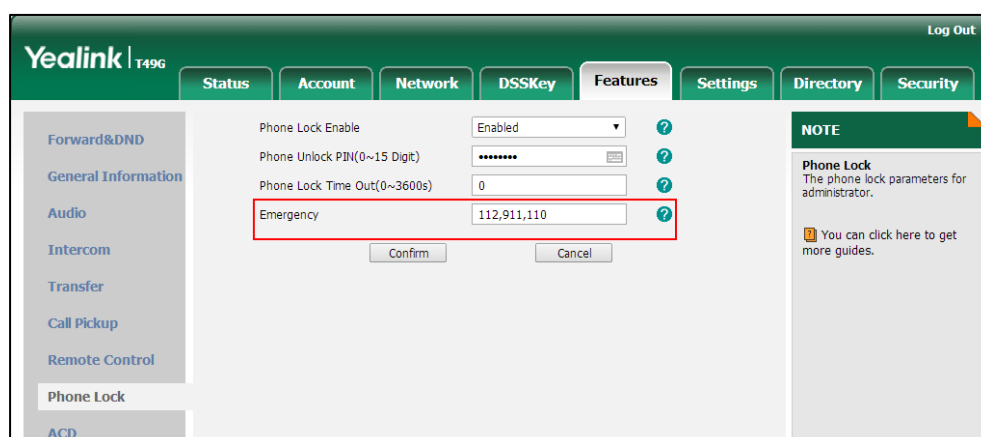

3. Click **Confirm** to accept the change.

Note Emergency number is configurable via web user interface only.

Live Dialpad

You can enable live dialpad on the SIP VP-T49G IP phone, which enables the IP phone to automatically dial out a phone number without the pressing of the send key. You can also configure a delay, where the phone will dial out the phone number automatically after the designated period of time.

To enable the live dialpad via web user interface:

1. Click on **Settings->Preference**.
2. Select **Enabled** from the pull-down list of **Live Dialpad**.
3. Enter the desired delay time in the **Inter Digit Time(1~14s)** field.

The default delay time is 4.

The screenshot shows the Yealink T49G web interface. The 'Settings' tab is active. A red box highlights the 'Live Dialpad' and 'Inter Digit Time(1~14s)' settings. The 'Inter Digit Time' is set to 4. Other settings include Language (English), Backlight Inactive Level (Low), Backlight Active Level (8), Backlight Time (Always On), WatchDog (Enabled), Ring Type (Ring1.wav), Wallpaper (Default.png), and Screensaver Wait Time (30min). There are 'Confirm' and 'Cancel' buttons at the bottom.

4. Click **Confirm** to accept the change.

Note

Live dialpad is configurable via web user interface only.

Hotline

You can dial a hotline number immediately upon lifting the handset, pressing the Speakerphone key or tapping the line key. You can also configure a delay, where the phone will dial out the hotline number automatically after a designated period of time.

To configure the hotline number via phone user interface:

1. Tap  -> **Features**-> **Hot Line**.
2. Enter the desired number in the **Number** field.

3. Enter the desired delay time in the **Hotline Delay 0-10(s)** field.
The default value is "4".

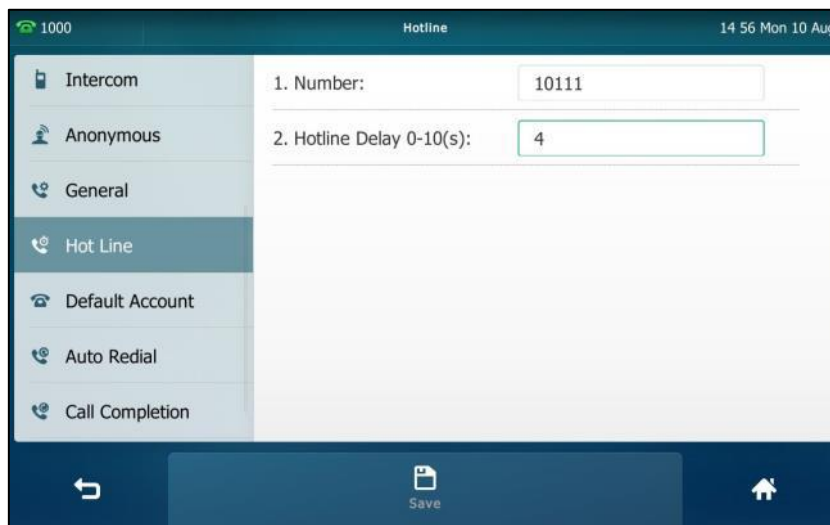

4. Tap the **Save** soft key to accept the change or  to cancel.

Hotline is configurable via web user interface at the path **Features->General Information**.

Basic Phone Features

The SIP VP-T49G IP phone is designed to be easily used like a regular phone on a public switched telephone network (PSTN). You can place calls, answer calls, transfer a call to someone else, or conduct a conference call.

This chapter provides basic operating instructions for the SIP VP-T49G IP phone. Topics include:

- [Placing Calls](#)
- [Answering Calls](#)
- [Ending Calls](#)
- [Changing Video Call Settings](#)
- [External Monitor](#)
- [Redialing Numbers](#)
- [Recent Call In Dialing](#)
- [Auto Answer](#)
- [Auto Redial](#)
- [Call Completion](#)
- [Recall](#)
- [Call Mute](#)
- [Call Hold/Resume](#)
- [Do Not Disturb \(DND\)](#)
- [Call Forward](#)
- [Call Transfer](#)
- [Call Waiting](#)
- [Conference](#)
- [Call Park](#)
- [Call Pickup](#)
- [Anonymous Call](#)
- [Anonymous Call Rejection](#)
- [Capturing Screenshots during a Video Call](#)
- [Viewing the Pictures Stored in Your USB Flash Drive](#)

Placing Calls

You can place a call in one of three ways using your SIP VPT49G IP phone:

- Using the handset
- Using the speakerphone
- Using the headset

You can also dial the number first, and then choose the way you want to speak to the other party.

You can also dial an entry/contact from call history, local directory or remote phone book. For more information, refer to [Contact Management](#) on page 82 and [Call History Management](#) on page 109.

By default, you can set up a video call with the other party that is video-enabled. The IP phone can set up video calls with only two parties (even if more than two parties that set up a call with you can send video). To place an audio-only call, make sure the video feature is disabled. For more information, refer to [Changing the Video Settings](#) on page 168.

During a call, you can alternate between Speakerphone, Headset, and Handset modes by pressing the Speakerphone key, the HEADSET key, or by picking up the handset.

The call duration of the call and far-site's information (name or phone number) are visible on the touch screen. In the figure below, the call to "Habas Duo" has lasted 7 seconds.

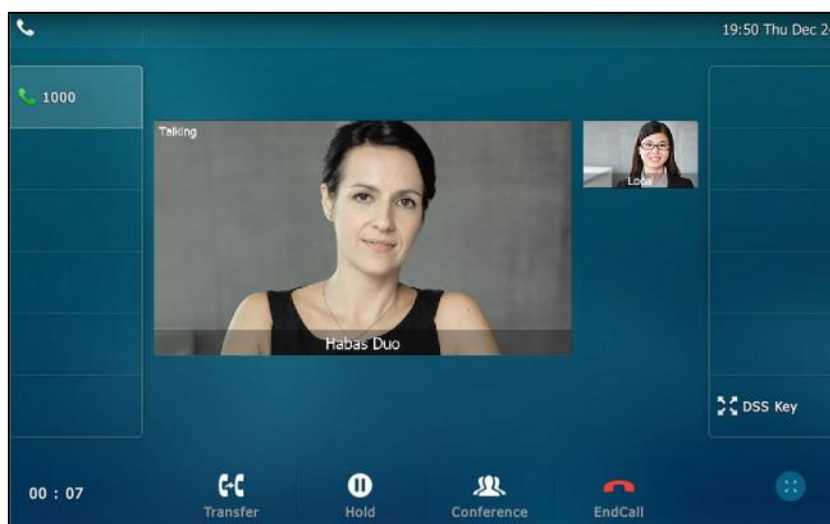

Note

The phone will enter the video call full-screen within 5 seconds during a call, you may tap  or blank area at the top or bottom of the screen to see the soft keys.

To place a call using the handset:

1. Pick up the handset.

2. Enter the desired number using the keypad or the dial pad.

You can enter the number using the onscreen keyboard.



3. Press , or tap **Send**.

The # key is configured as a send key by default. You can also set the * key as the send key, or set neither. For more information, refer to the [Key as Send](#) on page 74.

You can also tap **History** or **Directory** to search for an entry or contact after picking up the handset, and then tap the desired entry or contact to place a call.





Note

You can also dial using the SIP URI or IP address. To obtain the IP address of a phone, tap  -> **Status**, when the phone is idle. The maximum SIP URI or IPv4 address length is 32 characters. For example, SIP URI: 3606@sip.com, IP: 192.168.1.15.

Your phone may not support direct IP dialing. Contact your system administrator for more information.





To place a call using the hands-free speakerphone mode:

Do one of the following:

- With the handset on-hook, press  or tap the line key to obtain a dial tone.
Enter the desired number using the keypad or the dial pad.
Press  or tap **Send**.
- With the handset on-hook, enter the desired number using the keypad or the dial pad.
Press ,  or tap **Send**.

To place a call using the headset:

Do one of the following:

- With the optional headset connected, press  to activate the headset mode.
Tap the line key to obtain a dial tone.
Enter the desired number using the keypad or the dial pad.
Press  or tap **Send**.
- With the optional headset connected, press  to activate the headset mode.
Enter the desired number using the keypad or the dial pad.
Press  or tap **Send**.



Note

To permanently use the headset mode, refer to [Headset Prior](#) on page 115.

The SIP VP-T49G IP phone can handle multiple calls at a time. However, only one active call (the call that has audio associated with it) can be in progress at any time. The SIP VP-T49G IP phone can handle a maximum of 50 calls at one time.

To place multiple calls:

You can have more than one call on your SIP VP-T49G IP phone. To place a new call during an active call, do one of the following:

- Tap the line key. The active call is placed on hold.
Enter the desired number using the keypad or the dial pad.
Press  or tap **Send**.
- Press  or tap the **Hold** soft key to place the original call on hold.
Tap the **NewCall** soft key.
Enter the desired number using the keypad or the dial pad.
Press  or tap **Send**.

You can tap the desired call, and then tap the **Resume** soft key to retrieve it.

Note

If multiple accounts are registered on the phone, you can first tap the desired line key on the idle screen or tap the desired line from the status bar in dialing screen, and then you can use the selected account to place a call.

Answering Calls

When you are not in another call, you can answer a call in one of three ways:

- Using the handset
- Using the speakerphone

- Using the headset

Note

You can reject incoming calls by tapping the **Reject** soft key to stop the phone from playing ring tone. You can also activate the Do Not Disturb mode to reject the incoming calls without ringing on your phone. For more information, refer to [Do Not Disturb \(DND\)](#) on page 187.

You can forward incoming calls to someone else by tapping the **FWD** soft key. For more information, refer to [Call Forward](#) on page 192.

Answering When Not in Another Call

Call duration and destination will always appear on the touch screen for the active call.

To answer a call using the handset:

1. Pick up the handset.

To answer a call using the hands-free speakerphone mode:

Do one of the following:

- Press  .
- With the handset on-hook and the headset mode deactivated, tap the **Answer** soft key.
- With the handset on-hook and the headset mode deactivated, tap the line key.

To answer a call using the headset:

Do one of the following:

- Press  .
- With the headset mode activated, tap the **Answer** soft key.
- With the headset mode activated, tap the line key.

Answering When in Another Call

If you have an active call, and an incoming call arrives on the phone. The incoming call information is displayed on the touch screen.

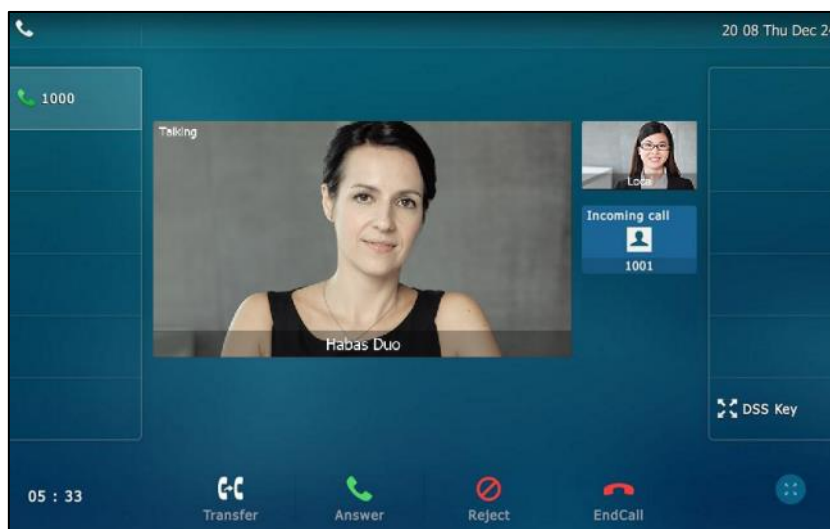

Do one of the following:

- Tap the **Answer**.
- Tap the incoming call avatar.

Tap the **Answer**.

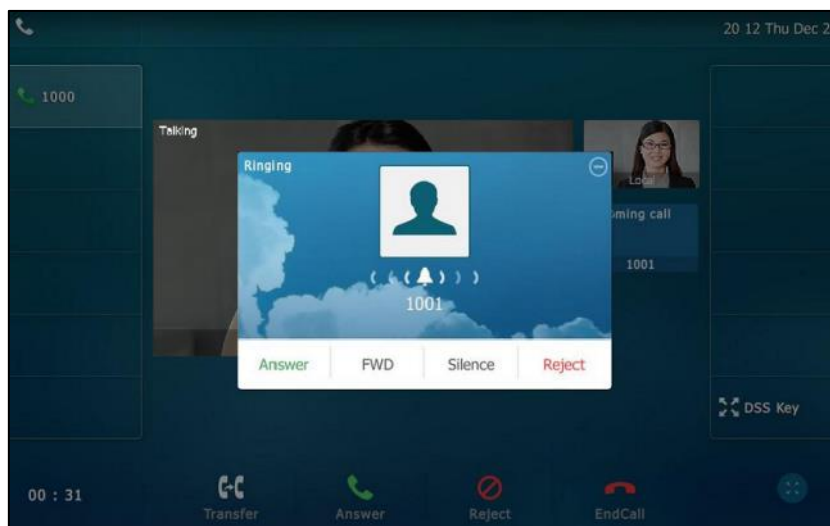

The incoming call is answered and the original call is placed on hold.

Ending Calls

To end a call:

Do one of the following:

- If you are using the handset, tap the **EndCall** soft key or hang up the handset.
- If you are using the headset, tap the **EndCall** soft key.
- If you are using the speakerphone, press  or tap the **EndCall** soft key.

Note

To end a call placed on hold, you can tap the **EndCall** soft key to end the call directly, or tap the **Resume** soft key to resume the call before ending it.

Changing Video Call Settings

When you update video settings, you can change the way for the current video call or all video calls to display on your IP phone.

You can update the following video settings on your phone:

- Stopping Transmitting Video during a Call
- Changing the Clarity of Near-Site Video
- Changing the Video Settings
- Changing the Video Layout during Calls
- Previewing the Near-Site Video

Stopping Transmitting Video during a Call

You can stop your phone from automatically transmitting your video during a video call. However, you cannot turn off far-site video.

There are three ways to stop transmitting video during an active video call:

- Press .
- Swipe down from the top of the screen in the video call screen (refer to [Video Call Screen Display](#)), and then tap **Video**.
- Turn off shutter switch.

If you stop transmitting video, the icon  will display on the near-site video, as shown below:

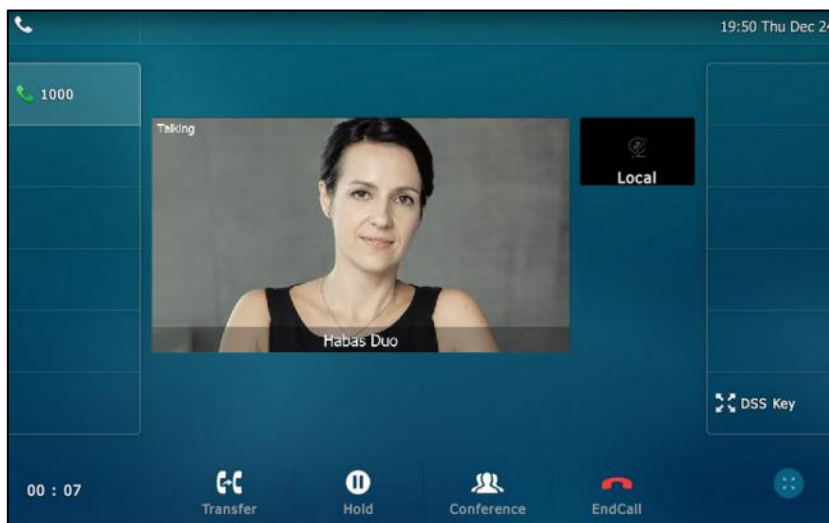

Your camera will not transmit video to your contact and the far site cannot see you.

Stopping transmitting video does not create an audio-only call. Even if you stop transmitting video, you can see the other party, and the call is still a video call. To place an audio-only call, contact your system administrator.

Changing the Clarity of Near-Site Video

You can change the clarity of your video, including the sharpness, brightness and contrast of your video stream before a video call. If your camera faces a bright light source, such as a bright window, you may need to increase the camera's sharpness, brightness and contrast levels so the other party can have a better video call experience with you.

Scene Mode

SIP VP-T49G IP phone provides four scene modes – standard mode, warm color mode, cool color mode and manual mode. You can select one of them to obtain a better video call experience if required. If you select manual mode, you may need to know how to set parameters of camera in advance (e.g., white balance, sharpness and brightness).

To configure scene mode via phone user interface:

1. Tap  -> **Basic**->**Camera Setting**.
2. Tap the **Scene Mode** field.

3. Tap the desired item in the pop-up dialog box.

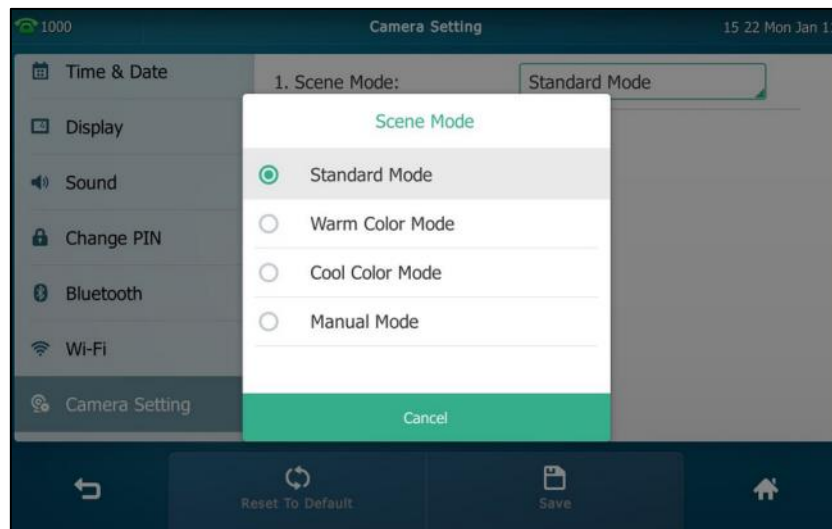

4. Tap the **Save** soft key.

The touch screen will prompt "Save succeeded! Preview the video effect?".

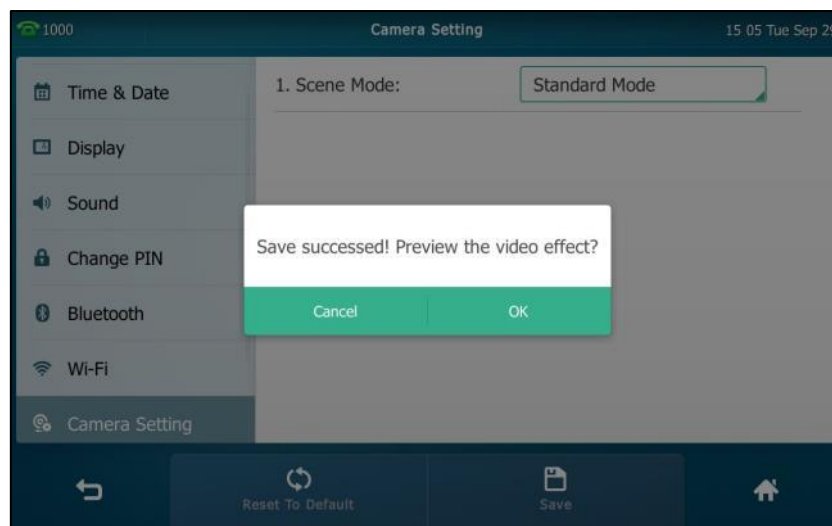

5. Tap **OK** to accept the change and preview the video or **Cancel** to go back to the menu screen.

Scene mode is configurable via web user interface at the path **Settings->Camera**.

You can also select scene mode when previewing the near-site video. For more information, refer to [Previewing the Near-Site Video](#) on page 174.

To configure manual scene mode via phone user interface:

1. Tap  -> **Basic->Camera Setting**.
2. Tap the **Scene Mode** field.

3. Tap **Manual Mode** in the pop-up dialog box.

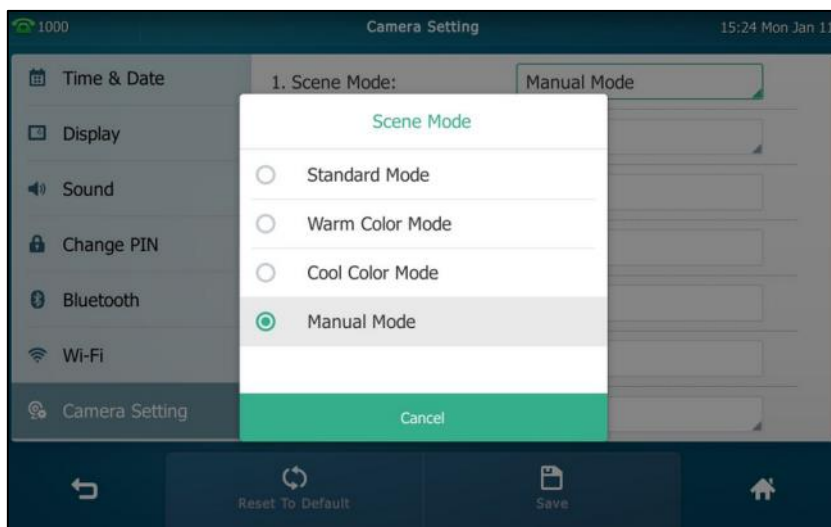

4. Tap the **White Balance** field.
5. Tap **Auto** or **Manual Mode** in the pop-up dialog box.
6. (Optional.) Enter the desired value in the **Red Gain** and **Blue Gain** field respectively.

Red Gain and **Blue Gain** fields appear only if **White Balance** field is set to **Manual Mode**.

Red Gain - Sets how red your video displays. You can set a level between 0 (normal) and 100 (most). The default level is 0.

Blue Gain - Sets how blue your video displays. You can set a level between 0 (normal) and 100 (most). The default level is 0.

7. Enter the desired value in the **Sharpness**, **Brightness**, **Contrast Setting** and **Saturation** field respectively.

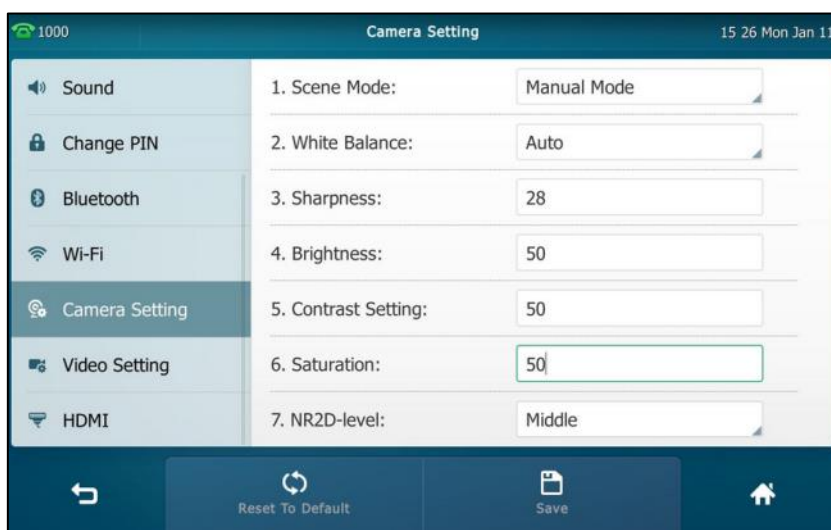

Sharpness - Sets the clarity of detail in your video. You can set a level between 0 (lowest) and 100 (highest). The default level is 50.

Brightness - Sets how brightly your video displays. You can set a level between 0 (dimmiest) and 100 (brightest). The default level is 50.

Contrast Setting - Sets the difference in brightness between the light and dark areas of your video. You can set a level between 0 (no contrast increase) and 100 (highest). The default level is 0.

Saturation - Sets how much color your video displays. You can set a level between 0 (lowest) and 100 (highest). The default level is 100.

8. Tap the **NR2D-level** field.

NR2D-level – Sets the level to reduce the image noise. You can set to Off, Low, Middle and High. The default value is Middle.

9. Tap the desired item in the pop-up dialog box.

10. Tap the **Save** soft key.

The touch screen prompts “Save succeeded! Preview the video effect?”.

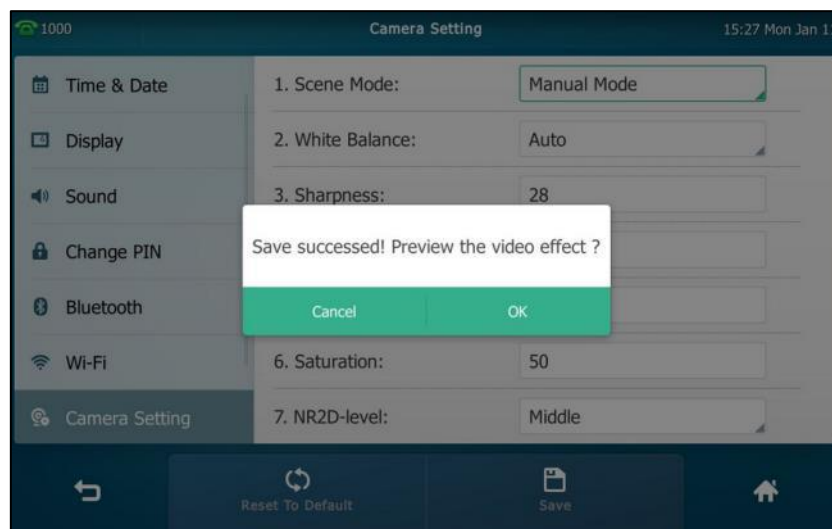

11. Tap **OK** to accept the change and preview the video or **Cancel** to go back to the menu screen.

Manual scene mode is configurable via web user interface at the path **Settings->Camera**.

To reset manual settings via phone user interface:

1. Tap  -> **Basic->Camera Setting**.

2. Tap the **Reset To Default** soft key.

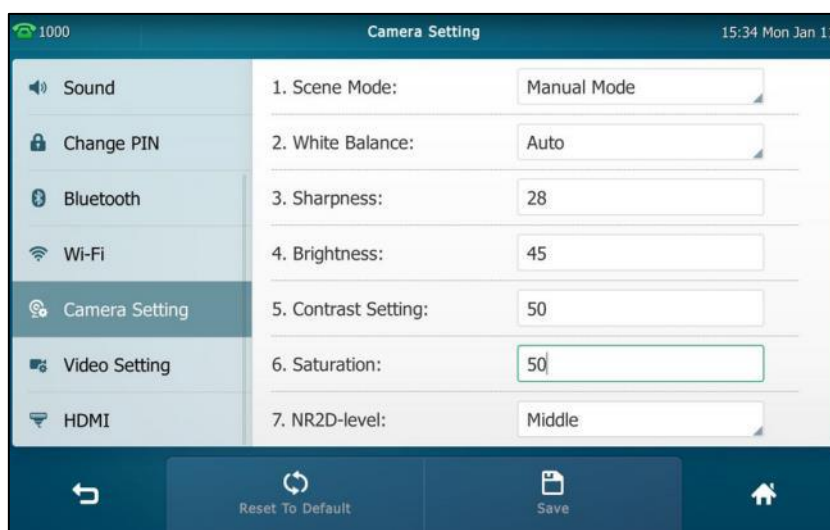

The touch screen prompts “Reset to default setting?”.

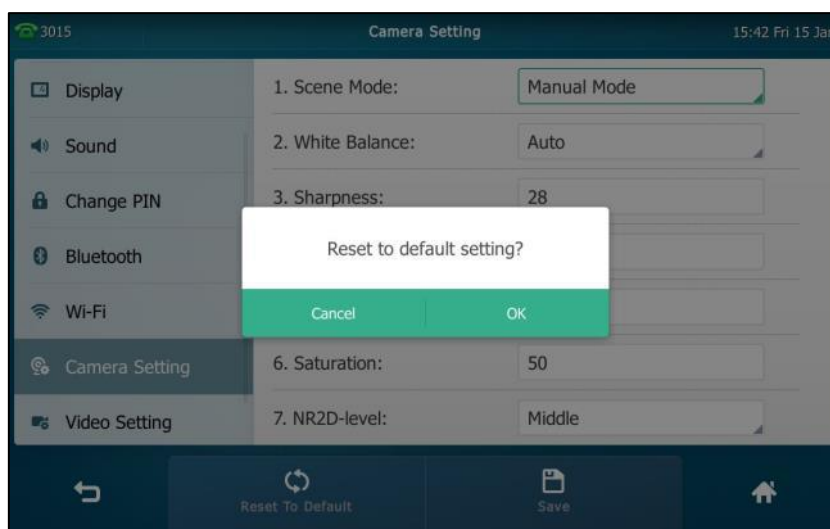

3. Tap **OK** to accept the change or **Cancel** to cancel.

Reset Manual Settings is configurable via web user interface at the path **Settings->Camera**.

Exposure

Exposure compensation is used to compensate the camera effectively when shooting in a backlight environment. If the environment light is dark, increase the compensation value.

To configure exposure via web user interface:

1. Click on **Setting->Camera**.
2. Select the desired value from the pull-down list of **Exposure Compensation**, or select **Off** to turn off exposure compensation.

The value of exposure compensation ranges from 1 (lowest)-3 (highest), the default value is Off.

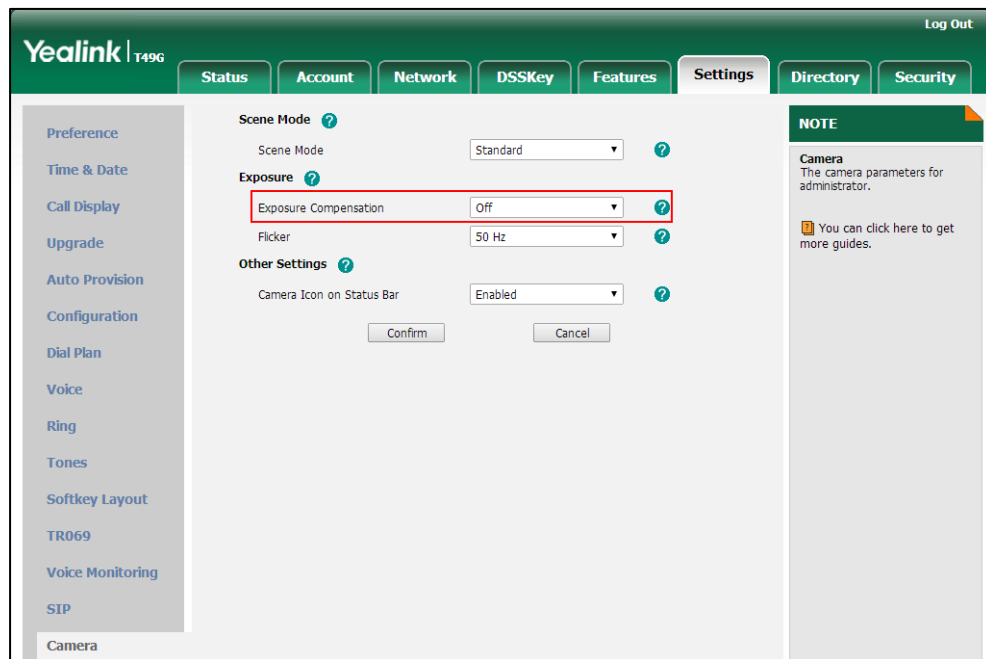

3. Select the desired value from the pull-down list of **Flicker**.

Flicker - Adjusts the flickering of your video captured by the camera sensor. You can set to 50 Hz (flicker avoidance for Europe and Asia) or 60 Hz (flicker avoidance for North America). The default value is 50 Hz.

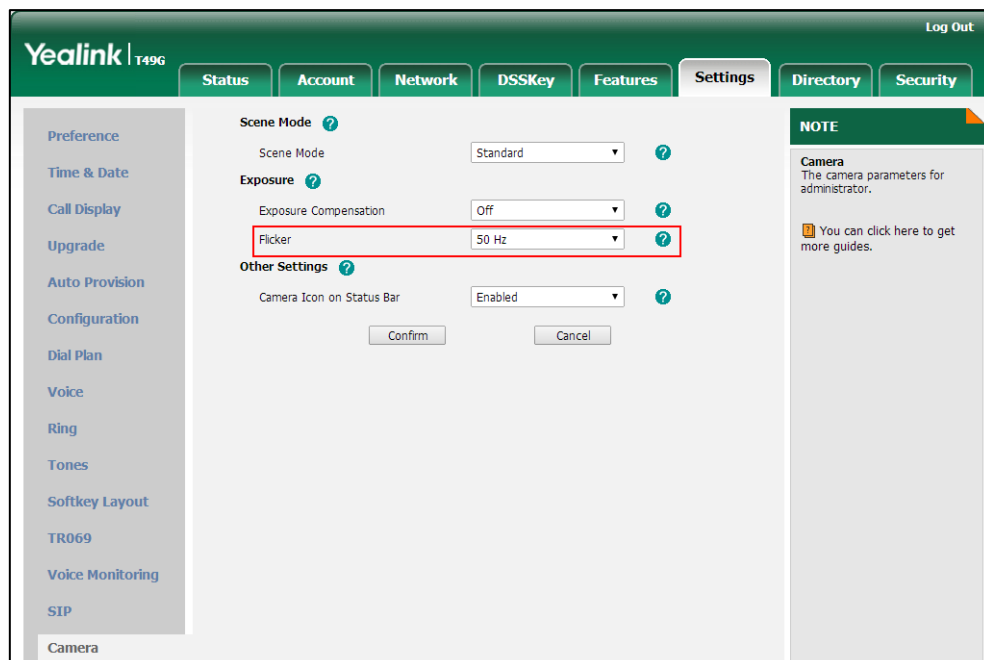

4. Click **Confirm** to accept the change.

Note Exposure can be configurable via web user interface only.

Changing the Video Settings

You can change the setting of your video via phone user interface or web user interface, including video enable, auto start video, auto answer video mute, uplink bandwidth and downlink bandwidth.

To configure the video settings via phone user interface:

1. Tap  ->Basic->Video Setting.
2. Tap the **Video Enable**, **Auto Start Video**, **Auto Answer Video Mute**, **Uplink Bandwidth** or **Downlink Bandwidth** field respectively.

Video Enable – Enables or disables the IP phone to use camera during a call. You can set to Enabled or Disabled. The default value is Enabled. If you set to Disabled, the IP phone can only place/receive an audio-only call.

Auto Start Video – Enables or disables the IP phone to transmit near-site video at once for all incoming calls. You can set to Enabled or Disabled. The default value is Enabled.

Auto Answer Video Mute – Enables or disables the IP phone not to transmit the video when an incoming call is automatically answered. You can set to Enabled or Disabled. The default value is Disabled.

Uplink Bandwidth – Sets the maximum uplink bandwidth of video call. You can set to Auto, 4000kb/s, 3000kb/s, 2000kb/s, 1500kb/s, 1280kb/s, 1024kb/s, 768kb/s, 640kb/s, 512kb/s, 384kb/s or 256kb/s. The default value is Auto.

Downlink Bandwidth – Sets the maximum downlink bandwidth of video call. You can set to Auto, 4000kb/s, 3000kb/s, 2000kb/s, 1500kb/s, 1280kb/s, 1024kb/s, 768kb/s, 640kb/s, 512kb/s, 384kb/s or 256kb/s. The default value is Auto.

3. Tap the desired value in the pop-up dialog box.

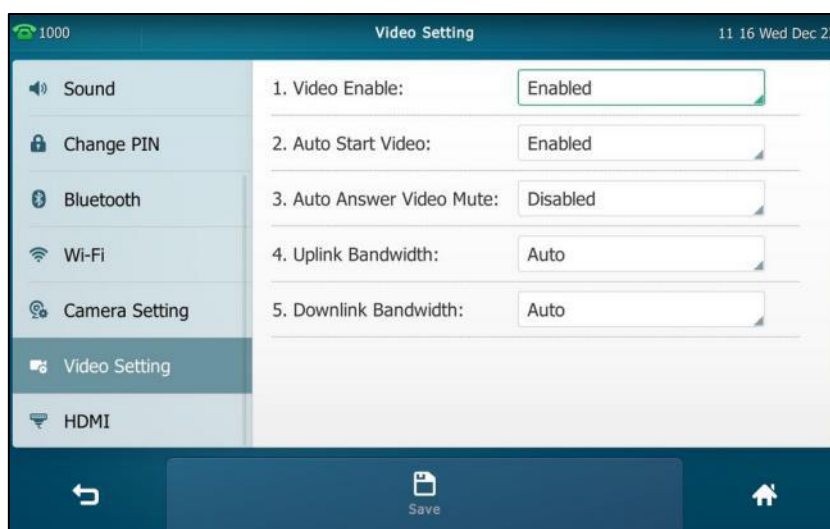

4. Tap the **Save** soft key.

The touch screen will prompt “Save succeeded!”.

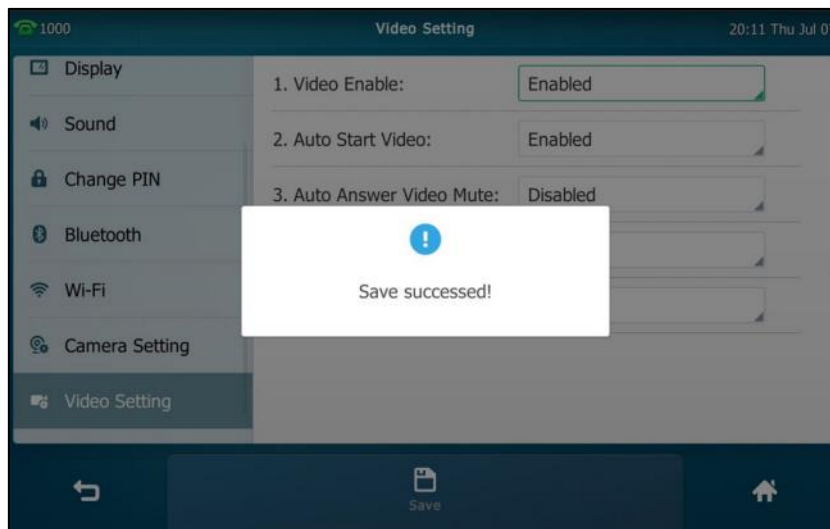

Video setting is configurable via web user interface at the path **Settings->Video**.

Changing the Video Layout during Calls

During video calls, near-site and far-site video images are displayed on the touch screen. You can change the video layout.

The system supports three video layouts:

- One large, other small: One video image displays in a large size, the other video images along the right side of the screen displays in small sizes.
- Full screen: One video image displays in full size, the other video images are hidden.
- Same size: All video images display in the same size.

To swap video during a video call via phone user interface:

1. Tap the near-site (small window) video during a video call.

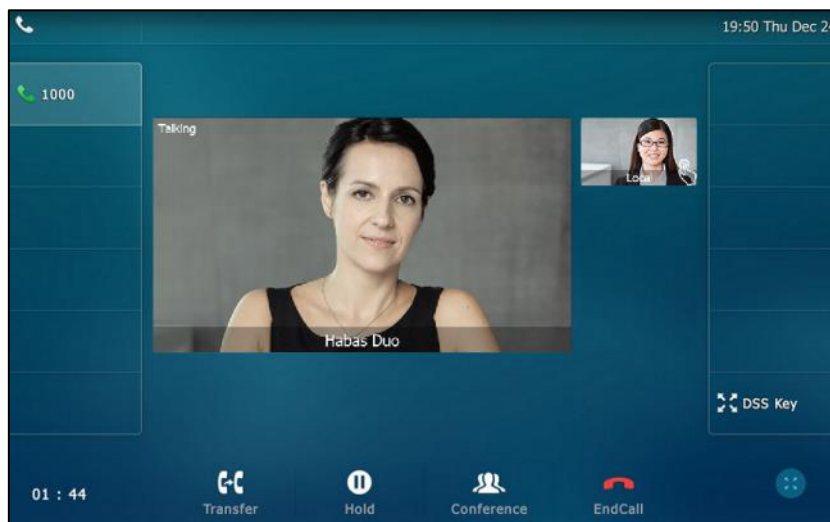

The near-site video will display in the center of the touch screen, and the far-site video will display on the top-right of the touch screen.

The following figure shows what the touch screen looks like after you tap the near-site video:

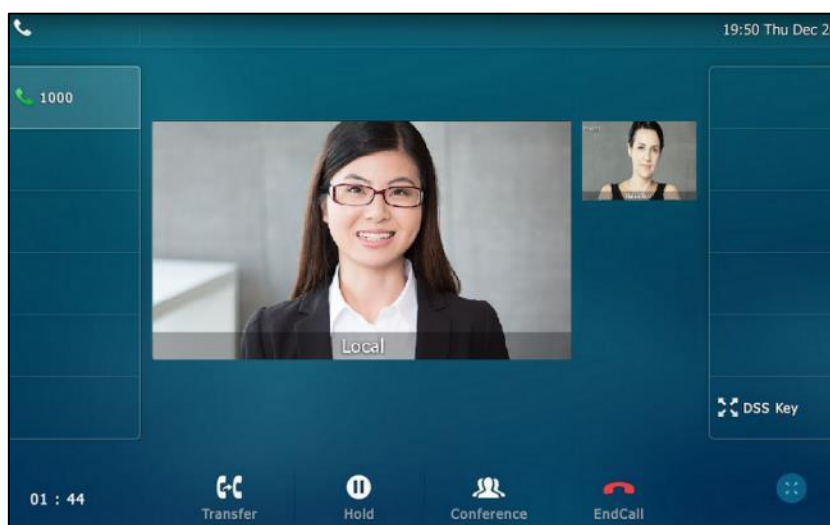

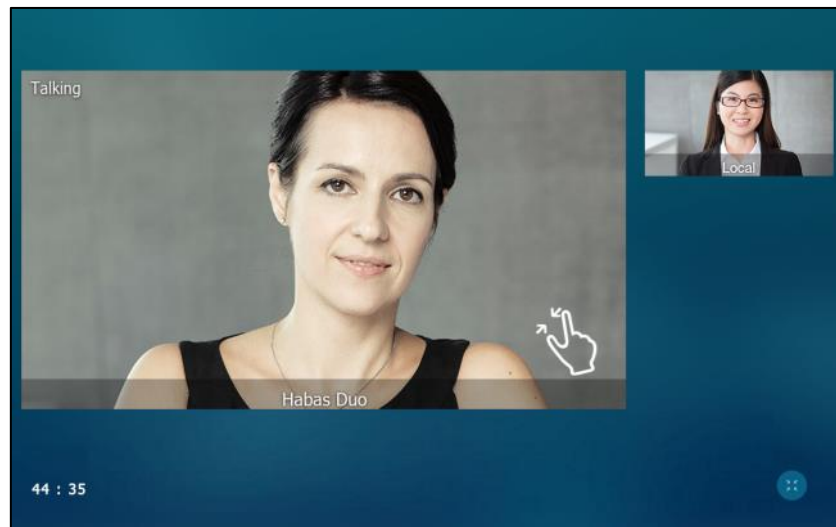

To change the video layout to the same size mode during a video call via phone user interface:

1. From the video call full-screen, pinch close the large window.

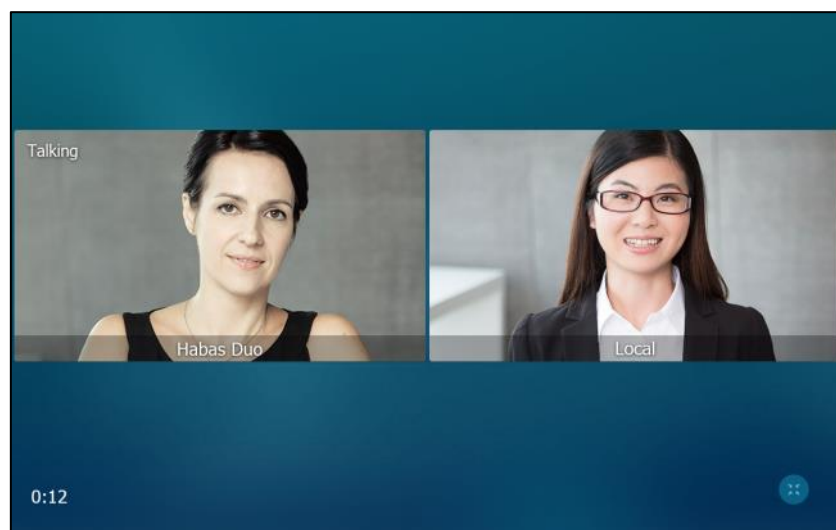

The following figure shows what the touch screen looks like in the same size mode:



You can tap  to go to video call screen (refer to [Video Call Screen Display](#)) or tap the desired image to go back to “one big, other small” layout.

To change the video layout to the full screen mode during a video call via phone user interface:

1. From the video call full-screen, do one of the following:
 - Tap the large window.

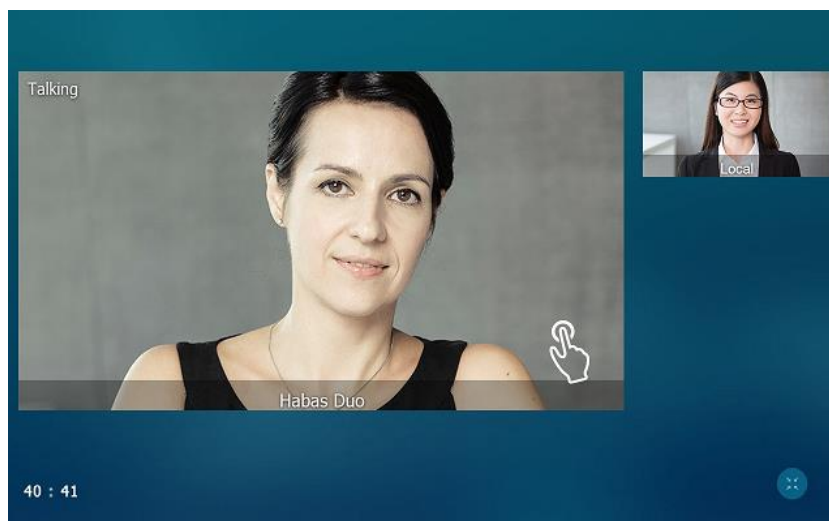

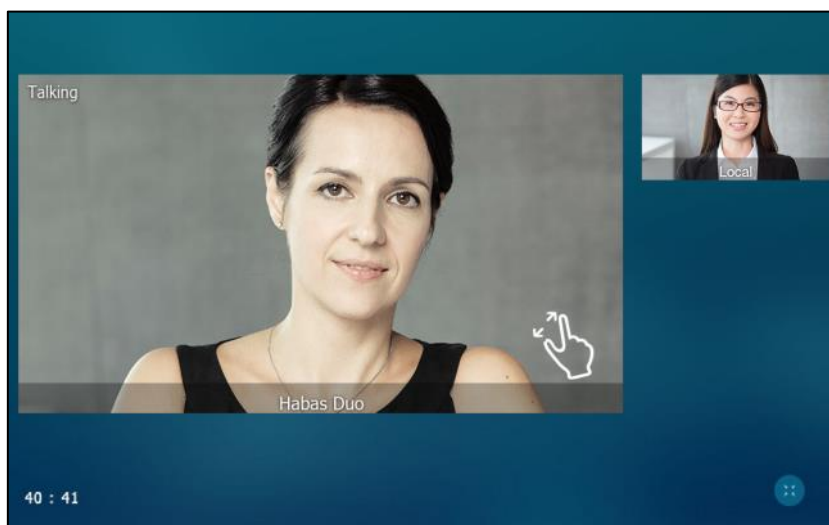

- Pinch open the large window.

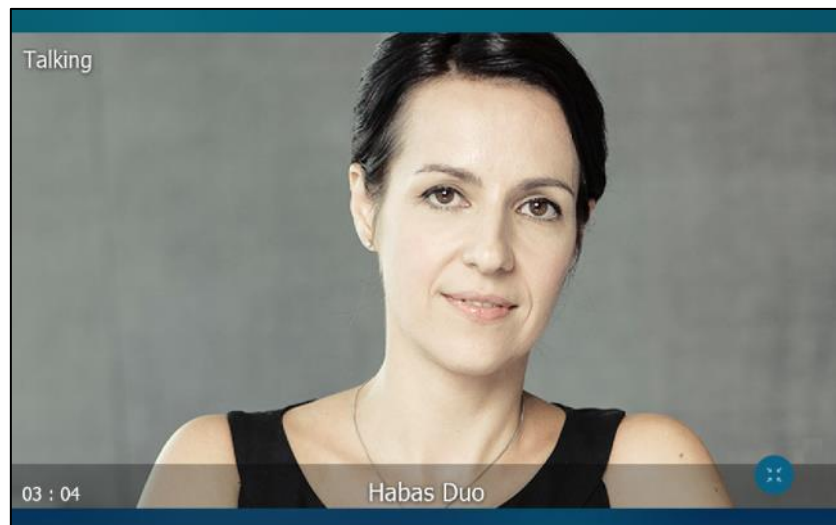

The small window is hidden.

The following figure shows what the touch screen looks like in full screen mode:



You can tap  to go to video call screen (refer to [Video Call Screen Display](#)) or tap the video area to go back to “one big, other small” layout.

To change the video layout during a video conference call via phone user interface:

The default screen layout during a video conference call is the same size mode. The following figure shows what the touch screen looks like during a three-way video conference call:

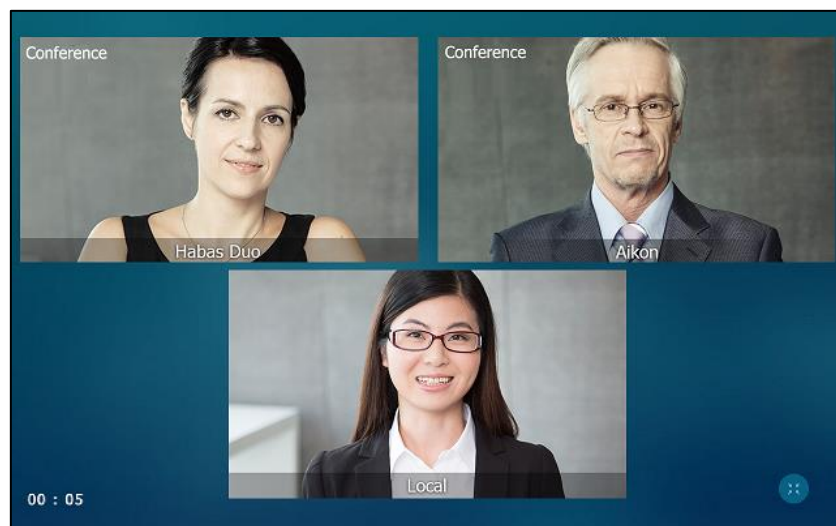

You can tap  to go to video call screen (refer to [Video Call Screen Display](#)) or tap one of the conference party to go back to the “one big, other small” layout.

The following figure shows what the touch screen looks like in the “one big, other small” layout during a three-way video conference call:

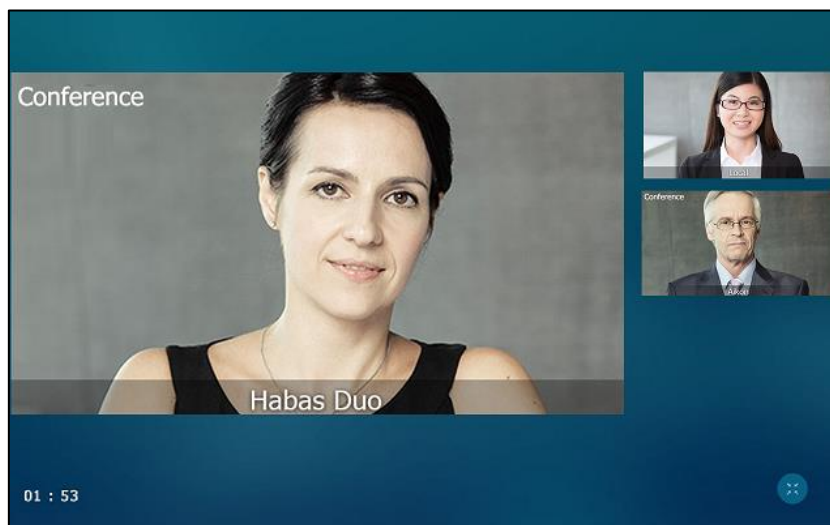

Previewing the Near-Site Video

You can preview the video of yourself that you display during video calls, and configure the scene mode at the same time.

To preview the near-site video when the phone is idle, do one of the following:

- Press  .
- Swipe down from the top of the screen to enter the control center and tap **Video**.

To configure the scene mode when previewing near-site video:

1. Tap **Standard Mode**.
2. Tap the desired item in the pop-up dialog box.

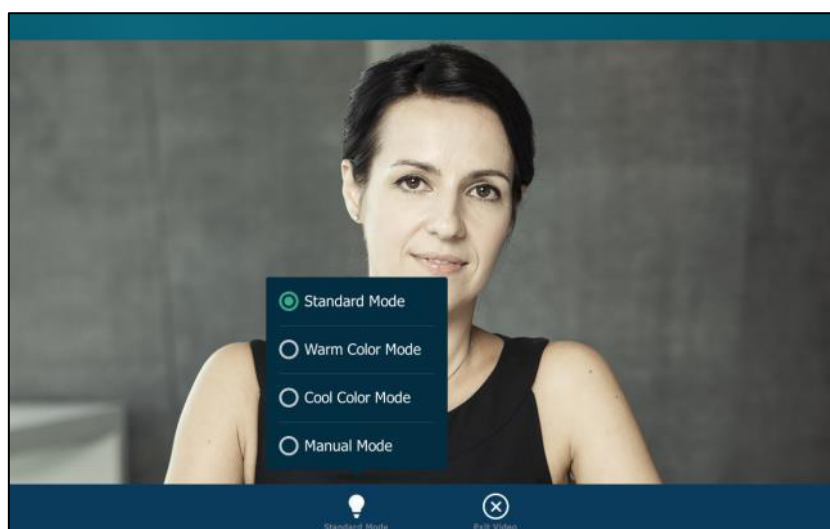

If you select **Manual Mode**, the settings you have configured at the path

 -> **Basic->Camera Setting->Scene Mode** will be applied. For more information, refer to [Scene Mode](#) on page 162.

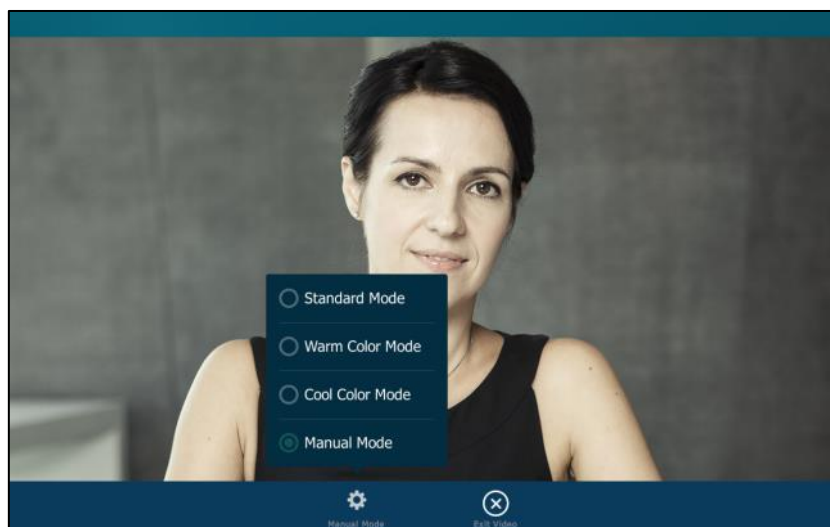

3. Press  or tap **Exit Video** to return to the idle screen.

Note

The soft keys (**Standard Mode** and **Exit Video**) are hidden after they display 5 seconds, unless you tap the touch screen.

External Monitor

During a video call, the video image captured from the camera (both near site and far site) will be also shown on the external monitor. You can have a clearer view of the far-site video image on the external monitor. To display video image on the external monitor, you have to enable EXT Display feature on the phone.

The following figure shows an example of phone and external monitor screens display during a video call:



If you change the video layout on the IP phone, the content displayed on the external

monitor will change as well. If the phone is not in a video call, the external monitor will display a Yealink logo.

Before using the external monitor, ensure that the external monitor has been connected to your phone. For more information, refer to [Phone Installation](#) on page 29.

Note

The Extended Display Accessories ED10 is required for connecting the external monitor. You should purchase it separately. For more information, refer to [Yealink Extended Display Accessories Quick Installation Guide for SIP VP-T49G](#).

SIP VP-T49G IP phone supports the following video resolutions on both IP phone and external monitor:

Scenario	Resolution	
	Receive	Send
Single channel video calls	1920 x 1080 (1080P)	1920 x 1080 (1080P)
One to many single channel video calls	1920 x 1080 (1080P)	1920 x 1080 (1080P)
3-way video conference	704 x 576 (4CIF)	1280 x 720 (720P)

To enable the external monitor via phone user interface, do one of the following:

- Tap  -> **Basic**-> **HDMI**.
Tap the **EXT Display** field.
Tap **Enabled** in the pop-up dialog box.
Tap the **Save** soft key.
- Swipe down from the top of the screen to enter the control center and toggle **EXT Display** on.

The EXT Display icon  will display on the status bar of the touch screen.





Note

If you connect the external monitor, but disable the EXT Display, the external monitor will not display the content on the phone but a Yealink logo.

To disable the external monitor via phone user interface, do one of the following:

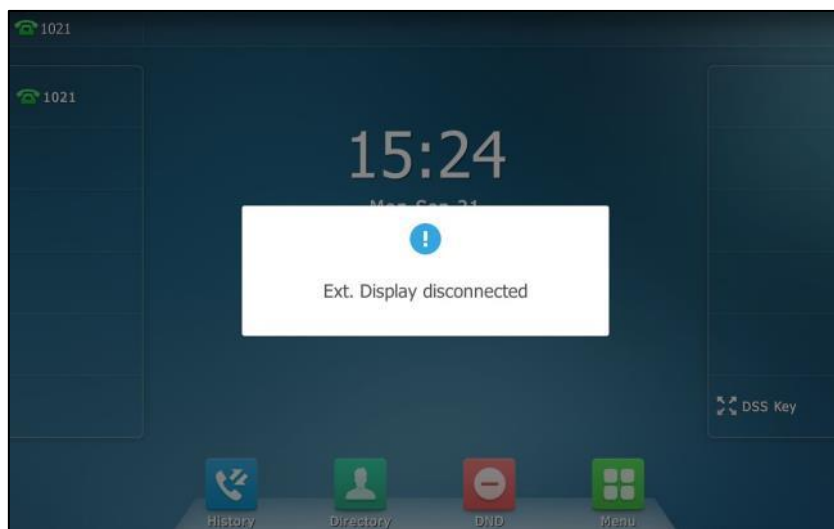
- Disconnect the monitor.
The touch screen prompts "Ext. Display disconnected".



- Tap  -> **Basic**->**HDMI**.
Tap the **EXT Display** field.
Tap **Disabled** in the pop-up dialog box.
Tap the **Save** soft key.
- Swipe down from the top of the screen to enter the control center and toggle **EXT Display** off.

Redialing Numbers

To redial the last dialed number from your phone:

1. Press  twice.
2. A call to your last dialed number is attempted.

To redial a previously dialed number from your phone:

1. Press  when the phone is idle.
2. Tap the desired entry from the placed calls list.

Recent Call In Dialing

To view the placed calls list when the phone is on the dialing interface, you should enable recent call in dialing in advance.

To enable recent call in dialing via web user interface:

1. Click on **Directory->Setting**.
2. Select **Enabled** from the pull-down list of **Recent Call In Dialing**.

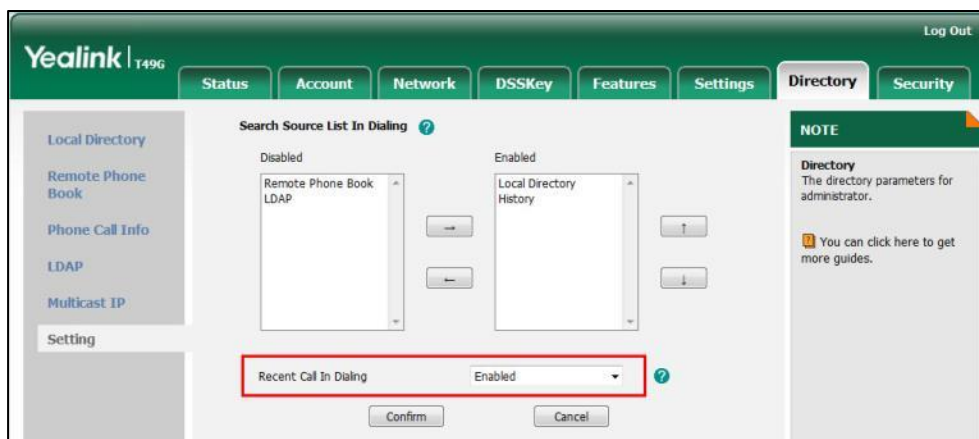

3. Click **Confirm** to accept the change.

Note

Recent call in dialing is configurable via web user interface only.

To view placed calls list when the phone is on the dialing interface:

1. Pick up the handset, press the Speakerphone key or tap the line key.

The touch screen displays the placed calls list.

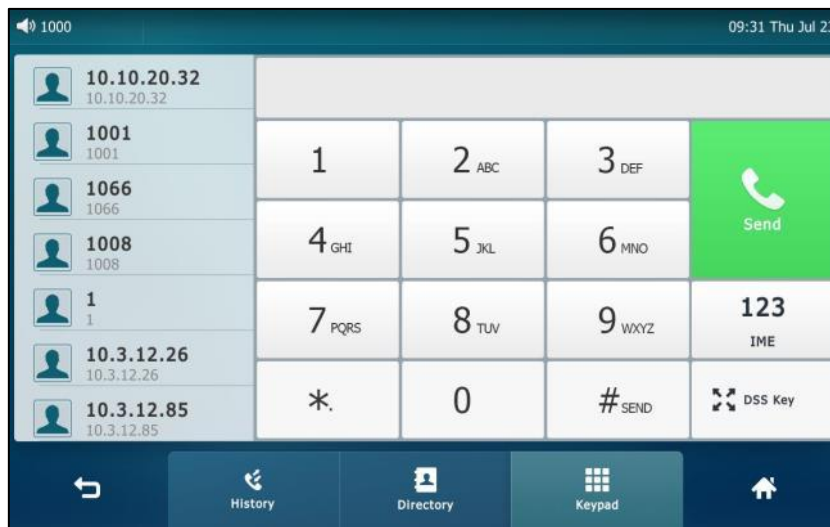

2. Drag up and down to scroll through placed calls.

You can also enter a few continuous characters of the contact name or continuous numbers of the contact number (office, mobile or other number) to search from placed calls list.

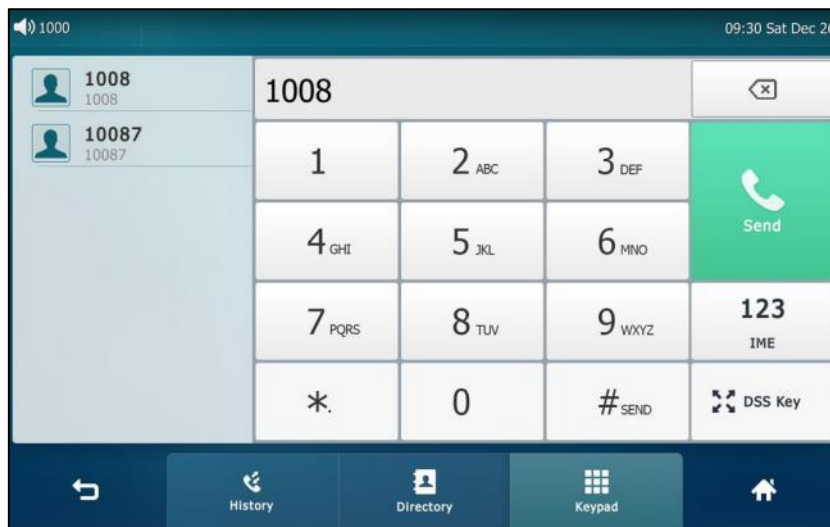

Auto Answer

You can use auto answer to automatically answer an incoming call on a line. Auto answer is configurable on a per-line basis.

To configure auto answer via phone user interface:

1. Tap  -> Features->Auto Answer.

2. Tap the **On** radio box in the desired line.



3. Tap the **Save** soft key to accept the change or to cancel. The icon will display on the status bar of the touch screen.

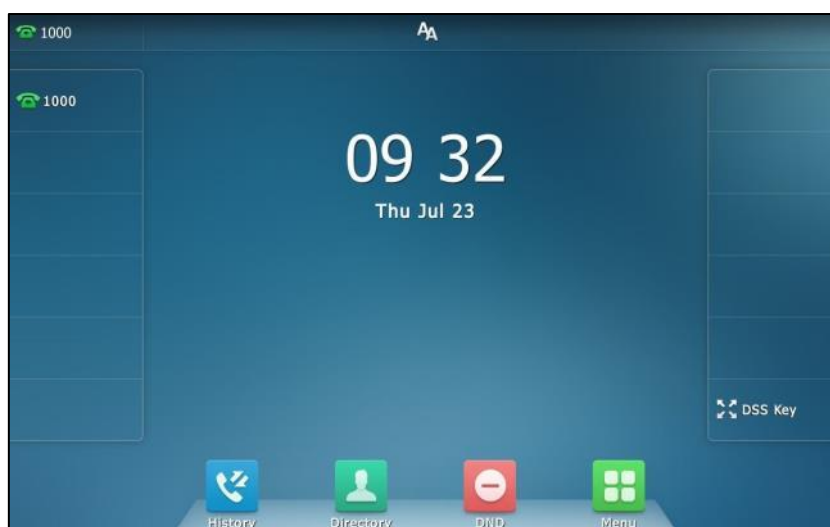

You can also swipe down from the top of the screen to enter the control center, tap **Auto Answer** to turn to the Auto Answer setting screen, and then enable auto answer feature for the desired line.

Auto answer is configurable via web user interface at the path **Account->Basic**.

Note Auto answer is only applicable when there is no other call in progress on the phone.

Auto Redial

You can enable auto redial to automatically redial a phone number when the called party is busy. You can also configure the number of auto redial attempts and the time to wait between redial attempts.

To configure auto redial via phone user interface:

1. Tap  -> **Features**->**Auto Redial**.
2. Tap the **On** radio box in the **Auto Redial** field.
3. Enter the desired time (in seconds) in the **Redial Interval** field.
The default value is "10".
4. Enter the desired number of redial attempts in the **Redial Times** field.
The default value is "10".

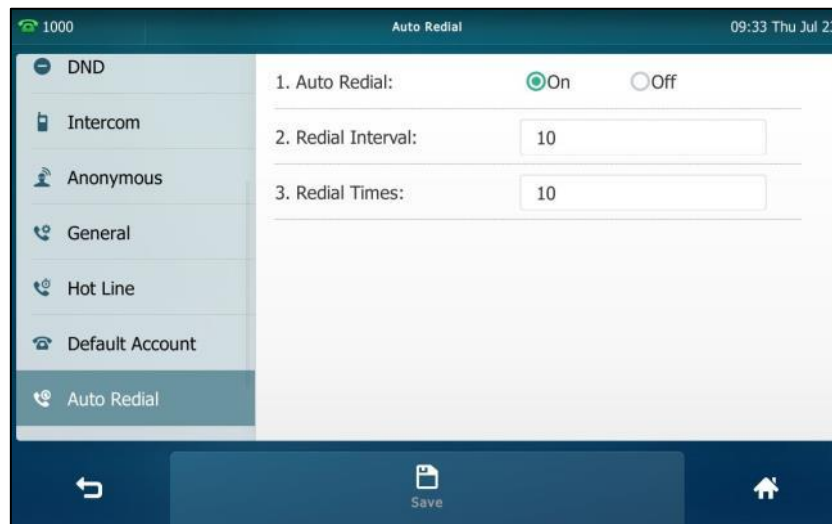

5. Tap the **Save** soft key to accept the change or  to cancel.

Auto redial is configurable via web user interface at the path **Features**->**General Information**.

To use auto redial:

When the called party is busy, the touch screen prompts the following:

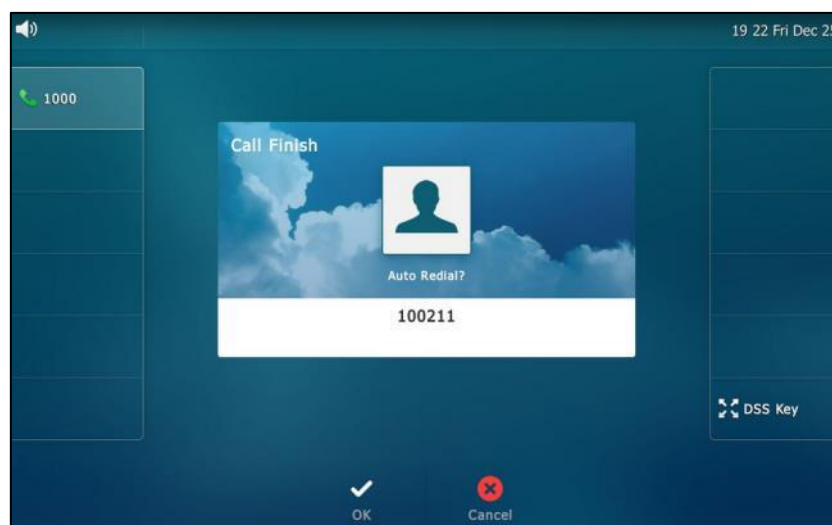

1. Tap **OK** to activate auto redial.

The touch screen prompts the following:

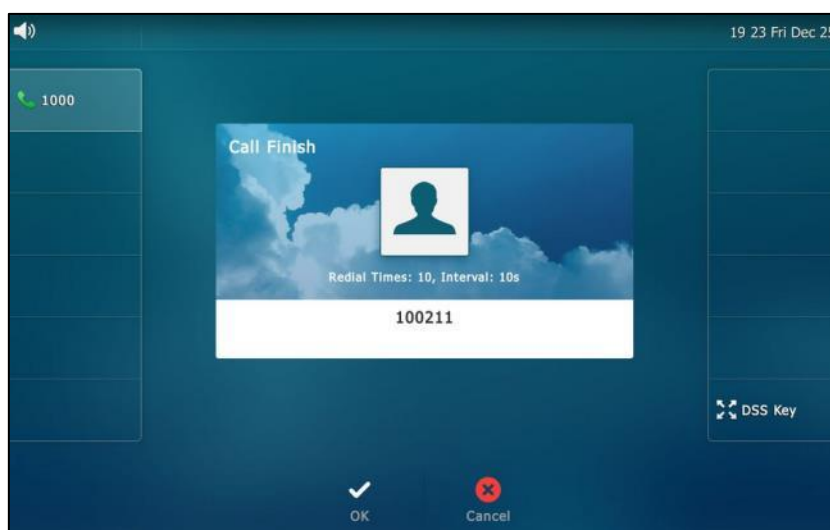

2. Wait for the designated period of time or tap **OK** to redial the phone number. The phone will retry as many times as configured until the called party is idle.

Call Completion

You can use call completion to notify the caller who failed to reach a desired party when the party becomes available to receive a call.

To enable call completion via phone user interface:

1. Tap  -> **Features**->**Call Completion**.
2. Tap the **On** radio box in the **Call Completion** field.

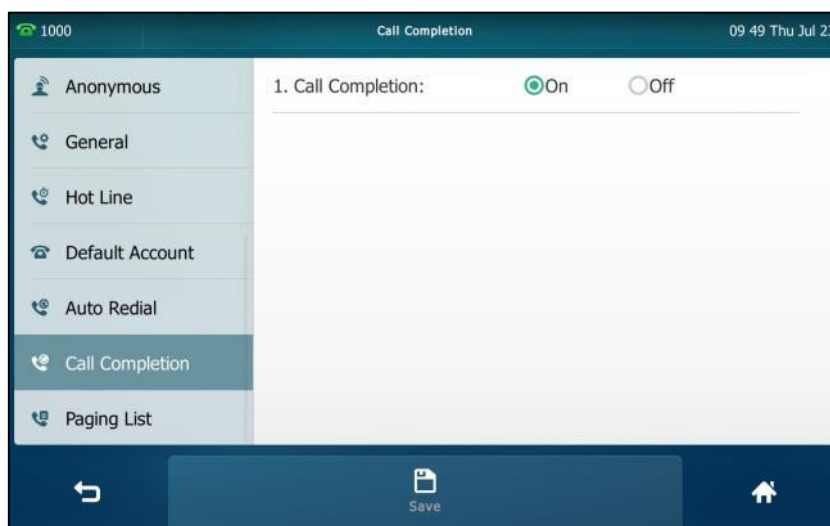

3. Tap the **Save** soft key to accept the change or  to cancel.

Call completion is configurable via web user interface at the path **Features**->**General Information**.

To use call completion:

When the called party is busy, the following prompt will appear on the touch screen of the phone:

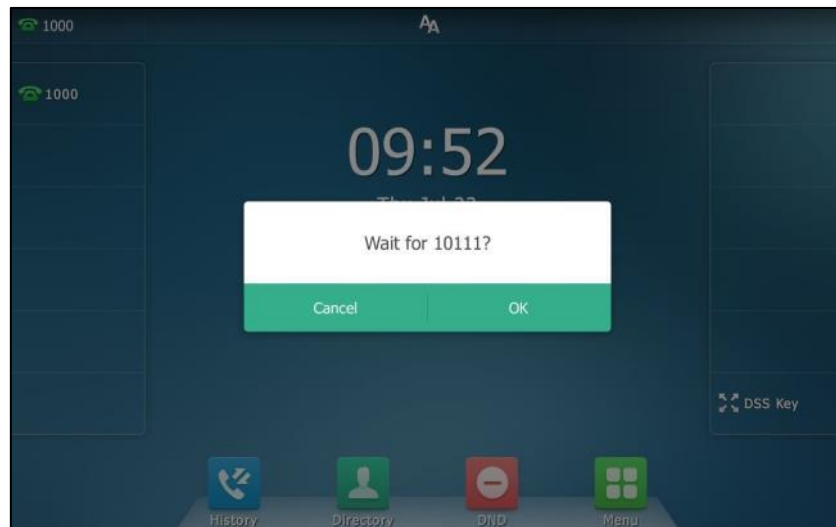

1. Tap **OK**, the phone will then return to the idle screen and call completion will be activated.

When the called party becomes idle, the touch screen prompts the following:

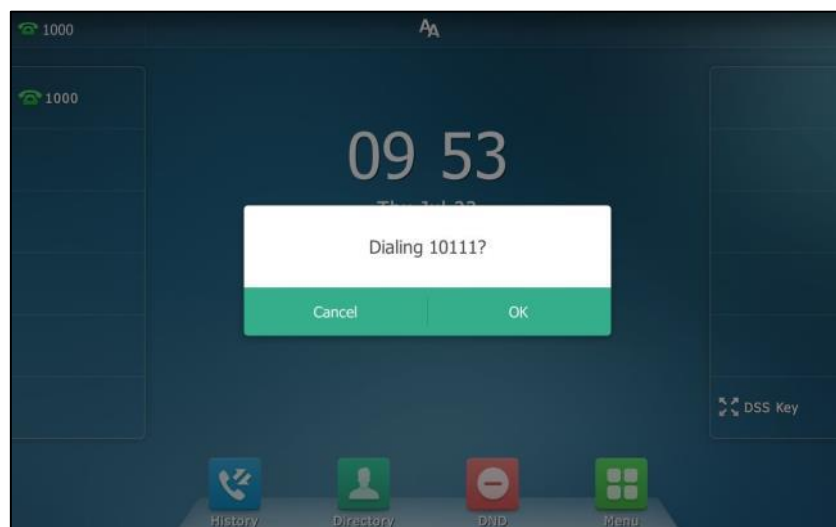

1. Tap **OK** to redial the number.

Note

Call completion is not available on all servers. For more information, contact your system administrator.

Recall

You can tap a recall key to place a call back to the last incoming call.

To configure a recall key via phone user interface:

1. Tap  -> **Features**-> **DSS Keys**.
2. Tap the desired line key.
3. Tap the **Type** field.
4. Tap **Key Event** in the pop-up dialog box.
5. Tap the **Key Type** field.
6. Tap **ReCall** in the pop-up dialog box.
7. (Optional.) Enter the string that will appear on the touch screen in the **Label** field.

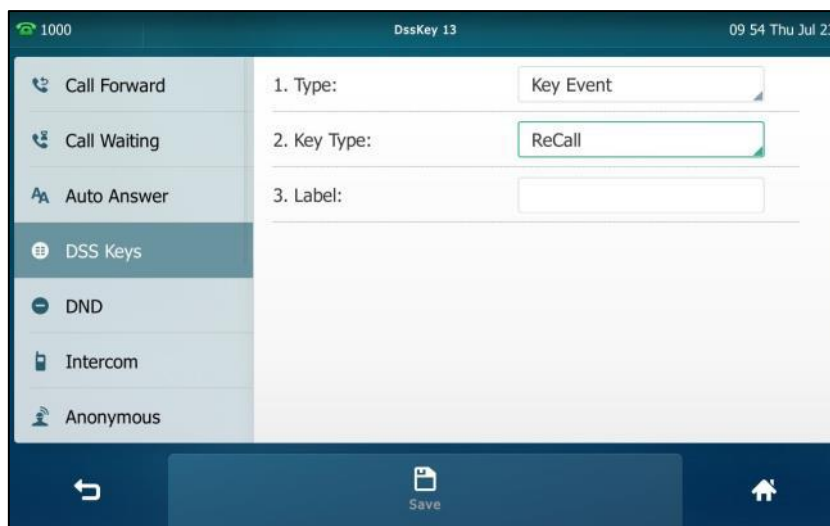

8. Tap the **Save** soft key to accept the change or  to cancel.

Recall key is configurable via web user interface at the path **DSSKey->Line key**. You can also tap **DSS Key** on the idle screen to configure a recall key.

Call Mute

You can mute the microphone of the active audio device during an active call so that the other party cannot hear you. Call mute applies to all modes (Handset, Headset and Speakerphone).

To mute a call:

1. Press  during an active call.

The touch screen indicates that the call is muted. The mute key LED illuminates solid red when the call is muted.

The following shows an audio-only call has been muted:

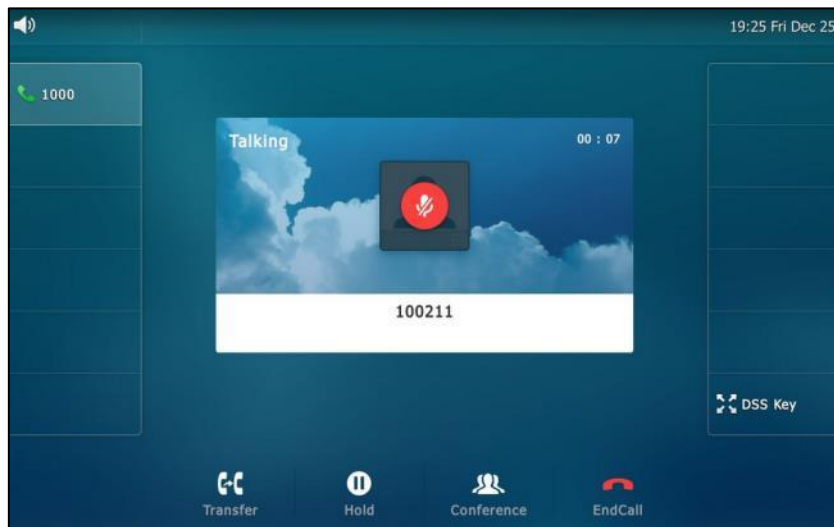

The following shows a video call has been muted:

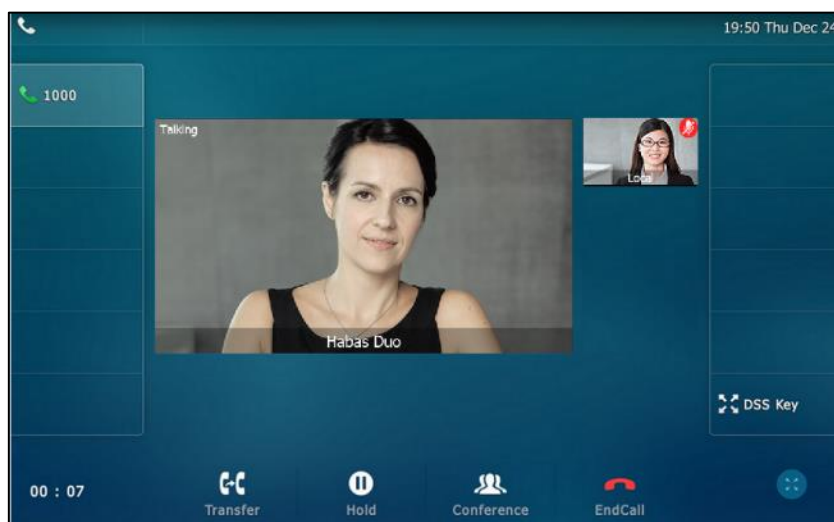

To un-mute a call:

1. Press  again to un-mute the call.

Call Hold/Resume

You can place an active call on hold. Only one active call can be in progress on the phone at any time. Other calls can be made and received while placing the original call on hold. When you place a call on hold, your IP PBX may play music to the other party while waiting.

To place a call on hold:

1. Press  or tap the **Hold** soft key during a call.

The following shows an audio-only call has been held:

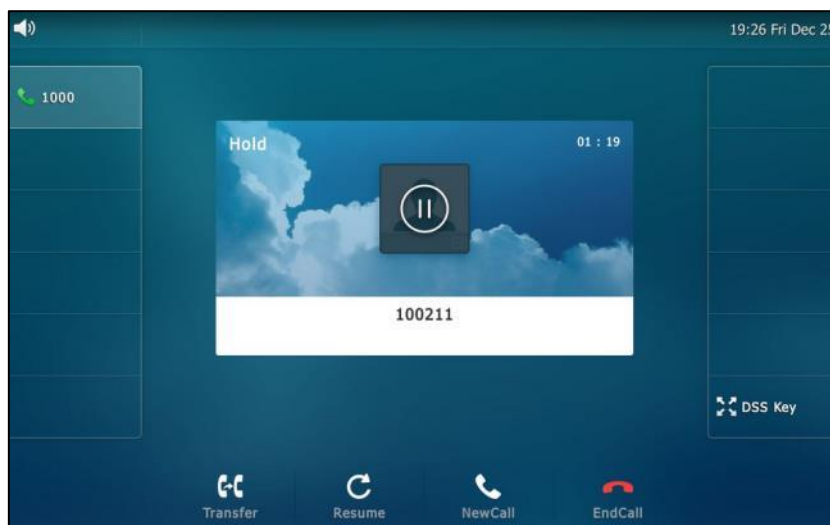

The following shows a video call has been hold:

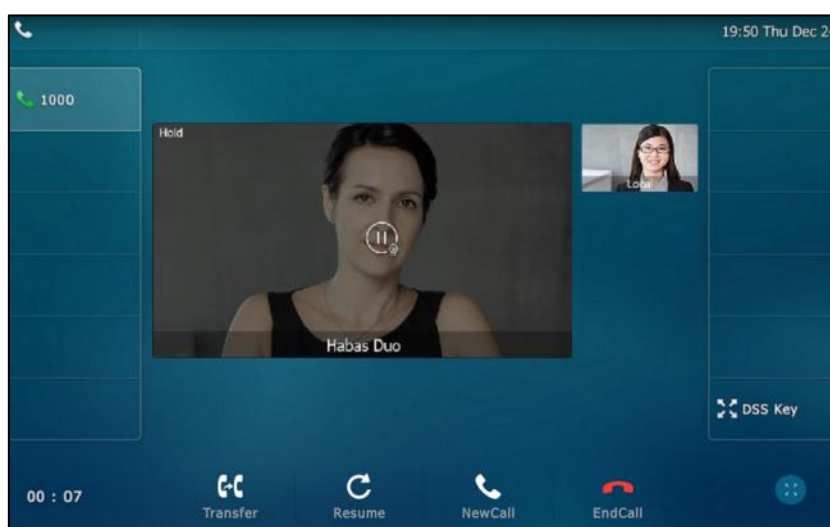

The phone will beep softly every 30 seconds to remind you that you still have a call on hold.

To resume a held call:

1. Press  or tap the **Resume** soft key.

Multiple Calls on Hold:

If multiple calls are placed on hold, do one of the following:

- Tap the desired call, and then tap the **Resume** soft key to retrieve it.
- Tap the desired call, and then tap the corresponding line key to retrieve it.

Do Not Disturb (DND)

You can use DND to reject incoming calls automatically on the phone. The prompt message "**n New Missed Call(s)**" ("n" indicates the number of missed calls) will appear on the touch screen, and callers will receive a busy message. All calls you receive while DND is enabled are logged to your missed calls list.

Note

The prompt message will display only if Missed Call Log for the line is enabled. Missed call log is configurable via web user interface at the path **Account->Basic->Missed Call Log**.

Do not disturb is local to the phone, and may be overridden by the server settings. For more information, contact your system administrator.

You can enable/disable DND for the phone system, or you can customize DND for each or all accounts. Two DND modes:

- **Phone** (default): DND is effective for the phone system.
- **Custom**: DND can be configured for each or all accounts.

You can receive incoming calls from authorized numbers when DND is enabled.

To configure the DND mode via web user interface:

1. Click on **Features->Forward & DND**.
2. In the **DND** block, mark the desired radio box in the **Mode** field.

The screenshot shows the Yealink T49G web user interface. The top navigation bar includes 'Status', 'Account', 'Network', 'DSSKey', 'Features', 'Settings', 'Directory', and 'Security'. The 'Features' tab is selected, and the 'Forward&DND' section is active. The 'Forward' section includes 'Forward Emergency' (Disabled), 'Forward Authorized Numbers', 'Mode' (Phone selected), 'Account' (1000), and 'Always Forward' (Off). The 'DND' section includes 'DND Emergency' (Disabled), 'DND Authorized Numbers', 'Mode' (Phone selected), 'Account' (1000), 'DND Status' (On), 'DND On Code', and 'DND Off Code'. A red box highlights the 'Mode' field in the DND section. A 'NOTE' box on the right provides information about the Forward feature.

3. Click **Confirm** to accept the change.

Note

DND mode is configurable via web user interface only.

To activate DND in phone mode:

1. Do one of the following:

- Tap  .
- Swipe down from the top of the screen to enter the control center and toggle **DND** on.

The icon  on the status bar indicates that DND is enabled.

Incoming calls will be rejected automatically and "**n New Missed Call(s)**" ("n" indicates the number of missed calls. e.g., 1 New Missed Call(s)) will appear on the touch screen.

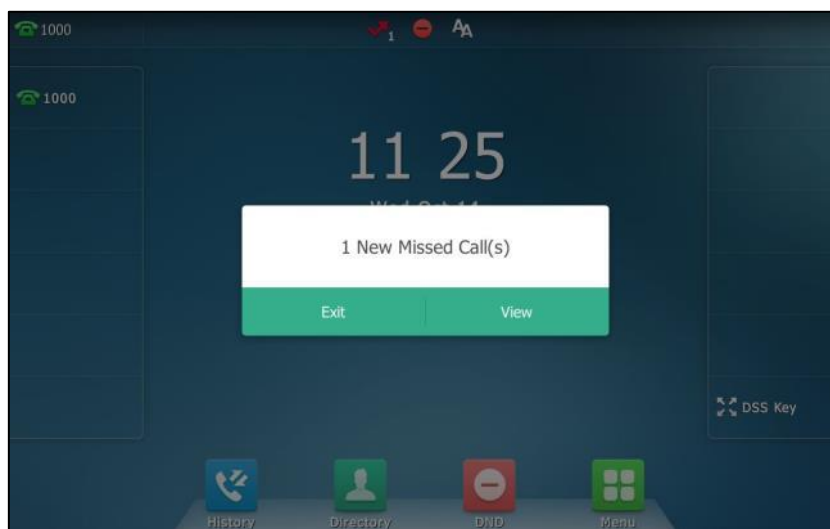

Note

When DND and busy forward are enabled in phone mode, all incoming calls will be forwarded to the configured destination number. For more information on busy forward, refer to [Call Forward](#) on page 192.

To activate DND in custom mode for a specific account:

1. Do one of the following:

- Tap  .
- Swipe down from the top of the screen to enter the control center and then tap **DND**.

The touch screen displays a list of accounts registered on the phone.

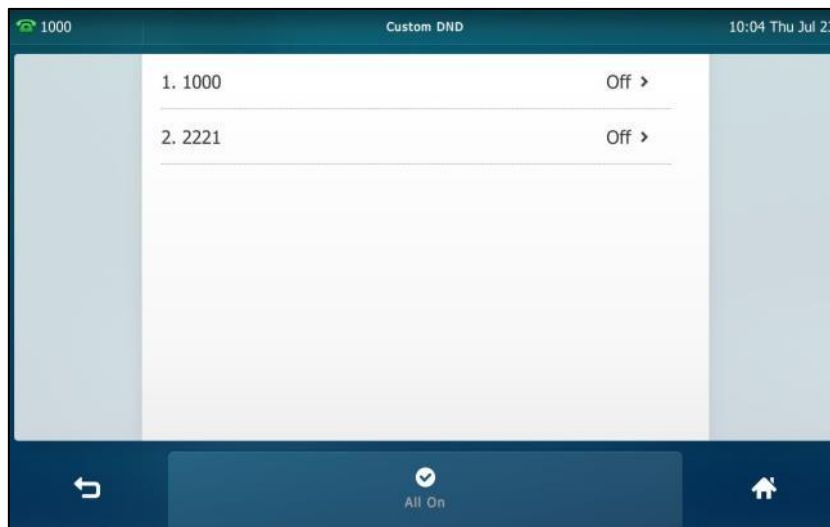

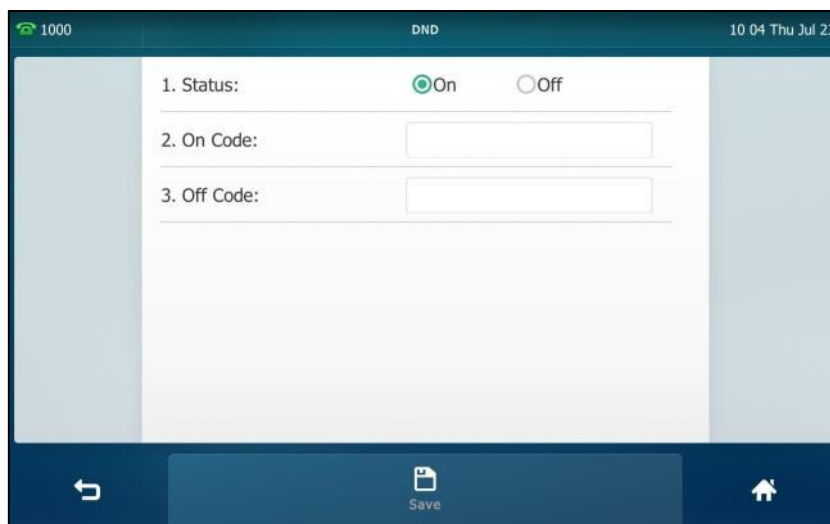

2. Tap the desired account.
3. Tap the **On** radio box in the **Status** field.





4. Tap the **Save** soft key to accept the change.

If you activate DND for the default account, the associated line icon will change to

 , and the icon  will appear on the status bar.

If you activate DND for the non-default account, only the associated line icon will

change to  , the icon  will not appear on the status bar.

Incoming calls on the specific line will be rejected automatically, and the touch screen will prompt "**n New Missed Call(s)**" ("n" indicates the number of missed calls. e.g., 2 New Missed Call(s)).

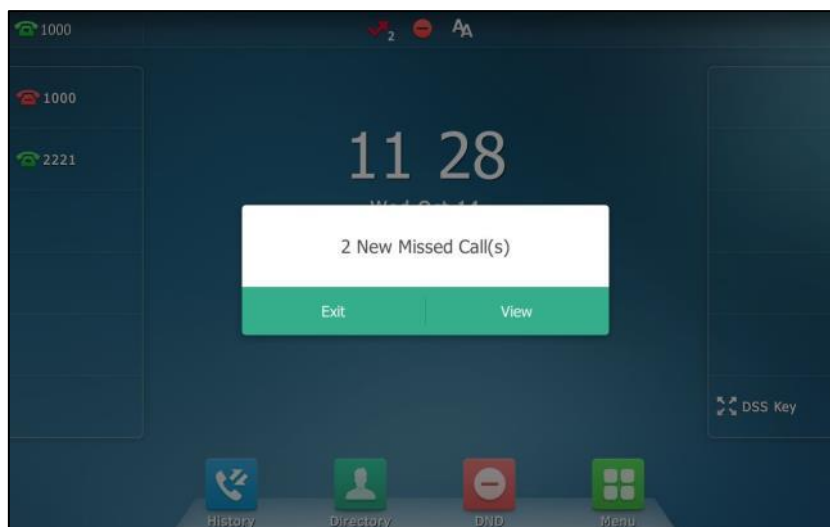

Note When DND and busy forward are enabled for a specific account, incoming calls on the specific account will be forwarded to the configured destination number. For more information on busy forward, refer to [Call Forward](#) on page 192.

To activate DND in custom mode for all accounts:

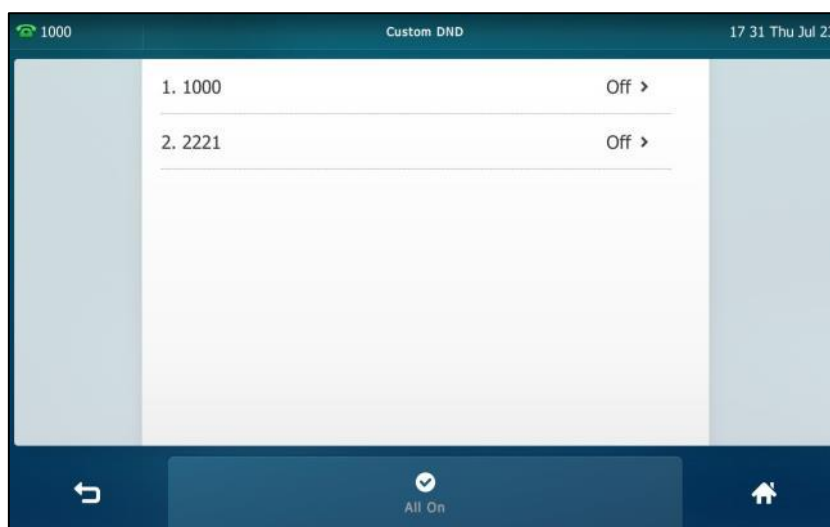

1. Do one of the following:
 - Tap  .
 - Swipe down from the top of the screen to enter the control center and then tap **DND**.

The touch screen displays a list of accounts registered on the phone.



2. Tap the **All On** soft key to activate DND for all accounts.

- Tap  to return to the idle screen.

The icon  appears on the status bar, and all line icons change to .

Incoming calls will be rejected automatically, and the touch screen will prompt "**n New Missed Call(s)**" ("n" indicates the number of the missed calls. e.g., 1 New Missed Call(s)).

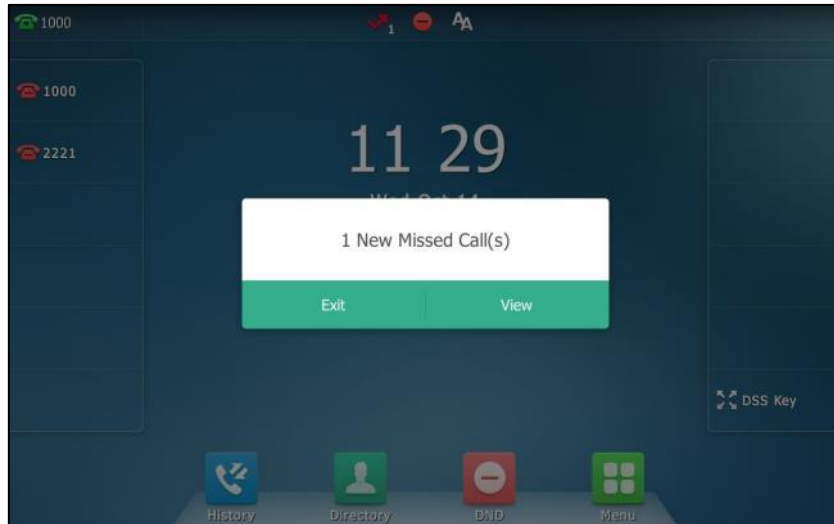

To configure the DND authorized numbers via web user interface:

- Click on **Features->Forward & DND**.
- Select **Enabled** from the pull-down list of **DND Emergency**.
- Enter the numbers in the **DND Authorized Numbers** field.

For multiple numbers, enter a comma between every two numbers.

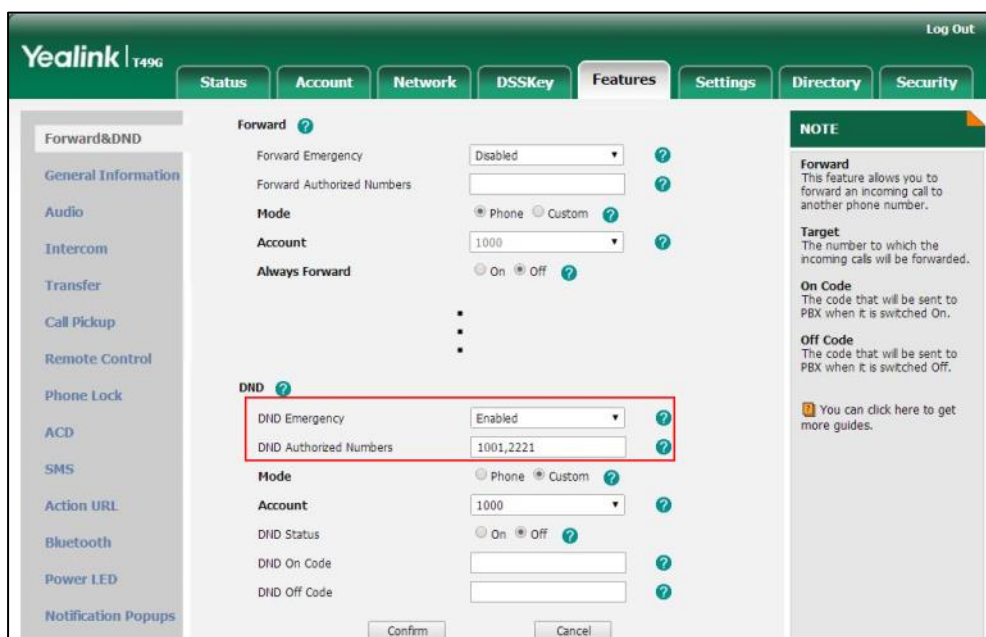

- Click **Confirm** to accept the change.

When DND is enabled on the phone, the phone can still receive incoming calls from the

numbers specified in the **DND Authorized Numbers** field.

Note DND authorized number is configurable via web user interface only.

Call Forward

You can configure your phone to forward incoming calls to another party through the static forwarding. You can also forward calls while your phone is ringing; refer to the Dynamic Forwarding.

You can forward an incoming call to an international telephone number. This feature is enabled by default. Incoming calls from some authorized numbers not to be forwarded when the call forward feature is enabled. The incoming call will not be logged in the Forwarded Calls list. This feature is disabled by default.

Note Call forward is local to the phone, and may be overridden by the server settings. For more information, contact your system administrator.
If DND feature is enabled, the incoming calls will not be forwarded even if you configure no answer forward feature.

Static Forwarding

Three types of static forwarding:

- **Always Forward:** Incoming calls are immediately forwarded.
- **Busy Forward:** Incoming calls are immediately forwarded if the phone is busy.
- **No Answer Forward:** Incoming calls are forwarded if not answered after a period of time.

You can enable/disable call forward for the phone system, or you can customize call forward for each or all accounts. Two call forward modes:

- **Phone (default):** Call forward is effective for the phone system.
- **Custom:** Call forward can be configured for each or all accounts.

To configure the call forward mode via web user interface:

1. Click on **Features->Forward & DND**.

- In the **Forward** block, mark the desired radio box in the **Mode** field.

The screenshot shows the Yealink T49G web interface. The 'Forward' configuration page is active. The 'Mode' field is highlighted with a red box, showing 'Phone' selected and 'Custom' unselected. Other fields include Forward Emergency (Disabled), Forward Authorized Numbers, Account (1000), Always Forward (Off), Busy Forward (Off), and No Answer Forward (Off). A 'NOTE' section on the right explains the Forward feature and provides details for Target, On Code, and Off Code.

- Click **Confirm** to accept the change.

Note

Call forward mode is configurable via web user interface only.

To enable call forward in phone mode:

- Tap  -> **Features**-> **Call Forward**.
- Tap the desired forwarding type.
- Depending on your selection:
 - If you tap **Always Forward**:
 - Tap the **On** radio box in the **Always Forward** field.
 - Enter the destination number you want to forward all incoming calls to in the **Forward To** field.
 - (Optional.) Enter the always forward on code or off code respectively in the **On Code** or **Off Code** field.

The screenshot shows the mobile app interface for 'Always Forward'. The screen displays four fields: 1. Always Forward: On (selected), 2. Forward To: 2003, 3. On Code: *71, 4. Off Code: *72. A 'Save' button is visible at the bottom.

b) If you tap **Busy Forward**:

- 1) Tap the **On** radio box in the **Busy Forward** field.
- 2) Enter the destination number you want to forward incoming calls to when the phone is busy in the **Forward To** field.
- 3) (Optional.) Enter the busy forward on code or off code respectively in the **On Code** or **Off Code** field.

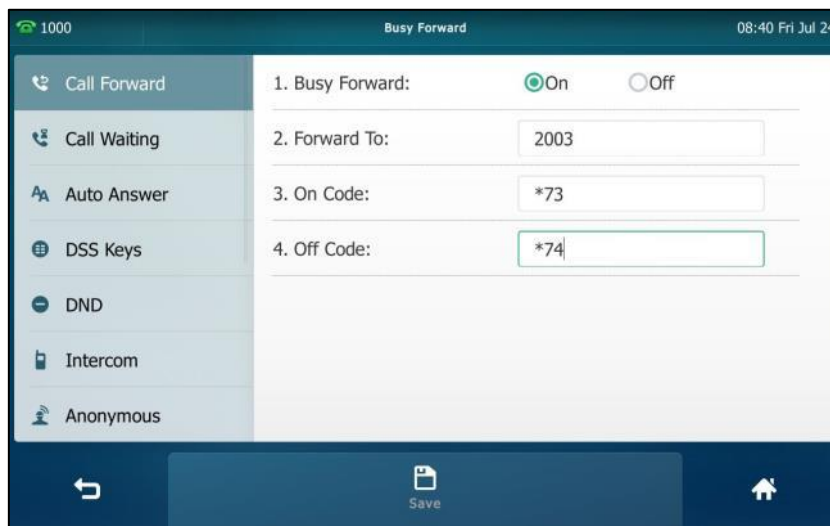

c) If you tap **No Answer Forward**:

- 1) Tap the **On** radio box in the **No Answer Forward** field.
- 2) Enter the destination number you want to forward unanswered incoming calls to in the **Forward To** field.
- 3) Tap the **After Ring Time** field.
- 4) Tap the desired ring time to wait before forwarding from the pull-down list. The default ring time is 12 seconds.
- 5) (Optional.) Enter the no answer forward on code or off code respectively in the **On Code** or **Off Code** field.

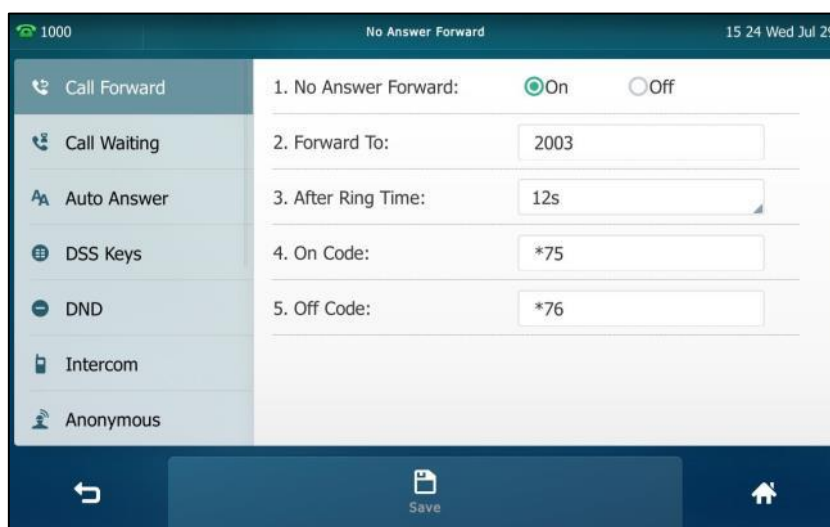



4. Tap the **Save** soft key to accept the change or  to cancel.

The icon  on the status bar indicates that the call forward is enabled.

You can also swipe down from the top of the screen to enter the control center, tap **FWD** to turn to the desired call forward setting screen according to the current forward type. If you have not configured the call forward type, tapping **FWD** will turn to the Always Forward setting screen.

To enable call forward in custom mode:

1. Do one of the following:
 - Tap  -> **Features**-> **Call Forward**.
 - Press  when the phone is idle.
 - Swipe down from the top of the screen to enter the control center and then tap **FWD**.
2. Tap the desired account.

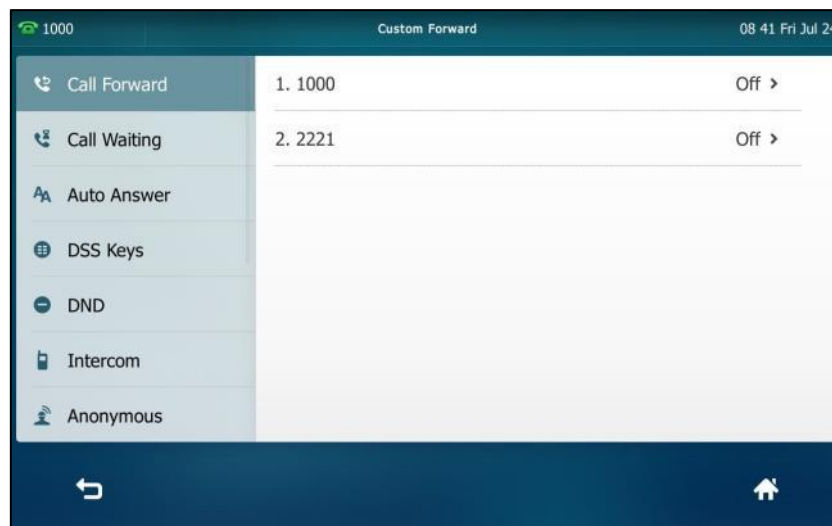

3. Tap the desired forwarding type.
4. Depending on your selection:
 - a) If you tap **Always Forward**:
 - 1) Tap the **On** radio box in the **Always Forward** field.
 - 2) Enter the destination number you want to forward all incoming calls to in the **Forward To** field.

- 3) (Optional.) Enter the always forward on code or off code respectively in the **On Code** or **Off Code** field.

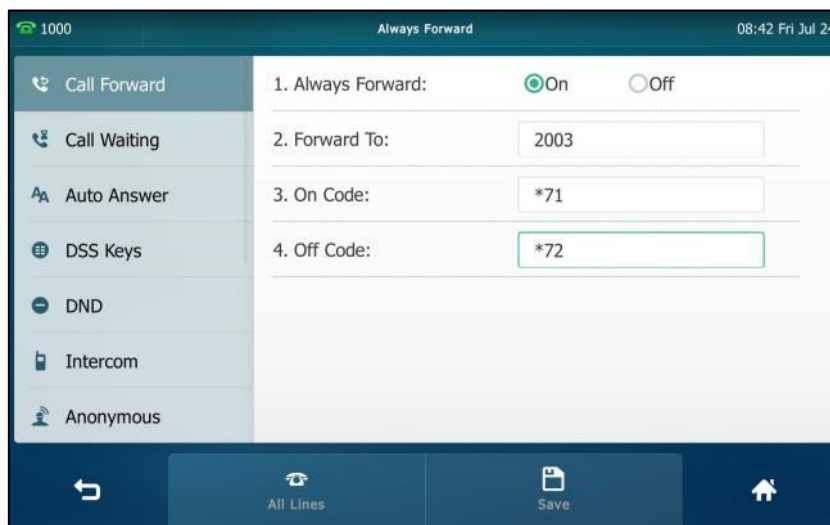

You can also enable always forward for all accounts. Do the following:

- 1) Tap the **All Lines** soft key.

The touch screen prompts “Copy to all lines?”.

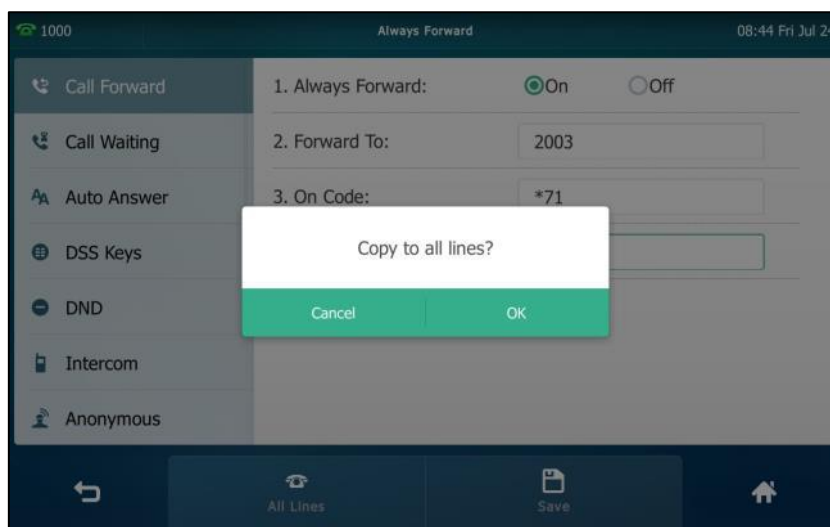

- 2) Tap **OK** to accept the change or **Cancel** to cancel.

b) If you select **Busy Forward**:

- 1) Tap the **On** radio box in the **Busy Forward** field.
- 2) Enter the destination number you want to forward incoming calls to when the phone is busy in the **Forward To** field.

- 3) (Optional.) Enter the busy forward on code or off code respectively in the **On Code** or **Off Code** field.

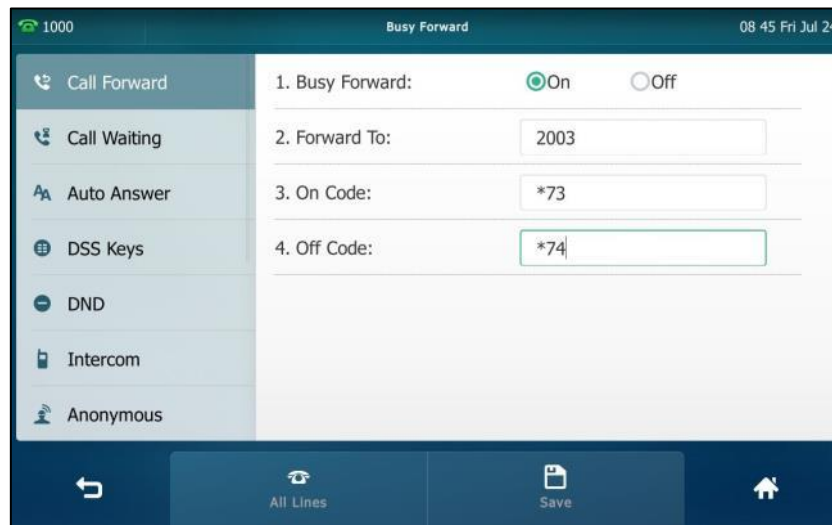

You can also enable busy forward for all accounts. Do the following:

- 1) Tap the **All Lines** soft key.

The touch screen prompts “Copy to all lines?”.

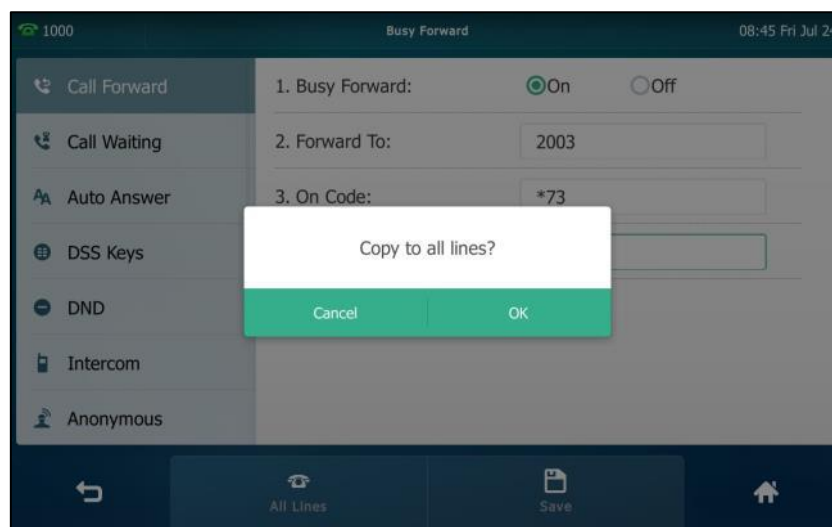

- 2) Tap **OK** to accept the change or **Cancel** to cancel.
- c) If you select **No Answer Forward**:
- 1) Tap the **On** radio box in the **No Answer Forward** field.
 - 2) Enter the destination number you want to forward unanswered incoming calls to in the **Forward To** field.
 - 3) Tap the **After Ring Time** field.
 - 4) Tap the desired ring time to wait before forwarding from the pull-down list. The default ring time is 12 seconds.
 - 5) (Optional.) Enter the no answer forward on code or off code respectively

in the **On Code** or **Off Code** field.

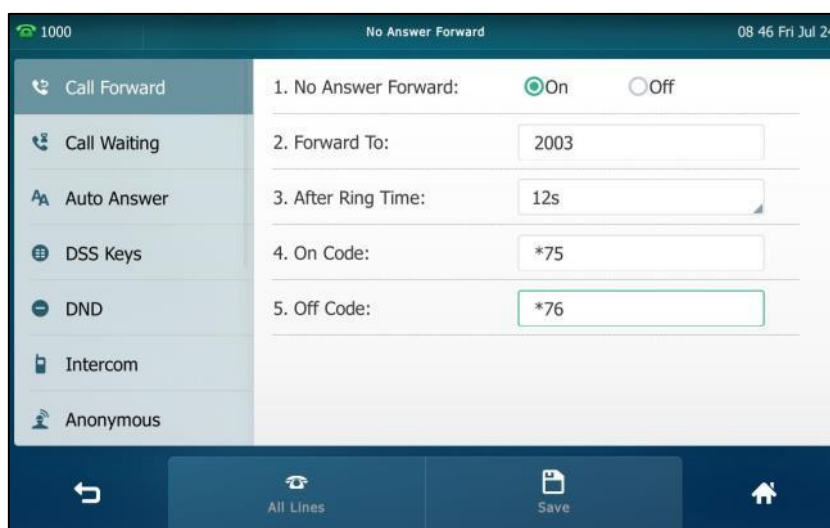

You can also enable no answer forward for all accounts. Do the following:

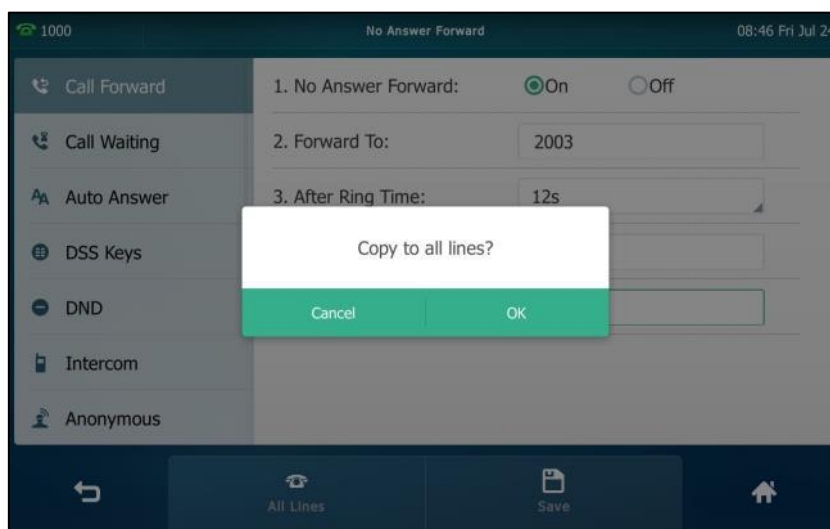

- 1) Tap the **All Lines** soft key.

The touch screen prompts “Copy to all lines?”.



- 2) Tap **OK** to accept the change or **Cancel** to cancel.

5. Tap the **Save** soft key to accept the change.

If you activate call forward for the default account, the associated line icon will change to  , and the icon  will appear on the status bar.

If you activate call forward for the non-default account, only the associated line icon will change to 📞, the icon ↶ will not appear on the status bar.



Call forward is configurable via web user interface at the path **Features->Forward & DND**.

Note

You can also enter the SIP URI or IP address in the **Forward To** field. For more information on using the SIP URI or IP address, refer to [Placing Calls](#) on page 156.

Call forward is local to the phone, and may be overridden by the server settings. Call forward on code or off code may be different among servers. For more information, contact your system administrator.

To configure the forward authorized numbers via web user interface:

1. Click on **Features->Forward & DND**.
2. Select **Enabled** from the pull-down list of **Forward Emergency**.
3. Enter the numbers in the **Forward Authorized Numbers** field.

For multiple numbers, enter a comma between every two numbers.

The screenshot shows the 'Forward' configuration page in the Yealink T49G web interface. The 'Forward Emergency' dropdown menu is set to 'Enabled', and the 'Forward Authorized Numbers' text field contains '2001,2006'. A red rectangular box highlights these two fields. Below these fields, there are sections for 'Mode' (Phone/Custom), 'Account' (1000), and three forwarding types: 'Always Forward', 'Busy Forward', and 'No Answer Forward'. Each type has 'On' and 'Off' radio buttons and 'Target', 'On Code', and 'Off Code' input fields. At the bottom, there is a 'DND' section with 'DND Emergency' set to 'Disabled' and a 'DND Authorized Numbers' field. On the right side, a 'NOTE' box explains the Forward feature and provides instructions for 'Target', 'On Code', and 'Off Code'.



4. Click **Confirm** to accept the change.

When call forward is enabled on the phone, the phone cannot forward incoming calls from the numbers specified in the **Forward Authorized Numbers** field.



Note Forward authorized number is configurable via web user interface only.

To disable call forward in phone mode:

Do one of the following:

- Tap  -> **Features**-> **Call Forward**.
Tap the desired forwarding type.
Tap the **Off** radio box.
Tap the **Save** soft key to accept the change.
- Press  when the phone is idle.
- Swipe down from the top of the screen to enter the control center, and then tap **FWD**.

To disable call forward in custom mode for a specific account:

1. Do one of the following:
 - Tap  -> **Features**-> **Call Forward**.
 - Press  when the phone is idle.
 - Swipe down from the top of the screen to enter the control center and then tap **FWD**.

The touch screen displays a list of accounts registered on the phone.

2. Tap the desired account.
3. Tap the desired forwarding type.
4. Tap the **Off** radio box.
5. Tap the **Save** soft key to accept the change.

Dynamic Forwarding

To forward an incoming call to another party:

1. When the phone is ringing, tap the **FWD** soft key.
2. Enter the number you want to forward the incoming call to.



3. Press  or tap **FWD**.
The touch screen prompts a call forward message.

Note

When the phone forwards a call, the forward call prompt window will pop up by default, if you want to disable the feature, contact your system administrator for more information.

Call Transfer



You can transfer a call to another party in one of three ways:

- **Blind Transfer:** Transfer a call directly to another party without consulting.
- **Semi-Attended Transfer:** Transfer a call when the target phone is ringing.
- **Attended Transfer:** Transfer a call with prior consulting.

Before performing a blind transfer (except you use dial number method), make sure that the transfer mode on DSS key is configured as **Blind Transfer**. Before performing a semi-attended transfer or attended transfer (except you use dial number method), make sure that the transfer mode on DSS key is configured as **New Call** or **Attended Transfer**. For more information on how to configure it, refer to [Configuring Transfer Mode on DSS Key](#) on page 226.

Blind Transfer

To perform a blind transfer:

1. Press  or tap the **Transfer** soft key during a call.
2. Do one of the following:
 - Enter the number you want to transfer the call to.
Press  to complete the transfer.
 - Enter the number you want to transfer the call to.
Tap **Transfer**.

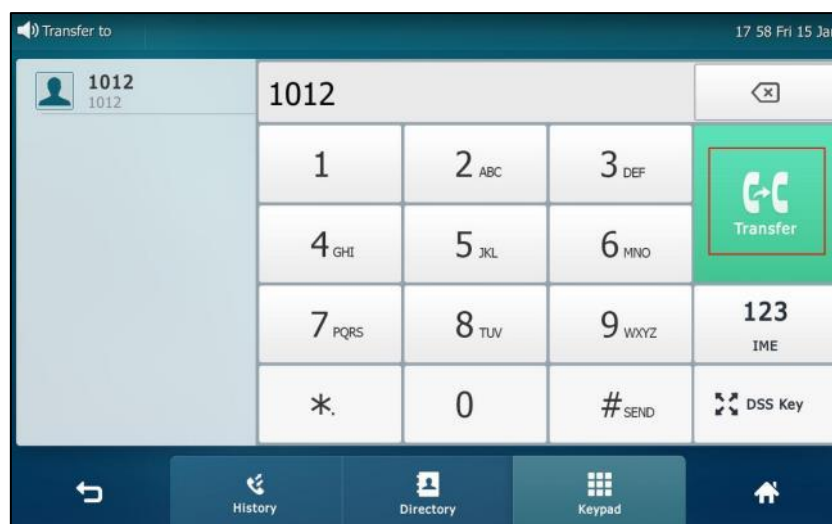

The phone will prompt a dialog box as the following picture shows:

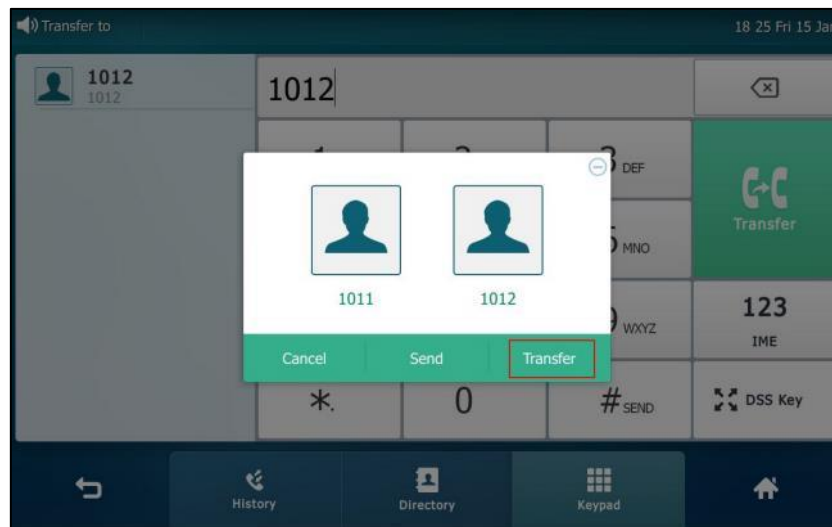



Tap **Transfer** to complete the transfer. (The call will automatically dial out in about 5 seconds if you do not tap **Transfer**.)

- Tap **Directory**, and then tap **Local Directory**. Search for the contact and tap the desired contact to complete the transfer.
- Tap **Directory**, and then tap **Remote Phone Book**. Search for the contact and tap the desired contact to complete the transfer. (Remote phone book should be configured in advance, refer to [Remote Phone Book](#) on page 104 for more information.)
- Tap **History**, and then tap the desired list. Tap the desired entry to complete the transfer.

The call is then connected to the number to which you are transferring.

Semi-Attended Transfer

To perform a semi-attended transfer:

1. Press  or tap the **Transfer** soft key during a call.
2. Do one of the following:
 - Enter the number you want to transfer the call to.
Press  to dial out.

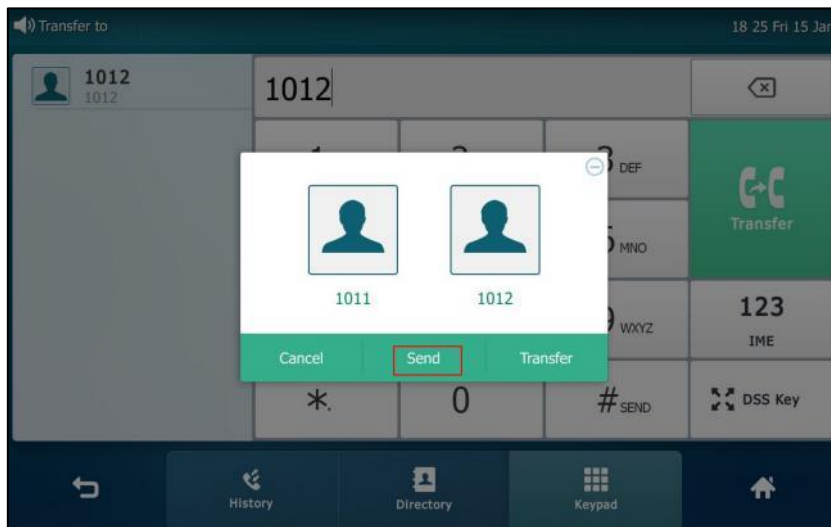

- Enter the number you want to transfer the call to.
Tap **Transfer**. The phone will prompt a dialog box. Tap **Send** to dial out. (The call will automatically dial out in about 5 seconds if you do not tap **Send**.)



- Tap **Directory**, and then tap **Local Directory**. Search for the contact and tap the desired contact to dial out.
 - Tap **Directory**, and then tap **Remote Phone Book**. Search for the contact and tap the desired contact to dial out. (Remote phone book should be configured in advance, refer to [Remote Phone Book](#) on page 104 for more information.)
 - Tap **History**, and then tap the desired list. Tap the desired entry to dial out.
3. Press  or tap the **Transfer** soft key to complete the transfer when receiving ringback.

Attended Transfer

To perform an attended transfer:

1. Press  or tap the **Transfer** soft key during a call.
2. Do one of the following:
 - Enter the number you want to transfer the call to.
Press  to dial out.
 - Enter the number you want to transfer the call to.
Tap **Transfer**. The phone will prompt a dialog box. Tap **Send** to dial out. (The call will automatically dial out in about 5 seconds if you do not tap **Send**.)
 - Tap **Directory**, and then tap **Local Directory**. Search for the contact and tap the desired contact to dial out.
 - Tap **Directory**, and then tap **Remote Phone Book**. Search for the contact and tap

the desired contact to dial out. (Remote phone book should be configured in advance, refer to [Remote Phone Book](#) on page 104 for more information.)

- Tap **History**, and then tap the desired list. Tap the desired entry to dial out.
- 3. After the party answers the call, press  or tap **Transfer** soft key to complete the transfer.

If you are using a handset, the transfer can be completed by hanging up the handset.

Call Waiting

You can enable or disable call waiting on the phone. If call waiting is enabled, you can receive another call when there is already an active call on the phone. Otherwise, another incoming call is automatically rejected by the phone with a busy message when there is an active call on the phone. You can also enable or disable the phone to play a warning tone when receiving another call.

To configure call waiting via phone user interface:

1. Tap  -> **Features**->**Call Waiting**.
2. Tap the **On** radio box in the **Call Waiting** field.
3. Tap the **On** radio box in the **Play Tone** field.
4. (Optional.) Enter the call waiting on code or off code respectively in the **On Code** or **Off Code** field.

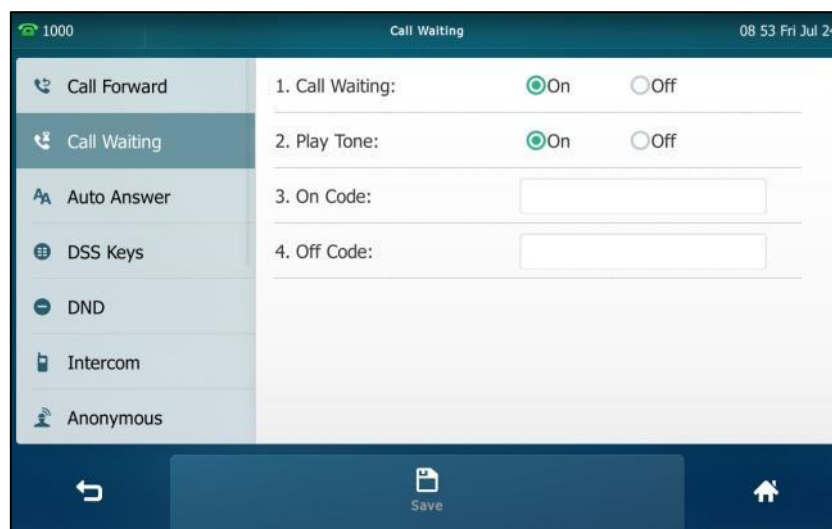

5. Tap the **Save** soft key to accept the change or  to cancel.

Call waiting is configurable via web user interface at the path **Features**->**General Information**.

Conference

You can use the SIP VP-T49G IP phone to create a conference using the phone's local conference and network conference. During a conference, you can manage each participant. You can mute, hold and remove individual participants in the video call screen. For more information on the video call screen, refer to [Video Call Screen Display](#) on page 37.

Note Network conference is not available on all servers. For more information, contact your system administrator.

Local Conference

You can create up to three-way video conference call and five-way mixture audio and video conference. The mixture audio and video conference supports five parties participated (including yourself) at the same time including a maximum of three video calls.

The following figure shows what the touch screen looks like in a mixture conference call with three video calls and two audio-only calls:

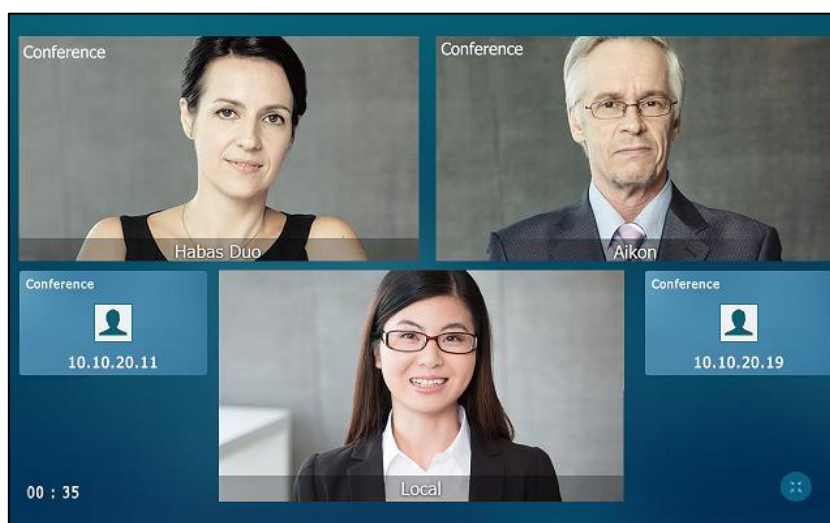

To set up a local conference call:

1. Place a call to the first party.
2. When the first party answers the call, tap the **Conference** soft key to place a new call.

The active call is placed on hold.

3. Enter the number of the second party, and then press  or tap **Conference**.

- When the second party answers the call, tap the **Conference** soft key on the second party call screen to join all parties in the conference.

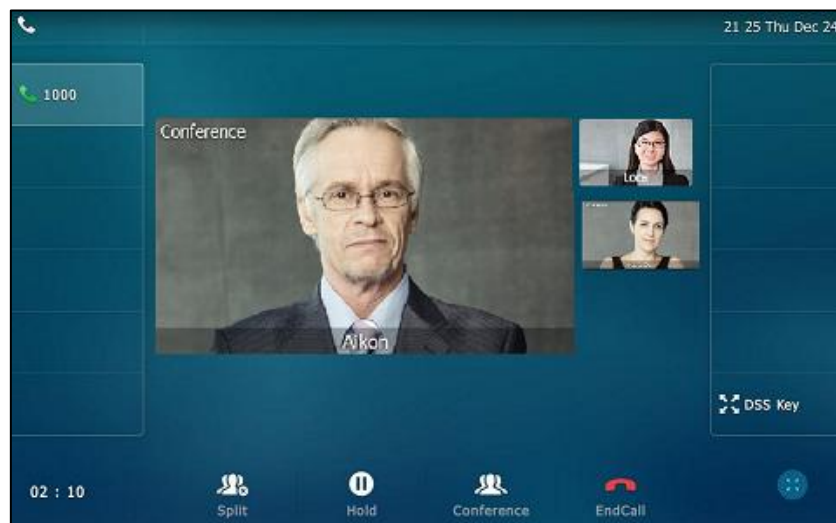

- Repeat steps 2 to 4 until you have added all intended parties.

Note

The phone will enter the video call full-screen within 5 seconds during a call, you may tap  or blank area at the top or bottom of the screen to see the soft keys.

To join calls in a conference:

- Make sure you have an active call and one or more calls on hold (either on the same line key or a different line key).
- Tap the desired call for conference and ensure that the call is active.
- Tap the **Conference** soft key.

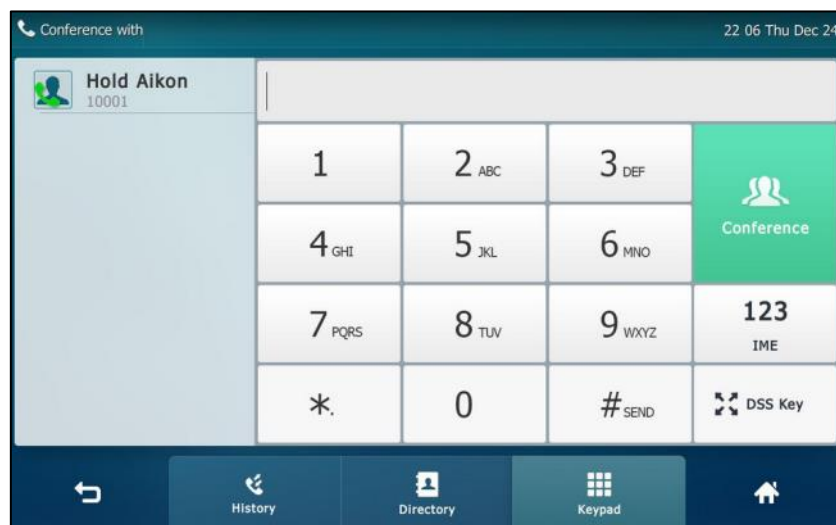

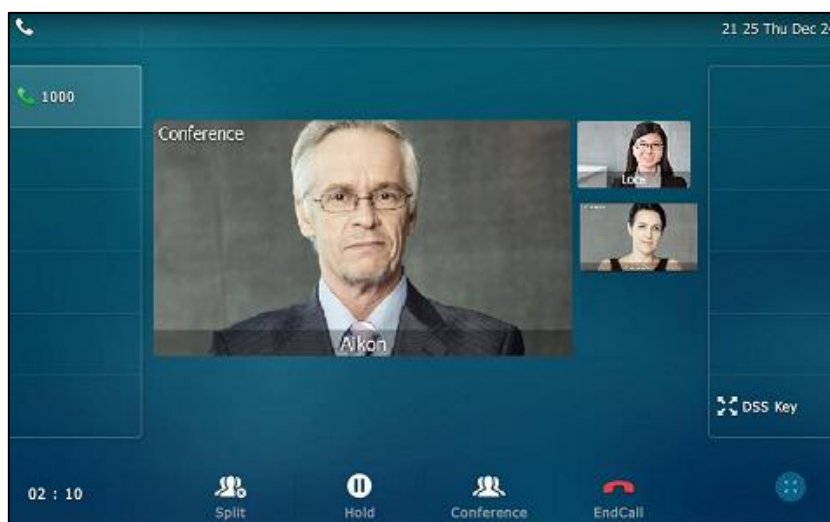

4. Tap the Hold call to join the calls in the conference.



5. Repeat steps 3, 4 to join more calls in the conference.

During the conference call, you can do the following:

- Press  or tap the **Hold** soft key to place the conference call on hold.
- Tap the **Conference** soft key to place a new call.
- Tap the **Split** soft key to split the conference call into individual calls on hold.
- Press  to mute the conference call, all other participants can hear each other, but they cannot hear you.
- Tap the **EndCall** soft key to drop the conference call.
- Long tap the desired party (if the far site only supports audio-only call, you can just tap it), the phone will prompt a dialog box as the following picture shows:

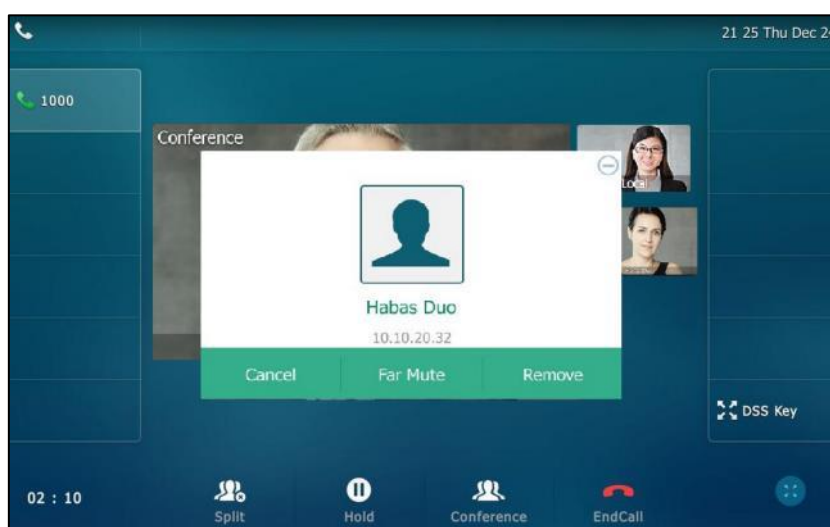

You can do the following:

- Tap **Far Mute** to mute the party. The muted party can hear everyone, but no

- one can hear the muted party.
- Tap **Remove** to remove the party.
- Tap **Cancel** or  to close the dialog box.

Network Conference

You can use network conference feature on the SIP VP-T49G IP phone to conduct an audio/video/mixture audio and video conference with multiple participants.

This feature allows you to perform the following:

- Join calls together in a conference call.
- Invite other party into an active conference call.

To use this feature, contact your system administrator for the network conference URI in advance.

Note Network conference is not available on all servers. Contact your system administrator for more information.

To configure network conference via web user interface:

1. Click on **Account->Advanced**.
2. Select the desired account from the pull-down list of **Account**.
3. Select **Network Conference** from the pull-down list of **Conference Type**.
4. Enter the conference URI (e.g., conference@example.com) in the **Conference URI** field.

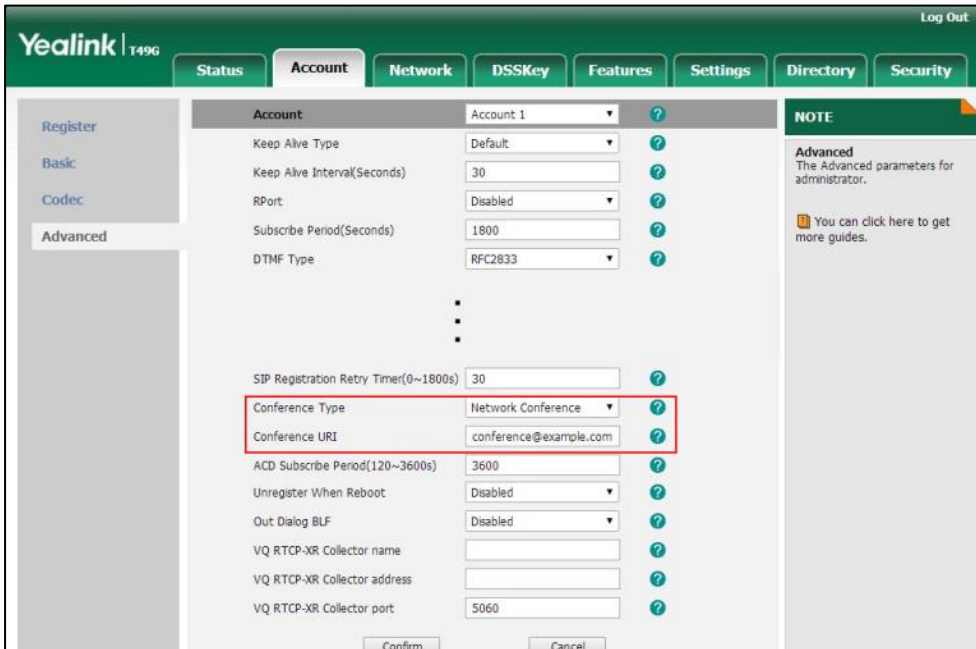

The screenshot shows the Yealink 149G web user interface. The top navigation bar includes 'Status', 'Account', 'Network', 'DSSKey', 'Features', 'Settings', 'Directory', and 'Security'. The 'Account' section is active, showing 'Account 1' selected. The 'Advanced' tab is selected, displaying various configuration options. The 'Conference Type' dropdown is set to 'Network Conference' and the 'Conference URI' field contains 'conference@example.com'. A red box highlights these two fields. A 'NOTE' box on the right indicates that advanced parameters are for administrators.



Parameter	Value
Keep Alive Type	Default
Keep Alive Interval(Seconds)	30
RPort	Disabled
Subscribe Period(Seconds)	1800
DTMF Type	RFC2833
SIP Registration Retry Timer(0~1800s)	30
Conference Type	Network Conference
Conference URI	conference@example.com
ACD Subscribe Period(120~3600s)	3600
Unregister When Reboot	Disabled
Out Dialog BLF	Disabled
VQ RTPC-XR Collector name	
VQ RTPC-XR Collector address	
VQ RTPC-XR Collector port	5060

5. Click **Confirm** to accept the change.

Note

Network conference is configurable via web user interface only.

To set up a network conference call:

1. Place a call to the first party.
2. Tap the **Conference** soft key to place a new call.
The active call is placed on hold.
3. Enter the number of the second party and press  or tap **Conference**.
4. When the second party answers the call, tap the **Conference** soft key to add the second party to the conference.
5. Tap the **Conference** soft key to place a new call.
The conference call is placed on hold.
6. Enter the number of the new party and then press  or tap **Conference**.
7. When the new party answers the call, tap the **Conference** soft key to add the new party to the conference.
8. Repeat steps 5 to 7 until you have added all intended parties.

The procedures to set up a network conference call on specific servers may be different from introduced above. Contact your system administrator for more information.

Call Park

You can use call park to place a call on hold, and then retrieve the call from another phone in the system (for example, a phone in another office or conference room). You can park an active call by tapping the call park key on the phone. If the call is parked successfully, the response is either a voice prompt confirming that the call was parked, or a visible prompt on the touch screen.

Note

Call park is not available on all servers. Contact your system administrator for more information.

To configure a call park key via phone user interface:

1. Tap  -> **Features**->**DSS Keys**.
2. Tap the desired line key.
3. Tap the **Type** field.
4. Tap **Key Event** in the pop-up dialog box.
5. Tap the **Key Type** field.
6. Tap **Call Park** in the pop-up dialog box.

7. Tap the **Account ID** field.
8. Tap the desired line in the pop-up dialog box.
9. (Optional.) Enter the string that will appear on the touch screen in the **Label** field.
10. Enter the call park code in the **Value** field.

The screenshot shows a mobile application interface for configuring a DSSKey. The screen has a dark blue header with the text 'DssKey 20' and a status bar at the top showing '1000' on the left and '15:38 Thu Aug 06' on the right. The main content area is white and contains five rows of configuration options, each with a label and a text input field:

- 1. Type: Key Event
- 2. Key Type: Call Park
- 3. Account ID: Line 1
- 4. Label: (empty field)
- 5. Value: *04

At the bottom of the screen is a dark blue navigation bar with three icons: a back arrow on the left, a 'Save' button in the center, and a home icon on the right.

11. Tap the **Save** soft key to accept the change or  to cancel.

Call park key is configurable via web user interface at the path **DSSKey->Line Key**.

To use call park:

1. User on phone A places a call to phone B.
2. User on phone A wants to take the call in a conference room for privacy, and so taps the call park key on phone A.
3. User on phone A walks to an available conference room where the phone is designated as phone C. The user dials the call park retrieve code to retrieve the parked call.

The system establishes the call between phone C and B.

Note

The call park code and call park retrieve code are predefined on the system server. Contact your system administrator for more information.

If the parked call is not retrieved within a period of time assigned by the system, the phone performing call park will receive a call back.

Call Pickup

You can use call pickup to answer someone else's incoming call on your phone. The SIP VPT49G IP phone supports directed call pickup and group call pickup. Directed call pickup is used for picking up a call that is ringing at a target phone number. Group call pickup is used for picking up a call that is ringing at any phone number in a certain

group. The pickup group should be predefined, contact your system administrator for more information.

You can pick up an incoming call by using **DPickup/GPickup**. To use call pickup, you need to configure the call pickup code beforehand on a global or per-line basis via web user interface. The call pickup code configured on a per-line basis takes precedence over that configured on a global basis.

Note If there are many incoming calls at the same time, tapping the **GPickup** on the phone will pick up the call that rings first.

Directed Call Pickup

To enable directed call pickup and configure the directed call pickup code on a global basis via web user interface:

1. Click on **Features->Call Pickup**.
2. Select **Enabled** from the pull-down list of **Directed Call Pickup**.
3. Enter the directed call pickup code in the **Directed Call Pickup Code** field.

The screenshot shows the 'Call Pickup' configuration page in the Yealink T49G web interface. The 'Features' tab is selected. The 'Directed Call Pickup' dropdown menu is set to 'Enabled', and the 'Directed Call Pickup Code' text field contains '*97'. A red rectangular box highlights these two fields. Below these fields are other options: 'Group Call Pickup' (Disabled), 'Group Call Pickup Code' (empty), 'Visual Alert for BLF Pickup' (Disabled), and 'Audio Alert for BLF Pickup' (Disabled). Each option has a help icon. At the bottom are 'Confirm' and 'Cancel' buttons. On the right, a 'NOTE' box provides additional information and a link to guides.

4. Click **Confirm** to accept the change.

To configure the directed call pickup code on a per-line basis via web user interface:

1. Click on **Account->Advanced**.
2. Select the desired account from the pull-down list of **Account**.

- Enter the directed call pickup code in the **Directed Call Pickup Code** field.

The screenshot shows the Yealink T49G web interface. The 'Account' tab is selected, and the 'Advanced' section is expanded. The 'Directed Call Pickup Code' field is highlighted with a red box and contains the value '*97'. Other fields include 'Keep Alive Type' (Default), 'Keep Alive Interval(Seconds)' (30), 'RPort' (Disabled), 'Music Server URI', 'Group Call Pickup Code', 'Distinctive Ring Tones' (Enabled), 'MWI Subscription Period(Seconds)' (3600), 'Subscribe MWI To Voice Mail' (Disabled), 'VQ RTPC-XR Collector address', and 'VQ RTPC-XR Collector port' (5060). A 'NOTE' section on the right indicates that advanced parameters are for administrators and provides a link to more guides. 'Confirm' and 'Cancel' buttons are at the bottom.

- Click **Confirm** to accept the change.

To pick up a call directly:

- Pick up the handset, press the Speakerphone key or tap the line key. **DPickup** appears on the onscreen keyboard.

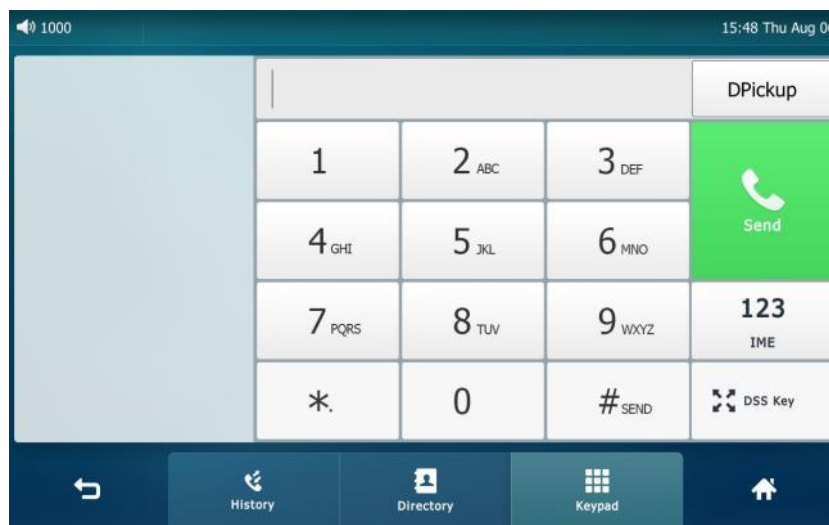

- Tap **DPickup** on your phone when the target phone receives an incoming call.
- Enter the phone number which is receiving an incoming call.
- Tap **DPickup** again.

The call is answered on your phone.

You can also configure a line key as a direct pickup key via phone user interface or web user interface. Once configured, you can pick up a call by tapping the direct pickup key directly. For more information, refer to [Line Keys](#) on page 130.

Group Call Pickup

To enable group call pickup and configure the group call pickup code on a global basis via web user interface:

1. Click on **Features->Call Pickup**.
2. Select **Enabled** from the pull-down list of **Group Call Pickup**.
3. Enter the group call pickup code in the **Group Call Pickup Code** field.



The screenshot shows the 'Call Pickup' configuration page in the Yealink T49G web interface. The 'Features' tab is selected. The 'Group Call Pickup' field is highlighted with a red box, showing it is set to 'Enabled' and the code is '*98'. Other fields include 'Directed Call Pickup' (Enabled, *97), 'Visual Alert for BLF Pickup' (Disabled), and 'Audio Alert for BLF Pickup' (Disabled). A 'NOTE' section on the right states: 'Call Pickup: The call pickup parameters for administrator. You can click here to get more guides.'

4. Click **Confirm** to accept the change.

To configure the group call pickup code on a per-line basis via web user interface:

1. Click on **Account->Advanced**.
2. Select the desired account from the pull-down list of **Account**.
3. Enter the group call pickup code in the **Group Call Pickup Code** field.

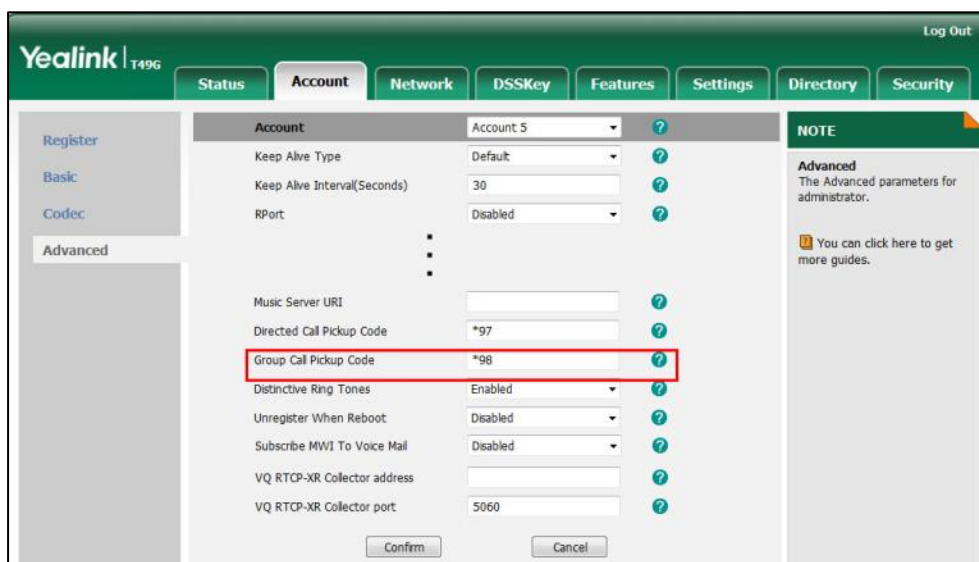

The screenshot shows the 'Account' configuration page in the Yealink T49G web interface. The 'Account' tab is selected, and the 'Advanced' sub-tab is active. The 'Group Call Pickup Code' field is highlighted with a red box, showing it is set to '*98'. Other fields include 'Keep Alive Type' (Default), 'Keep Alive Interval(Seconds)' (30), 'RPort' (Disabled), 'Music Server URI', 'Directed Call Pickup Code' (*97), 'Distinctive Ring Tones' (Enabled), 'Unregister When Reboot' (Disabled), 'Subscribe MWI To Voice Mail' (Disabled), 'VQ RTPC-XR Collector address', and 'VQ RTPC-XR Collector port' (5060). A 'NOTE' section on the right states: 'Advanced: The Advanced parameters for administrator. You can click here to get more guides.'

4. Click **Confirm** to accept the change.

To pick up a call in the group:

1. Pick up the handset, press the Speakerphone key or tap the line key.
GPickup appears on the onscreen keyboard.



2. Tap **GPickup** on your phone when a phone in the group receives an incoming call.
The call is answered on your phone.

You can also configure a line key as a group pickup key via phone user interface or web user interface. Once configured, you can pick up a call by tapping the group pickup key directly.

Note

The directed call pickup code and group call pickup code are predefined on the system server. Contact your system administrator for more information.

Anonymous Call

You can use anonymous call to block your identity and phone number from appearing to the called party when you call someone. For example, you want to call to consult some of the services, but don't want to be harassed. Anonymous call is configurable on a per-line basis. You can also configure the phone to send anonymous call on/off code to the server to activate/deactivate anonymous call on the server side.

Note

Anonymous call is not available on all servers. Contact your system administrator for the anonymous call on code and off code.

To configure anonymous call via phone user interface:

1. Tap  -> **Features**->**Anonymous**.
2. Tap the desired line.
3. Tap the **On** radio box in the **Local Anonymous** field.

4. (Optional.) Tap the **On Code** or **Off Code** radio box in the **Send Anony Code** field.
5. (Optional.) Enter the anonymous call on code and off code respectively in the **On Code** and **Off Code** field beneath the **Send Anony Code** field.

The phone will send the configured on code or off code depending on your selection when you enable or disable anonymous call feature on the phone.



6. Tap the **Save** soft key to accept the change or to cancel.

Anonymous call is configurable via web user interface at the path **Account->Basic**.

To place an anonymous call:

1. Using the specific line on the phone to place a call to phone B.
The touch screen of phone B prompts an incoming call from anonymous.

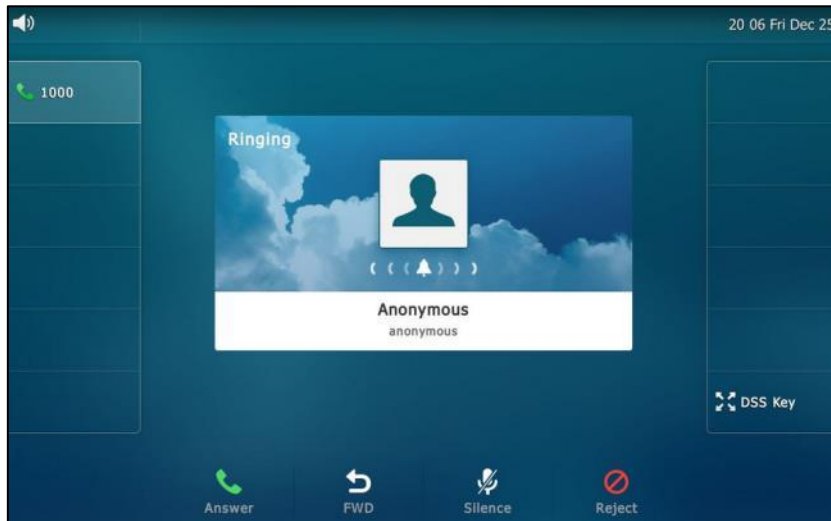

Anonymous Call Rejection

You can use anonymous call rejection to reject incoming calls from anonymous callers.

Anonymous call rejection automatically rejects incoming calls from callers who deliberately block their identities and numbers from being displayed. Anonymous call rejection is configurable on a per-line basis. You can also configure the phone to send anonymous call rejection on/off code to the server to activate/deactivate anonymous call rejection on the server side.

To configure anonymous call rejection via phone user interface:

1. Tap  -> **Features**->**Anonymous**.
2. Tap the desired line.
3. Tap the **On** radio box in the **Anonymous Rejection** field.
4. (Optional.) Tap the **On Code** or **Off Code** radio box in the **Send Rejection Code** field.
5. (Optional.) Enter the anonymous call rejection on code and off code respectively in the **On Code** and **Off Code** field beneath the **Send Rejection Code** field.

The phone will send the configured on code or off code depending on your selection when you enable or disable anonymous call rejection feature on the phone.



6. Tap the **Save** soft key to accept the change or  to cancel.

Anonymous call rejection is configurable via web user interface at the path **Account->Basic**.

If phone B has anonymous call feature enabled and places a call to your phone, the call will be rejected, and the touch screen of the phone B will display the following:

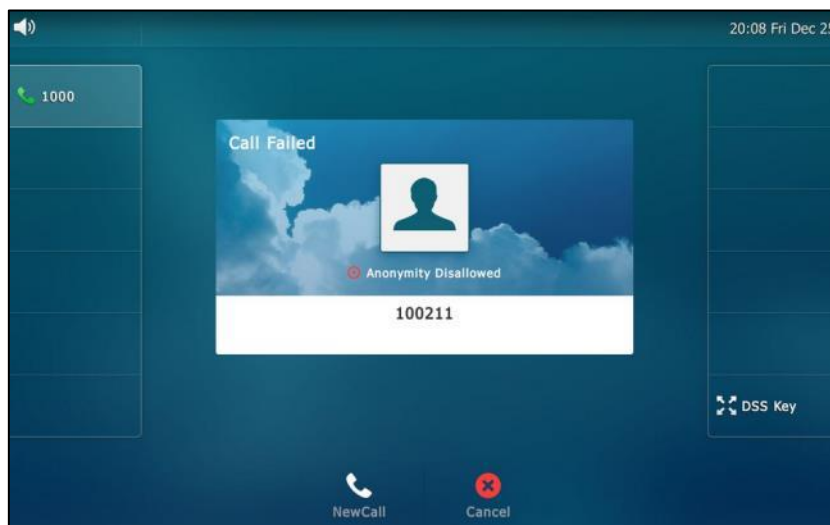

Capturing Screenshots during a Video Call

You can capture the screenshots during a video call via phone user interface. Before capturing the screenshot, ensure that the USB flash drive has been connected to your phone. The USB flash drive can store the screenshots.

The screenshots are saved in *.jpg format and include a date & time stamp and the other party's number/IP address/name (or the first person's number/IP address/name you called), for example, 20150731-1630-Mishoel.jpg was created on July 31, 2015, at 16:30 and you have a call with Mishoel.

Note If the call is audio-only, you cannot capture the screenshot.

To capture screenshots during a video call via phone user interface, do one of the following:

- Tap the **More** soft key.

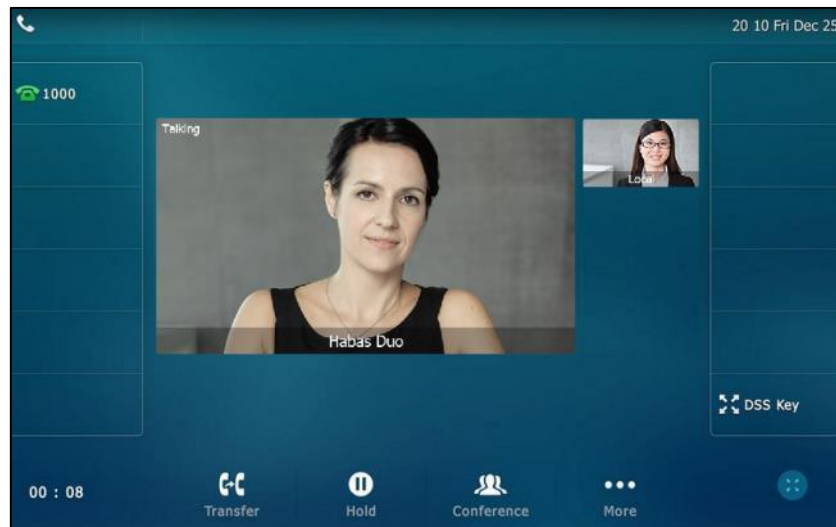

Tap the **Screenshot** soft key if you want to capture the picture.

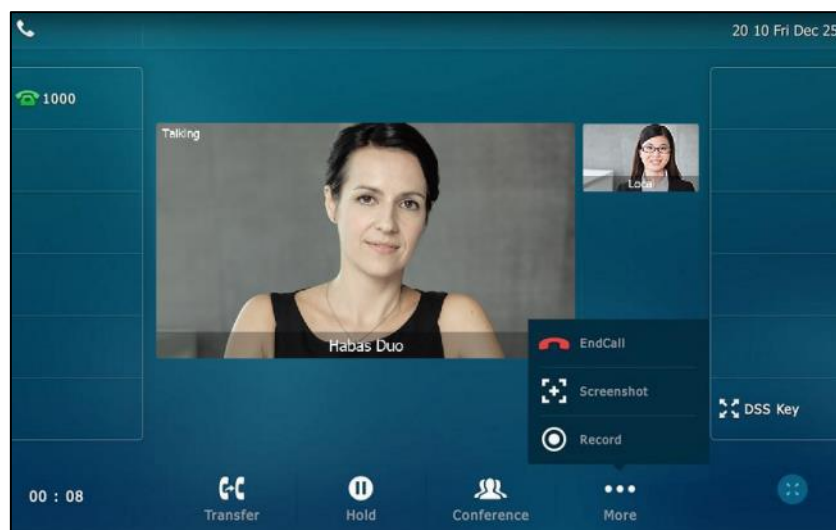

- Press .

The status bar prompts “Screenshot has been saved to the USB device successfully.”.

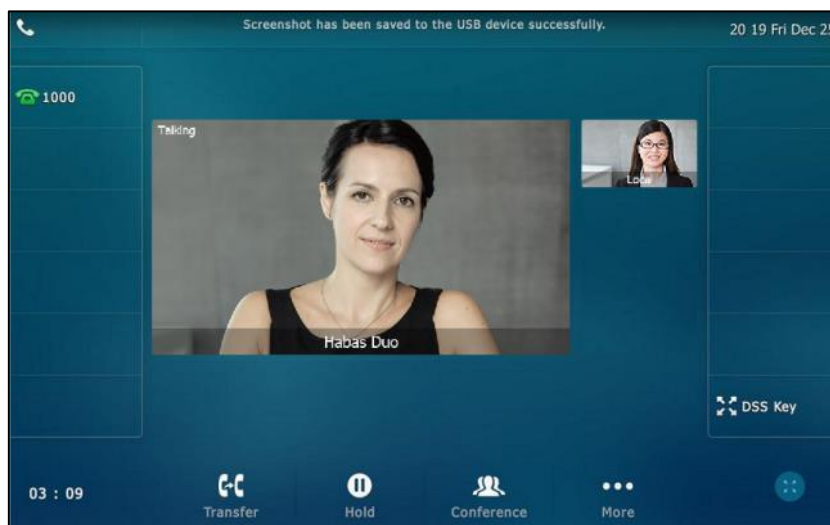



You can view the screenshots that stored in the USB flash drive. For more information, refer to [Viewing the Pictures Stored in Your USB Flash Drive](#) on page 221.

Note

If you want to remove the USB flash drive, please wait until the status bar prompts “Screenshot has been saved to the USB device successfully.”.

When you connect a USB flash drive to your phone, you have to tap **More->EndCall** to end a call.

To delete screenshots via phone user interface:

1. Tap  -> **USB->Browse Photo.**
2. Do one of the following:
 - Tap  after the screenshot you want to delete.
 - Tap the desired screenshot to preview, and then tap **Delete.**

The phone prompts “Delete this photo?”

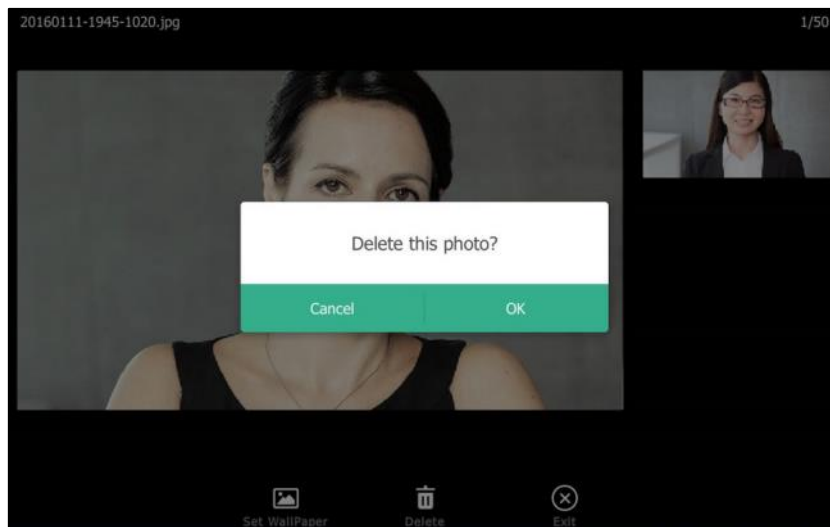

3. Tap **OK** to accept the change or **Cancel** to cancel.

Viewing the Pictures Stored in Your USB Flash Drive

You can view the pictures that are stored in your USB flash drive at any time. You can display your pictures as lists, or display just one picture. Before displaying the pictures, ensure that the USB flash drive has been connected to your phone. For more information, refer to [Phone Installation](#) on page 29.

To view pictures stored in the USB flash drive via phone user interface:

1. Tap  -> **USB->Browse Photo**.
Your pictures will display as lists.

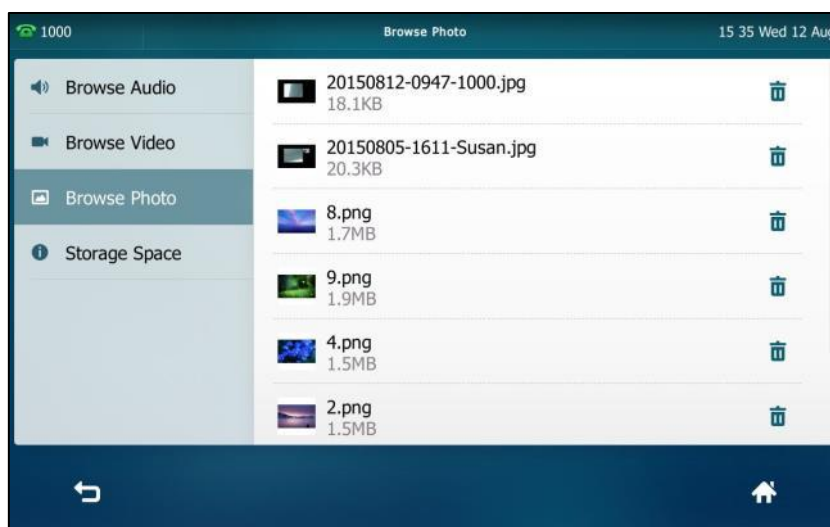

2. Tap the desired photo to view.

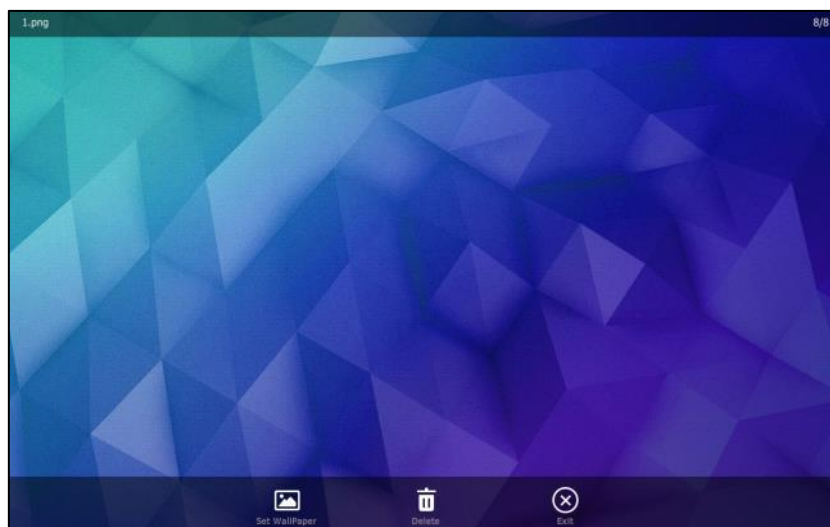

You can do one of the following:

- Tap **Set Wallpaper** to set the picture as the wallpaper for your phone. For more information, refer to [Setting Wallpaper](#) on page 63.
- Tap **Delete** to delete the picture.
The touch screen prompts "Delete this photo?".

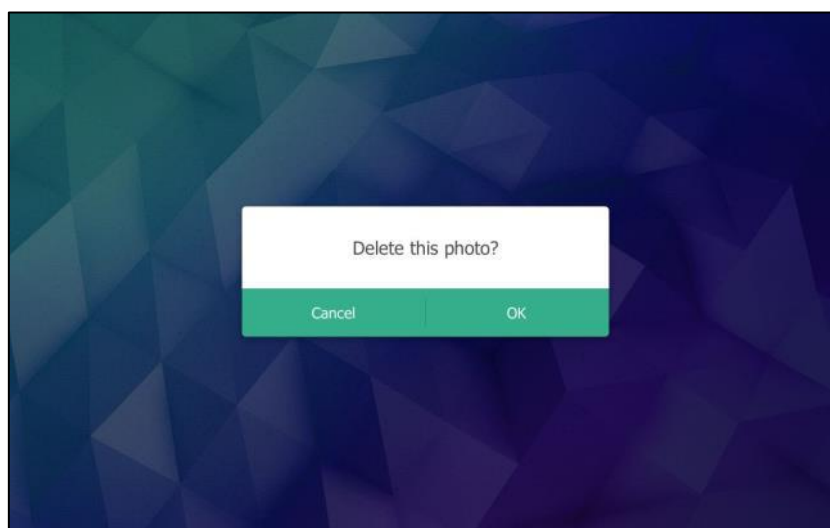

Tap **OK** to accept the change.

- Tap **Exit** to stop displaying the picture.
- Swipe left or right to view the next picture or previous picture.

Note The soft keys (**Set Wallpaper**, **Delete** and **Exit**) are hidden after they display 5 seconds, unless you tap the touch screen.

Advanced Phone Features

This chapter provides operating instructions for the advanced features of the SIP VP-T49G IP phone. Topics include:

- [Busy Lamp Field \(BLF\)](#)
- [BLF List](#)
- [Call and Conference Recording Using a USB Flash Drive](#)
- [Call Recording Using a Record Key](#)
- [Hot Desking](#)
- [Intercom](#)
- [Multicast Paging](#)
- [Music on Hold](#)
- [Automatic Call Distribution \(ACD\)](#)
- [Shared Call Appearance \(SCA\)](#)
- [Messages](#)

If you require additional information or assistance with your new phone, contact your system administrator.

Busy Lamp Field (BLF)

You can use BLF to monitor a specific line for status changes on the phone. For example, you can configure a BLF key on the phone to monitor the status of a friend's line (busy or idle). The BLF key icon illuminates solid red when the friend's line is in use. For more information, contact your system administrator.

Configuring the BLF Feature on the Phone

You need to configure the IP phone to perform BLF monitoring. IP phones being monitored do not require any configuration.

Configuring a BLF Key

To configure a BLF key via phone user interface:

1. Tap ->Features->DSS Keys.
2. Tap the desired line key.
3. Tap the **Type** field.

4. Tap **BLF** in the pop-up dialog box.
5. Tap the **Account ID** field.
6. Tap the desired line in the pop-up dialog box.
7. (Optional.) Enter the string that will appear on the touch screen in the **Label** field.
8. Enter the phone number or extension you want to monitor in the **Value** field.
9. (Optional.) Enter the directed call pickup code in the **Extension** field.

If it is configured, when the monitored user receives an incoming call, the supervisor can tap the BLF key to pick up the call directly.

The screenshot shows a configuration screen for a DSSKey. The fields are as follows:

1. Type:	BLF
2. Account ID:	Line 1
3. Label:	10111
4. Value:	10111
5. Extension:	*33

At the bottom of the screen, there are three soft keys: a back arrow, a 'Save' button with a floppy disk icon, and a home button with a house icon.

10. Tap the **Save** soft key to accept the change or  to cancel.

BLF key is configurable via web user interface at the path **DSSKey->Line key**.

Configuring Visual and Audio Alert for BLF pickup

You can enable audio alert feature for BLF pickup on the phone. This allows the monitoring phone to play a warning tone when the monitored line receives an incoming call. You can also enable visual alert feature for BLF pickup on the phone. This allows the touch screen of the monitoring phone to display the caller ID when the monitored line receives an incoming call.

To enable visual and audio alert features via web user interface:

1. Click on **Features->Call Pickup**.
2. Select **Enabled** from the pull-down list of **Visual Alert for BLF Pickup**.

3. Select **Enabled** from the pull-down list of **Audio Alert for BLF Pickup**.



4. Click **Confirm** to accept the change.

Note

Visual and audio alert features are configurable via web user interface only.

When the monitored line receives an incoming call, the following occurs on your phone:

- The phone plays a warning tone (if enabled).
- The BLF key icon flashes red.
- The caller ID appears on the touch screen (if enabled).

In the following figure, the touch screen shows an incoming call from 1058 on the monitored line.

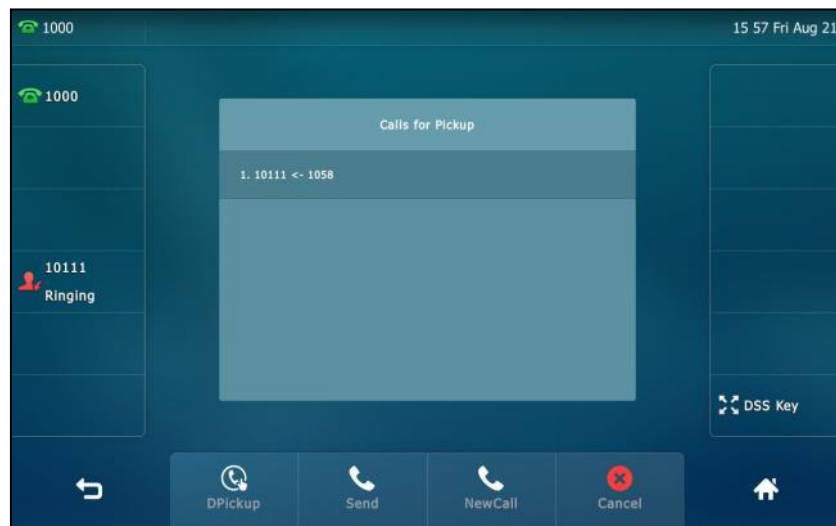

You can do the following actions:

- Tap the **DPickup** soft key to pick up the call.
- Tap the **Send** soft key to dial out the monitored phone number.
- Tap the **NewCall** soft key to place a new call.
- Tap the **Cancel** soft key to exit the screen.

Note If your phone is locked, you cannot use the **DPickup**, **Send**, **NewCall** and **Cancel** soft keys until unlocked. For more information refer to [Phone Lock](#) on page 75.

Configuring Transfer Mode on DSS Key

When there is an active call on the IP phone, you can handle the active call differently depending on the transfer mode on DSS key.

To configure the transfer mode on DSS key via web user interface:

1. Click on **Features->Transfer**.
2. Select the desired transfer mode from the pull-down list of **Transfer Mode via Dsskey**.
 - If you select **Blind Transfer**, tap the BLF key to blind transfer the call to the monitored user.
 - If you select **Attended Transfer**, tap the BLF key to dial out the monitored phone number and then perform an attended or a semi-attended transfer.
 - If you select **New Call**, tap the BLF key to place a new call to the monitored user. The original call is placed on hold.

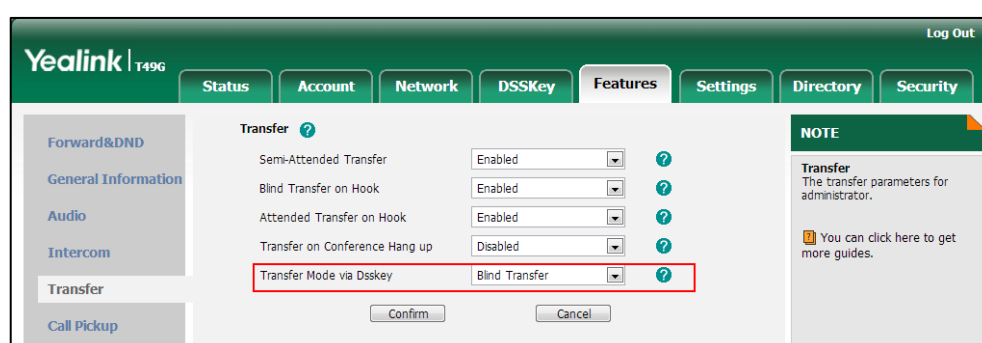

3. Click **Confirm** to accept the change.

Configuring Directed Call Pickup Code

If you configure the directed call pickup code in advanced, you can pick up the monitored user's incoming call by tapping the BLF key. You can configure the directed

call pickup code when configuring a BLF key. For more information, refer to [Configuring a BLF Key](#) on page 223. You can also configure the directed call pickup code on a global or per-line basis via web user interface.

If you enable visual alert feature, you can also pick up the monitored user's incoming call by tapping **DPickup** soft key. To use **DPickup** soft key to pick up the call, the call pickup code can only be configured on a global or per-line basis via web user interface.

Note

The pickup code is used in the following order of preference: Extension (DSSKey->Line Key)>Directed Call Pickup Code (Account->Advanced)>Directed Call Pickup Code (Features->Call Pickup). If pickup code is not configured, tapping the BLF key/**DPickup** soft key will directly call the monitored user when he/she receives an incoming call.

To configure directed call pickup feature on a global basis via web user interface:

1. Click on **Features->Call Pickup**.
2. Enter the desired pickup code in the **Directed Call Pickup Code** field.

The screenshot shows the 'Call Pickup' configuration page in the Yealink T49G web interface. The 'Features' tab is selected. The 'Directed Call Pickup' dropdown is set to 'Disabled'. The 'Directed Call Pickup Code' text input field is highlighted with a red box and contains the value '*8'. Below it, the 'Group Call Pickup' dropdown is also set to 'Disabled'. The 'Visual Alert for BLF Pickup' and 'Audio Alert for BLF Pickup' dropdowns are both set to 'Enabled'. At the bottom of the form are 'Confirm' and 'Cancel' buttons. On the right side, there is a 'NOTE' box with the text: 'Call Pickup The call pickup parameters for administrator. You can click here to get more guides.'

3. Click **Confirm** to accept the change.

To configure the directed call pickup code on a per-line basis via web user interface:

1. Click on **Account->Advanced**.
2. Select the desired account from the pull-down list of **Account**.

- Enter the desired pickup code in the **Directed Call Pickup Code** field.

The screenshot shows the Yealink T49G web interface with the 'Account' tab selected. The 'Account' section is expanded, showing various configuration fields. The 'Directed Call Pickup Code' field is highlighted with a red box and contains the value '*8'. Other fields include 'Keep Alive Type', 'Keep Alive Interval(Seconds)', 'RPort', 'Subscribe Period(Seconds)', 'DTMF Type', 'Music Server URI', 'Group Call Pickup Code', 'Distinctive Ring Tones', 'Unregister When Reboot', 'Out Dialog BLF', 'VQ RTPC-XR Collector name', 'VQ RTPC-XR Collector address', and 'VQ RTPC-XR Collector port'. A 'NOTE' section on the right indicates that these are advanced parameters for administrators.

- Click **Confirm** to accept the change.

Using BLF Feature on the Phone

You can use the BLF key in the following ways:

- Place a call to the monitored user.
- Transfer a call to the monitored user.
- Pick up an incoming call of the monitored user.

Placing a Call to the Monitor User

You can tap a BLF key to dial out the monitored phone number when the monitored line is idle.

To place a call to the monitored user when the IP phone is idle:

- Tap the BLF key.
The IP phone dials out the phone number of the monitored user.

Transferring a Call to the Monitored User

When there is already an active call on the IP phone, you can transfer the active call to the monitored user by tapping the BLF key. The phone handles the active call differently depending on the transfer mode on DSS key (refer to [Configuring Transfer Mode on DSS Key](#)). The transfer mode on DSS key has the following modes:

- Blind Transfer

- Attended Transfer
- New Call

To perform a blind transfer:

When the transfer mode on DSS key is set to **Blind Transfer** and there is already an active call on the IP phone, you can do the following:

1. Tap the BLF key of the monitored user which you want to transfer this call to.
Then the active call is connected to the number of the monitored user.

To perform a semi-attended transfer:

When the transfer mode on DSS key is set to **Attended Transfer** and there is already an active call on the IP phone, you can do the following:

1. Tap the BLF key of the monitored user which you want to transfer this call to. The phone will dial the number of the monitored user.
2. Tap the BLF key of the monitored user again or the **Transfer** soft key to complete the transfer when receiving ringback.

To perform an attended transfer:

When the transfer mode on DSS key is set to **Attended Transfer** and there is already an active call on the IP phone, you can do the following:

1. Tap the BLF key of the monitored user which you want to transfer this call to. The phone will dial the number of the monitored user.
2. Tap the BLF key of the monitored user again or the **Transfer** soft key to complete the transfer after the monitored user answers the call.

To perform a new call:

When the transfer mode on DSS key is set to **New Call** and there is already an active call on the IP phone, you can do the following:

1. Tap the BLF key of the monitored user you want to call.
The phone will dial the number of the monitored user.

Picking up an Incoming Call of the Monitored User

When the monitored user receives an incoming call, the BLF key icon indicator of the monitored user will become  and flashing. If you enable visual and audio alert features on the phone, the phone will play a warning tone and display the incoming call information on the touch screen. You can use the BLF key to pick up an incoming call of the monitored user. Before picking up an incoming call, ensure that the directed call pickup code has been configured in advance.

To pick up an incoming call when the IP phone is idle:

1. Tap the BLF key.

The incoming call of the monitored user is answered on the IP phone.

Note

If the call pickup code is not configured, the phone will place a call to the monitored user instead of picking up an incoming call of the monitored user when you tap the BLF key.

BLF List

You can use the BLF List feature to monitor a list of users defined by your system administrator. For example, your system administrator enables BLF List, and creates a BLF List URI (e.g., BLFList@example.com) including a list of user1, user2 on the server. The BLF List keys on the IP phone can present the status of user1 and user2. The key icons illuminate flashing or solid depending on the status of those users. For more BLF List key icon indicator, refer to [Icon indicator \(associated with BLF/BLF List\)](#) on page 19.

You can use the BLF List keys in the following ways:

- When the monitored user is idle, tap the BLF list key to dial out the phone number.
- When there is already an active call on the IP phone, you can transfer the active call to the monitored user by tapping the BLF List key. The phone handles the active call differently depending on the transfer mode on DSS key. For more information on the transfer mode on DSS key, refer to [Configuring Transfer Mode on DSS Key](#) on page 226.
- When the monitored user receives an incoming call, tap the BLF list key to pick up the call directly. Before picking up an incoming call, ensure that the BLF List Pickup Code has been configured in advance. If the code is not configured, the phone will place a call to the monitored user instead of picking up the incoming call of the monitored user when you tap the BLF List key.
- When there is a conversation on the monitored user, tap the BLF list key to barge in and set up a conference call. Before barging in an active call, ensure that the BLF List Barge In Code has been configured in advance. If the code is not configured, the phone will place a call to the monitored user instead of barging in an active call of the monitored user when you tap the BLF List key.
- When a call is being parked against the monitored phone, tap the BLF List key to retrieve the parked call from the monitored user. Before retrieving the parked call, ensure that the BLF List Retrieve Call Parked Code has been configured in advance. If the code is not configured, the phone will place a call to the monitored user instead of retrieving the parked call when you tap the BLF List key.

To configure BLF List settings via web user interface:

1. Click on **Account->Advanced**.
2. Select the desired account from the pull-down list of **Account**.
3. Enter the BLF List URI in the **BLF List URI** field.
4. (Optional.) Enter the directed pickup code in the **BLF List Pickup Code** field.
5. (Optional.) Enter the barge-in code in the **BLF List Barge In Code** field.
6. (Optional.) Enter the call park retrieve code in the **BLF List Retrieve Call Parked Code** field.

The screenshot shows the Yealink T49G web interface. The 'Account' tab is selected, and the 'Advanced' sub-tab is active. A table of settings is displayed, with a red box highlighting the BLF List settings. The settings are as follows:

Field	Value
BLF List URI	4609@yealink.com
BLF List Pickup Code	*97
BLF List Barge In Code	*33
BLF List Retrieve Call Parked Code	*88

Other visible settings include: Keep Alive Type (Default), Keep Alive Interval (30), RPort (Disabled), Subscribe Period (1800), DTMF Type (RFC2833), PTime (20), and Out Dialog BLF (Disabled). The interface also includes a 'NOTE' section on the right and 'Confirm' and 'Cancel' buttons at the bottom.

7. Click **Confirm** to accept the change.

Note

For more information on BLF List URI/BLF List Pickup Code/BLF List Barge In Code/BLF List Retrieve Call Parked Code, contact your system administrator.

According to the response message from the server, the IP phone will automatically configure the BLF List keys beginning from the first unused DSS key. Once any DSS key is seized, the IP phone will skip to configure the next DSS key.

You can receive a visual or/and an audio alert (if enabled) on your phone when the monitored user receives an incoming call. For more information, refer to [Configuring Visual and Audio Alert for BLF pickup](#) on page 224.

Note

The pickup code is used in the following order of preference: BLF List Pickup Code (Account->Advanced)>Directed Call Pickup Code (Account->Advanced)>Directed Call Pickup Code (Features->Call Pickup). If all of them are not configured, tapping the BLF List key will directly call the monitored user when he/she receives an incoming call. For more information about pickup code, refer to [Call Pickup](#) on page 211.

Call and Conference Recording Using a USB Flash Drive

When you insert a USB flash drive into the USB port on your phone, you can record active calls or conferences (audio-only or video calls) by tapping the **Record** soft key on your phone.

The recorded video calls are saved in *.mkv format and include a date & time stamp and the other party's number/IP address/name (or the first person's number/IP address/name you called), for example, 20150731-1630-Mishoel.mkv was created on July 31, 2015, at 16:30 and you have a call with Mishoel. The recorded audio-only calls are saved in *.aac format. The recorded calls are stored at the path  ->USB, you can play it back on your phone.

The approximate time remaining for recording (the free space for the USB device) is shown at the path **Menu->USB->Storage Space**.

Note

If you use a record key to record a call, the recorded file will be stored in servers. For more information, refer to [Call Recording Using a Record Key](#) on page 239.

Before recording any call, especially those involving PSTN, it is necessary to know about the rules and restrictions of any governing call-recording in the place you are in. It is also very important to have the consent of the person you are calling before recording the conversation.

The Record soft key controls the recording function, and is available (you need to tap the More soft key to see it):

- When there are one or more calls connected to your phone
- During an active call
- When calls are on hold or muted
- During a semi-attended or attended transfer
- During a conference call

The Record soft key is not available:

- When there are no connected calls on your phone
- When you place a new call (to transfer or to conference)
- When the phone prompts you to answer an incoming call

The recording is not be paused when the following occurs:

- You place a call on hold.
- You mute a call.
- You set up a conference call
- You perform the semi-attended or attended transfer

- An incoming calls arrives on your phone

Call Recording

To record a call via phone user interface:

1. Tap the **More** soft key and then tap the **Record** soft key during a call.



If the recording starts successfully, the recording icon  and recording time will appear on the status bar of the touch screen.

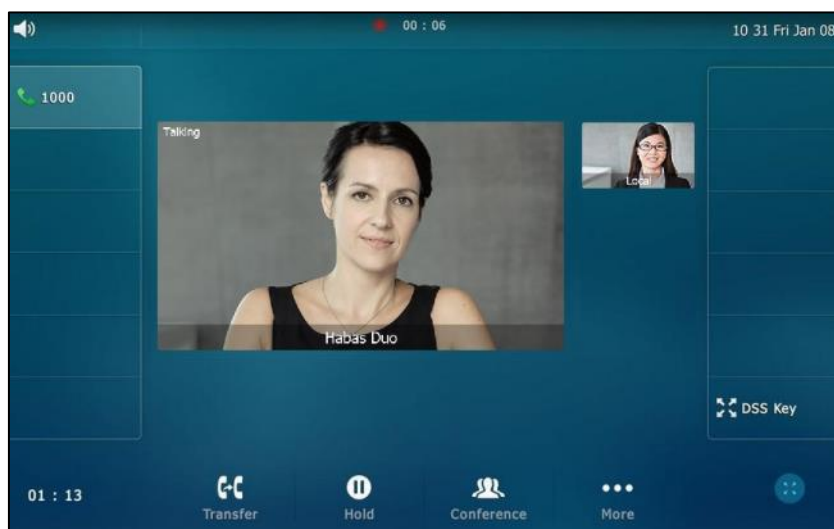

If you tap the **Hold** soft key while recording, only you are recorded. If you press  while recording, only the callee is recorded.

Note

You can hold, transfer or set up a conference call while recording.

When you end a call while recording, the recording will be stopped and saved to USB flash drive automatically.

To stop recording while the phone records, do one of the following:

- Tap the **More** soft key and then tap **Stop** during a call.



The status bar prompts "Call has been recorded on USB device successfully."

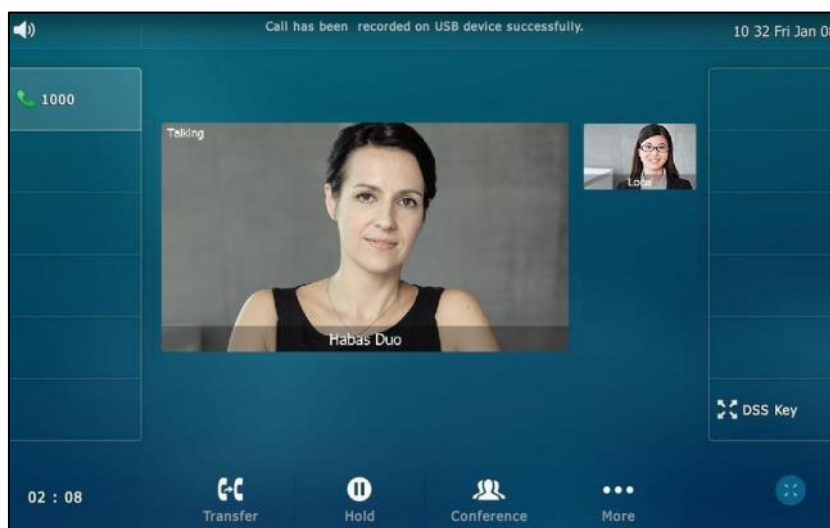

- When there is only a call on the phone, tap the **More** soft key and then tap the **EndCall** soft key.

The LCD screen prompts “Call has been recorded on USB device successfully”, the recording icon and recording duration disappear, and the phone returns to the idle screen.

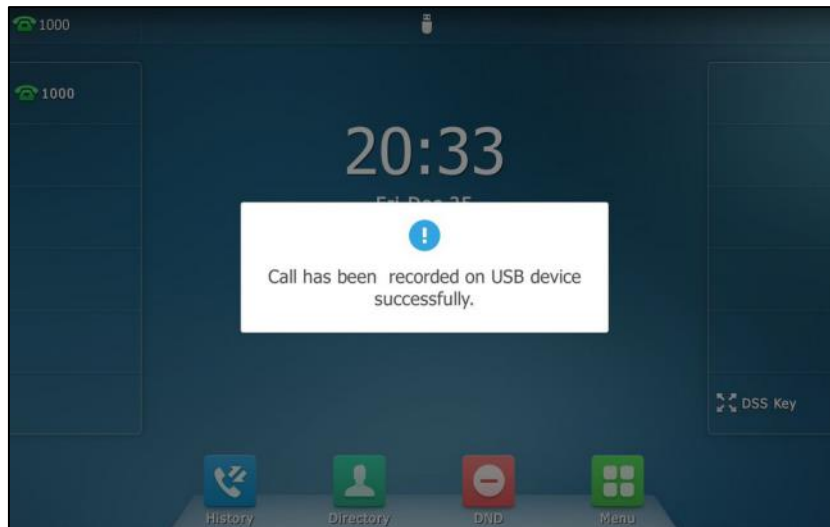

The recording will be stored as a new file on the USB flash drive when the phone starts recording again.

Conference Recording

You can record conference calls in the same way as other calls with the following exceptions:

- All conference participants are recorded while recording. If one of the participants taps the **Hold** soft key, only that participant is recorded. When a conference call is placed on hold, recording of the conference is paused. You can place or answer other calls, which will be recorded in the same file. When the conference call is resumed, recording of the conference resumes.
- All conference participants are recorded while recording. If one of the participants presses , only that participant is not recorded.

Recorded Calls Playback

If you insert a USB flash drive into the USB port on your phone, you can play back recorded calls on your phone.

You can also browse and delete the recorded files on the USB flash drive.

Note

Playback can occur on either the phone itself or on a computer using an application capable of playing *.mkv and *.aac files.

To browse the recorded audio-only files via phone user interface:

1. Tap  ->USB->**Browse Audio**.



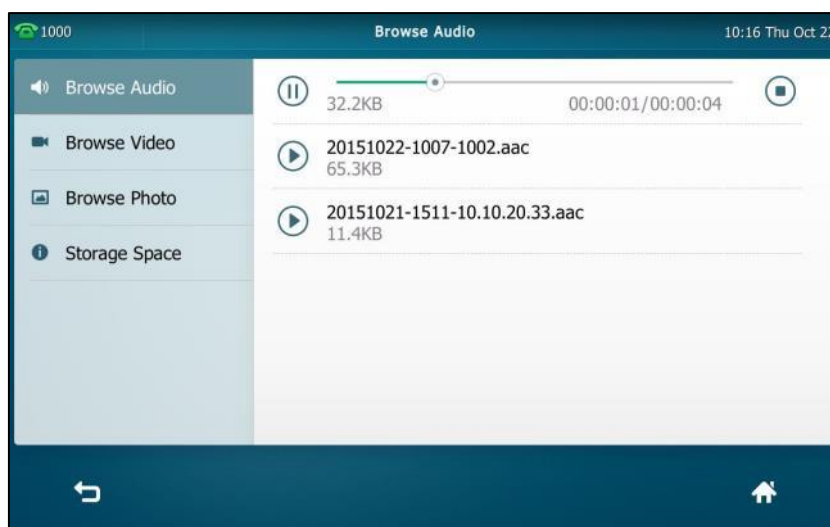

The touch screen shows all recorded audio files in the **Browse Audio** list. The filename consists of the recording time & date, the other party's number/IP address/name (or the first person's number/IP address/name you called).

2. Drag to scroll through the recorded files if required.
3. Tap the desired audio or  to play.

The touch screen shows the recording duration and the size of the recorded file.



During the recording playback, you can do the following:

- Tap  to pause the playback. Then  appears on the touch screen. To continue the playback, tap .
- Drag the slider to skip forward the playback or rewind the playback.
- Press  to adjust the volume of the speakerphone.
- Tap  to stop the playback.

To browse the recorded video files via phone user interface:

1. Tap  ->USB->**Browse Video**.

The touch screen shows all recorded video files in the **Browse Video** list. The filename consists of the recording time & date, the other party's number/IP address/name (or the first person's number/IP address/name you called).

2. Drag to scroll through the recorded files if required.
3. Tap the desired video or  to play the video.

The touch screen shows the recording duration of the recorded file.

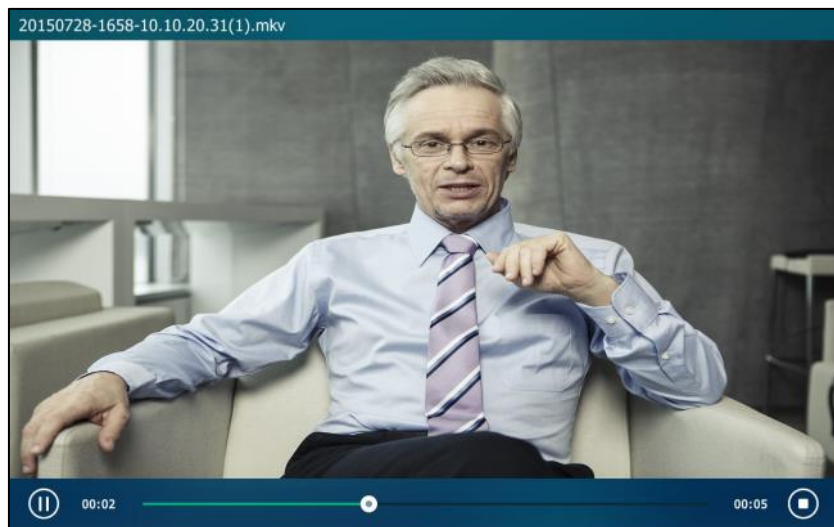

During the recording playback, you can do the following:

- Tap to pause the playback. Then appears on the touch screen. To continue the playback, tap .
- Drag the slider to skip forward the playback or rewind the playback.
- Press to adjust the volume of the speakerphone.
- Tap to stop the playback. The phone returns to the **Browse Video** screen.

If you are playing back a recorded call and an incoming call arrives on your phone, the playback pauses and the phone rings.

To delete a recorded file:

1. Tap ->USB.
2. Do one of the following:
 - Tap **Browse Audio**. Tap after the audio recording you want to delete. (Drag to scroll through the recorded audio files if required.)

The phone prompts “Delete this audio?”.

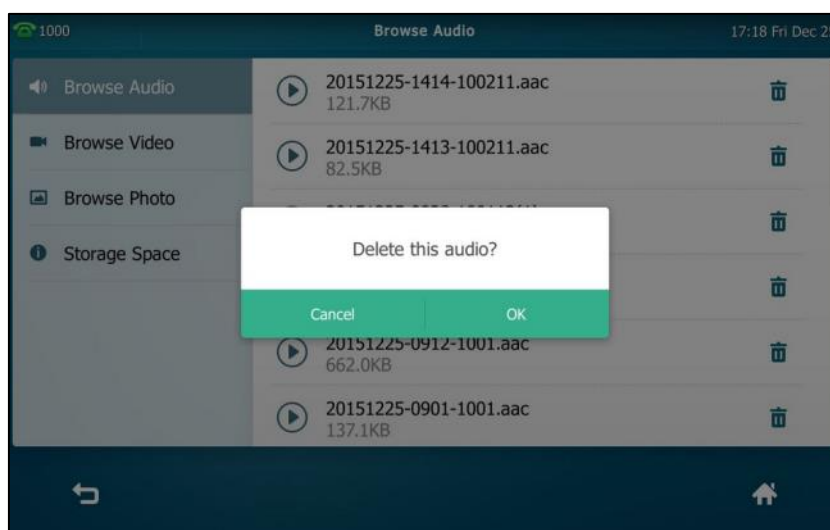

- Tap **Browse Video**.

Tap  after the video recording you want to delete. (Drag to scroll through the recorded video files if required.)

The phone prompts “Delete this video?”.

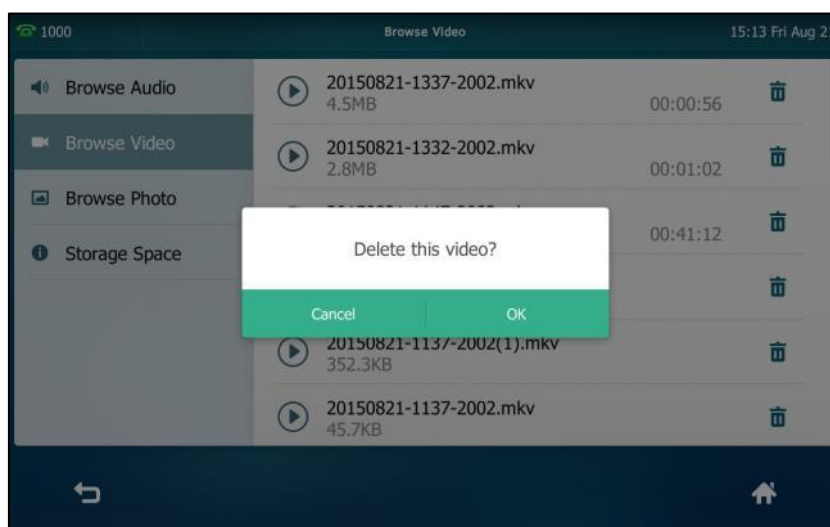

3. Tap **OK** to accept the change or **Cancel** to cancel.

Storage Space

You can check the storage space of the USB flash drive on the IP phone. And if you want to record active call or conference using a USB flash drive, there must be enough free space (greater than 2 minutes) on the USB flash drive.

To check the storage space of the USB flash drive via phone user interface:

1. Tap  ->USB->Storage Space.



Call Recording Using a Record Key

You can record calls by tapping a record key on the phone. The SIP VP-T49G IP phone supports record and URL record.

Two ways of call recording:

- **Record:** The phone sends a SIP INFO message containing a specific header "Record: on/off" to trigger a recording.
- **URL Record:** The phone sends an HTTP URL request to trigger a recording. Contact your system administrator for the predefined URL.

Note

If you record a call using a USB flash drive, the recorded file will be stored in the USB flash drive. For more information, refer to [Call and Conference Recording Using a USB Flash Drive](#) on page 232.

Before recording any call, especially those involving PSTN, it is necessary to know about the rules and restrictions of any governing call-recording in the place you are in. It is also very important to have the consent of the person you are calling before recording the conversation.

Call recording is not available on all servers. Contact your system administrator for more information.

To configure a record key via phone user interface:

1. Tap  ->Features->DSS Keys.
2. Tap the desired line key.
3. Tap the **Type** field.

4. Tap **Key Event** in the pop-up dialog box.
5. Tap the **Key Type** field.
6. Tap **Record** in the pop-up dialog box.
7. (Optional.) Enter the string that will appear on the touch screen in the **Label** field.

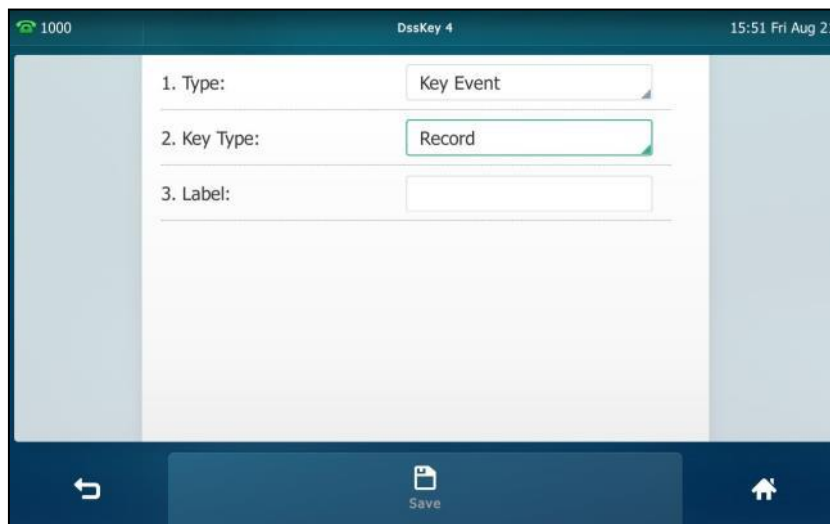

8. Tap the **Save** soft key to accept the change or  to cancel.

To configure a URL record key via phone user interface:

1. Tap  -> **Features**-> **DSS Keys**.
2. Tap the desired line key.
3. Tap the **Type** field.
4. Tap **URL Record** in the pop-up dialog box.
5. (Optional.) Enter the string that will appear on the touch screen in the **Label** field.
6. Enter the URL (e.g., `http://10.1.2.224/phonerecording.cgi`) in the **URL Record** field.

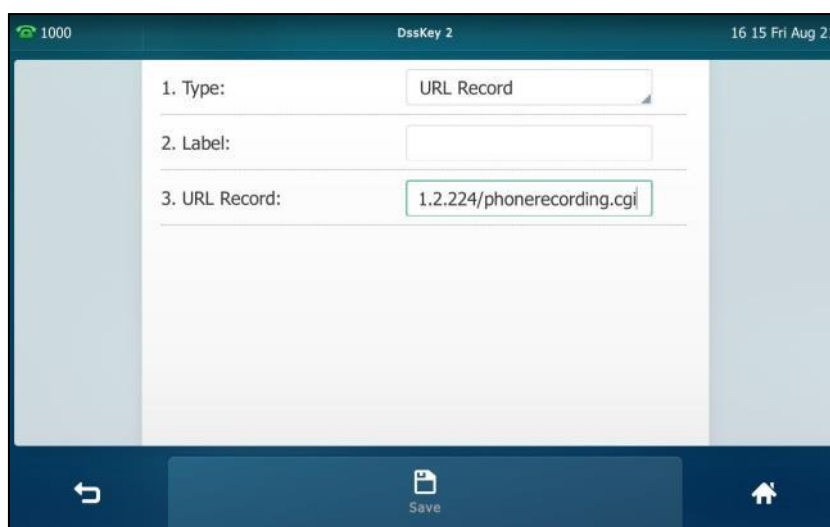

7. Tap the **Save** soft key to accept the change or  to cancel.

Record and URL record keys are configurable via web user interface at the path **DSSKey->Line Key**.

The Record and URL Record keys control the recording function, and are available:

- During an active call
- When calls are on hold or muted
- During a blind or attended transfer
- During a conference call

The Record and URL Record keys are not available when:

- There are no connected calls on your phone
- You place a new call

To record a call:





1. Tap the Record key or URL Record key during a call.

If the recording starts successfully, the recording icon will appear at the bottom right corner of the contact avatar and the icon indicators of the Record key or URL Record key changes to .

2. Tap the Record key or URL Record key again to stop recording.

The recording icon disappears from the bottom right corner of the contact avatar and the icon indicators of the Record key or URL Record key changes to .

Recording status indications you need to know:

Circumstance	Icons on the touch screen
A recording is started	 appears on the touch screen
A recording cannot be started	 appears for 1 second
A recording cannot be stopped	 appears for 1 second, then goes back
The recording box is full	 appears for 1 second
The call cannot be recorded	 appears for 1 second

You can listen to the recordings stored on your server system. For example, you can dial an access code to listen to the recordings.

Note

The way in which you listen to the recordings may be different depending on the server. Contact your system administrator for more information.

Hot Desking

Hot desking originates from the definition of being the temporary physical occupant of

a work station or surface by a particular employee. A primary motivation for hot desking is cost reduction. This feature is regularly used in places where not all the employees are in the office at the same time, or not in the office for very long, which means that actual personal offices would be often vacant, consuming valuable space and resources.

You can use hot desking on the SIP VPT49G IP phone to log out of existing accounts and then log into a new account. As a result, many users can share the phone resource at different times. To use this feature, you need to configure a hot desking key in advance.

Note

Hot desking is not available on all servers. Contact your system administrator for more information.

To configure a hot desking key via phone user interface:

1. Tap  -> **Features**-> **DSS Keys**.
2. Tap the desired line key.
3. Tap the **Type** field.
4. Tap **Key Event** in the pop-up dialog box.
5. Tap the **Key Type** field.
6. Tap **Hot Desking** in the pop-up dialog box.
7. (Optional.) Enter the string that will appear on the touch screen in the **Label** field.

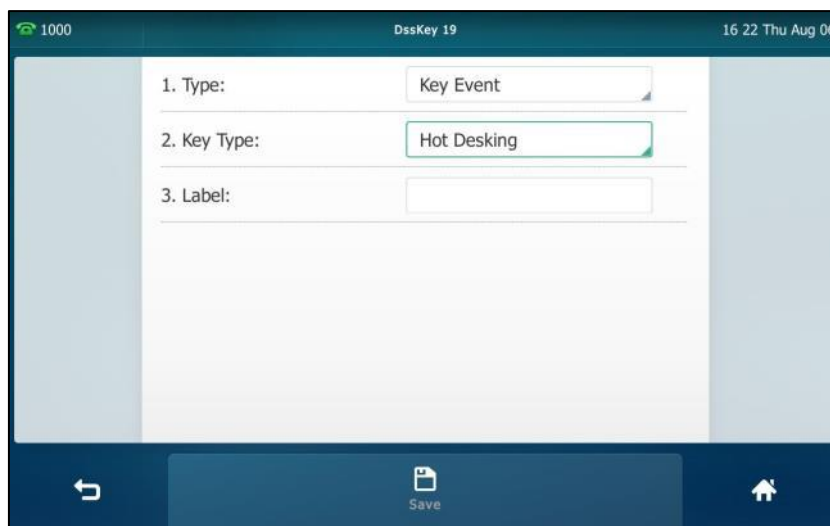

8. Tap the **Save** soft key to accept the change or  to cancel.

Hot desking key is configurable via web user interface at the path **DSSKey->Line Key**.

To use hot desking:

1. Tap the hot desking key when the phone is idle.
The touch screen prompts the following warning:

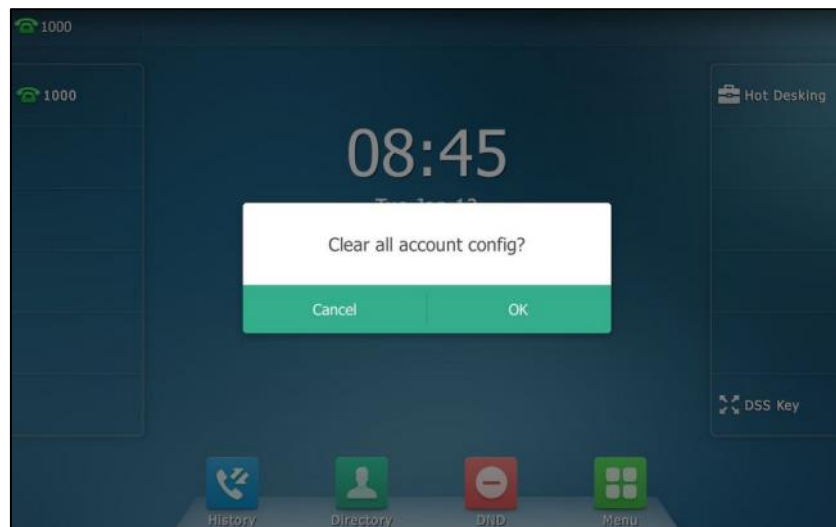

2. Tap **OK**.
Registration configurations of all accounts on the phone will be cleared immediately.
The login wizard will be displayed as below:

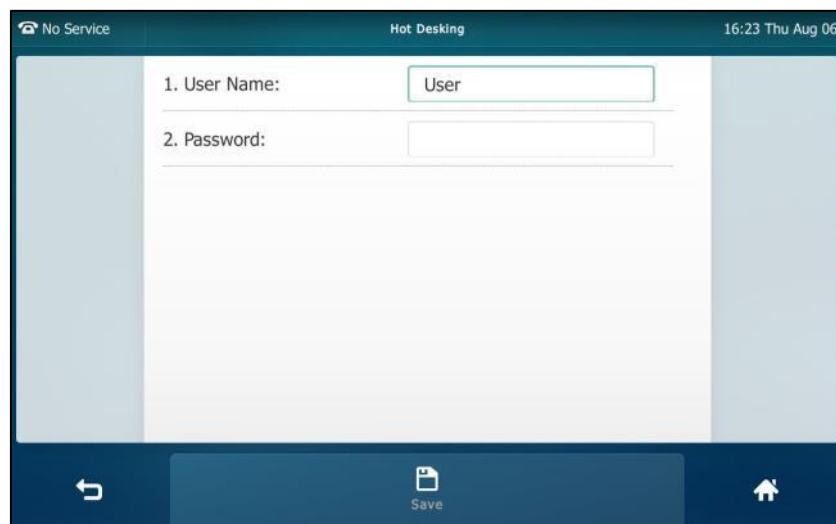

3. Enter the login information in each field.
4. Tap the **Save** soft key to login or  to cancel.

Intercom

Intercom is a useful feature in an office environment to quickly connect with the operator or the secretary. You can tap the intercom key to automatically connect with a preconfigured target extension for outgoing intercom calls, and the target extension will

automatically answer incoming intercom calls by default.

Note Intercom is not available on all servers. Contact your system administrator for more information.

Outgoing Intercom Calls

To configure an intercom key via phone user interface:

1. Tap  -> **Features**->**DSS Keys**.
2. Tap the desired line key.
3. Tap the **Type** field.
4. Tap **Intercom** in the pop-up dialog box.
5. Tap the **Account ID** field.
6. Tap the desired line in the pop-up dialog box.
7. (Optional.) Enter the string that will appear on the touch screen in the **Label** field.
8. Enter the target extension number in the **Value** field.

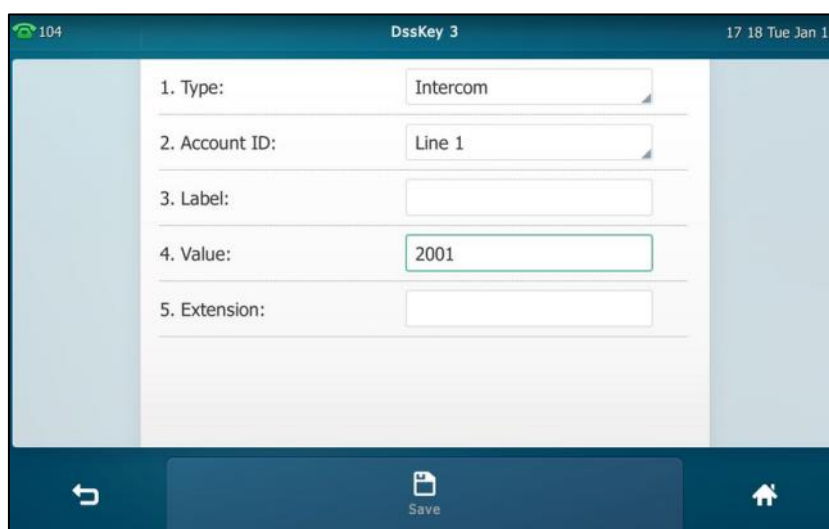

The screenshot shows the 'DssKey 3' configuration screen. The top status bar displays '104' on the left and '17 18 Tue Jan 12' on the right. The main form contains the following fields:

- 1. Type: Intercom
- 2. Account ID: Line 1
- 3. Label: (empty)
- 4. Value: 2001
- 5. Extension: (empty)

At the bottom of the screen, there are three soft keys: a back arrow, a 'Save' button with a floppy disk icon, and a home button with a house icon.

9. Tap the **Save** soft key to accept the change or  to cancel.

Intercom key is configurable via web user interface at the path **DSSKey->Line Key**.

Incoming Intercom Calls

The SIP VPT49G IP phone supports automatically answering an incoming intercom call by default. The phone automatically plays a warning tone when it receives an incoming intercom call. In addition, you can enable the phone to mute the microphone when it automatically answers an incoming intercom call. You can also enable the phone to

automatically answer an incoming intercom call while there is already an active call on the phone. The active call is then placed on hold.

Intercom features you need to know:

Intercom Feature	Description
Accept Intercom	Enable or disable the IP phone to automatically answer an incoming intercom call.
Intercom Mute	Enable or disable the IP phone's microphone for intercom calls.
Intercom Tone	Enable or disable the IP phone to play a warning tone when it receives an incoming intercom call.
Intercom Barge	Enable or disable the IP phone to automatically answer an incoming intercom call while there is already an active call on the phone.

Accept Intercom

You can enable or disable the phone to automatically answer an incoming intercom call. If Accept Intercom is enabled, the phone will automatically answer an incoming intercom call. If Accept Intercom is disabled, the phone will reject incoming intercom calls and send a busy message to the caller. Accept Intercom is enabled by default.

Note

Your administrator can set a period of delay time before the phone automatically answers intercom calls. Contact your system administrator for more information.

Intercom Mute

You can mute or un-mute the phone's microphone for intercom calls automatically. If Intercom Mute is enabled, the microphone will be muted for intercom calls. If Intercom Mute is disabled, the microphone will work for intercom calls. Intercom Mute is disabled by default.

Intercom Tone

You can enable or disable the phone to play a warning tone when receiving an intercom call. If Intercom Tone is enabled, the phone will play a warning tone before answering the intercom call. If Intercom Tone is disabled, the phone will automatically answer the intercom call without warning. Intercom Tone is enabled by default.

Intercom Barge

You can enable or disable the phone to automatically answer an incoming intercom call while there is already an active call on the phone. If Intercom Barge is enabled, the phone will automatically answer the intercom call and place the active call on hold. If Intercom Barge is disabled, the phone will handle an incoming intercom call like a waiting call. Intercom Barge is disabled by default.

Note

To enable the phone to receive a new incoming call when it has an active call, make sure that call waiting feature is enabled on the phone in advance. For more information, refer to [Call Waiting](#) on page 205.

To configure intercom features via phone user interface:

1. Tap  -> **Features**-> **Intercom**.
2. Make the desired changes.

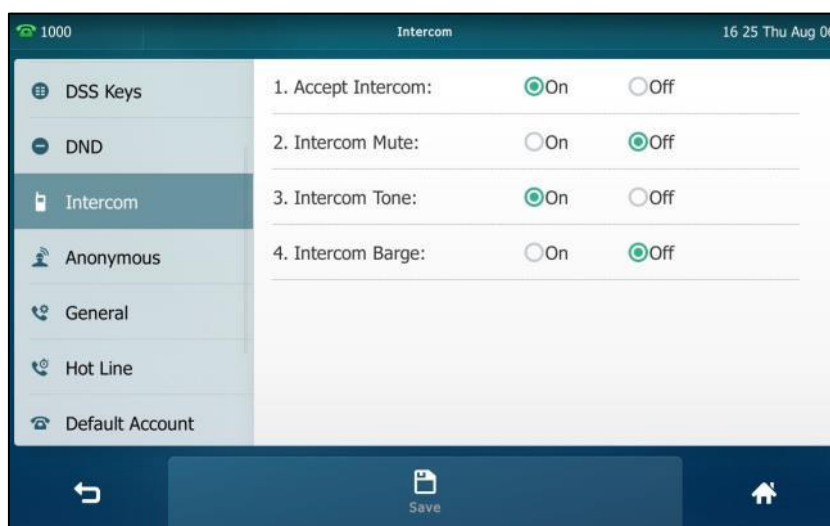

3. Tap the **Save** soft key to accept the change or  to cancel.

These specific parameters are configurable via web user interface at the path **Features->Intercom**.

Using Intercom

To place an intercom call when the target phone is idle:

1. Tap the intercom key when the phone is idle.
The called destination plays a warning tone and automatically answers the call in the speakerphone mode by default.
2. To end the intercom call, tap the intercom key again or the **EndCall** soft key.

Multicast Paging

You can use multicast paging to quickly and easily broadcast time sensitive announcements out to people who are listening to a specific multicast group. You can configure a multicast paging key or a paging list key on the phone, which allows you to send a Real Time Transport Protocol (RTP) stream to the pre-configured multicast address(es) without involving SIP signaling. You can configure the phone to receive an RTP stream from pre-configured multicast listening address(es) without involving SIP signaling. You can specify up to 10 multicast listening addresses.

Sending RTP Stream

To configure a multicast paging key via phone user interface:

1. Tap  -> **Features**->**DSS Keys**.
2. Tap the desired line key.
3. Tap the **Type** field.
4. Tap **Key Event** in the pop-up dialog box.
5. Tap the **Key Type** field.
6. Tap **Multicast Paging** in the pop-up dialog box.
7. (Optional.) Enter the string that will appear on the touch screen in the **Label** field.
8. Enter the multicast IP address and port number (e.g., 224.5.6.20:10008) in the **Value** field.

The valid multicast IP addresses range from 224.0.0.0 to 239.255.255.255.

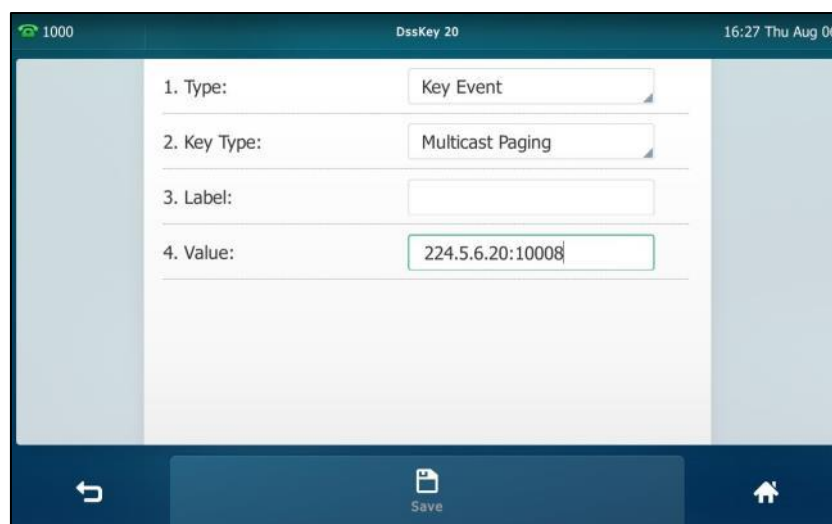



9. Tap the **Save** soft key to accept the change or  to cancel.

Multicast paging key is configurable via web user interface at the path **DSSKey->Line Key**.

To configure a paging list key via phone user interface:

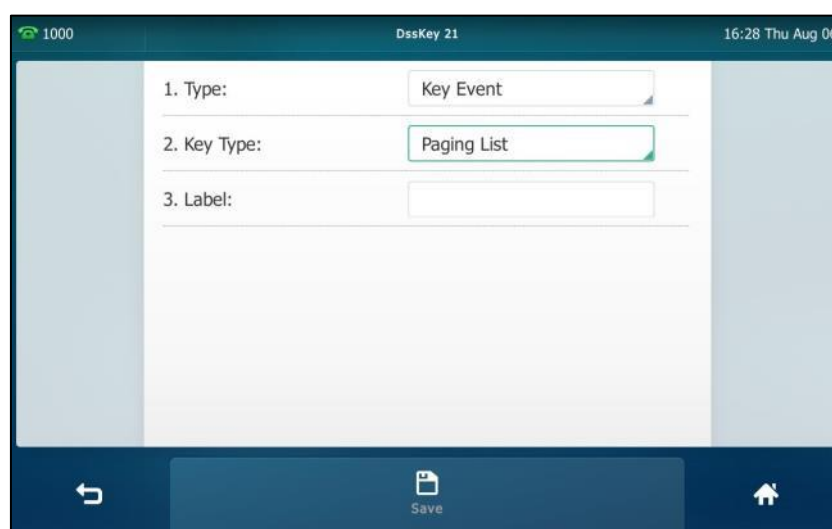
1. Tap  -> **Features**->**DSS Keys**.
2. Tap the desired line key.
3. Tap the **Type** field.
4. Tap **Key Event** in the pop-up dialog box.
5. Tap the **Key Type** field.
6. Tap **Paging List** in the pop-up dialog box.
7. (Optional.) Enter the string that will appear on the touch screen in the **Label** field.



8. Tap the **Save** soft key to accept the change or  to cancel.

Paging list key is configurable via web user interface at the path **DSSKey->Line Key**.

To configure paging list via phone user interface:

1. Tap the paging list key when the phone is idle.
2. Tap a desired paging group.

The default tag is Empty if it is not configured before.



3. Tap the **Edit** soft key.

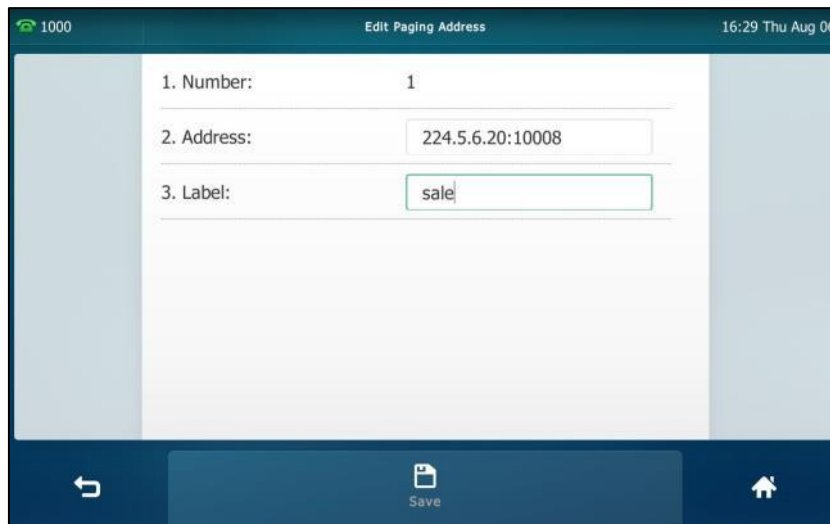

4. Enter the multicast IP address and port number (e.g., 224.5.6.20:10008) in the **Address** field.
The valid multicast IP addresses range from 224.0.0.0 to 239.255.255.255.
5. Enter the paging group name in the **Label** field.
6. Tap the **Save** soft key to accept the change.
7. Repeat steps 2 to 6, you can add more paging groups.

Paging list is configurable via web user interface at the path **Directory->Multicast IP**.

To delete paging group via phone user interface:

1. Tap the paging list key when the phone is idle.
2. Tap a desired paging group.

3. Tap the **Delete** soft key.

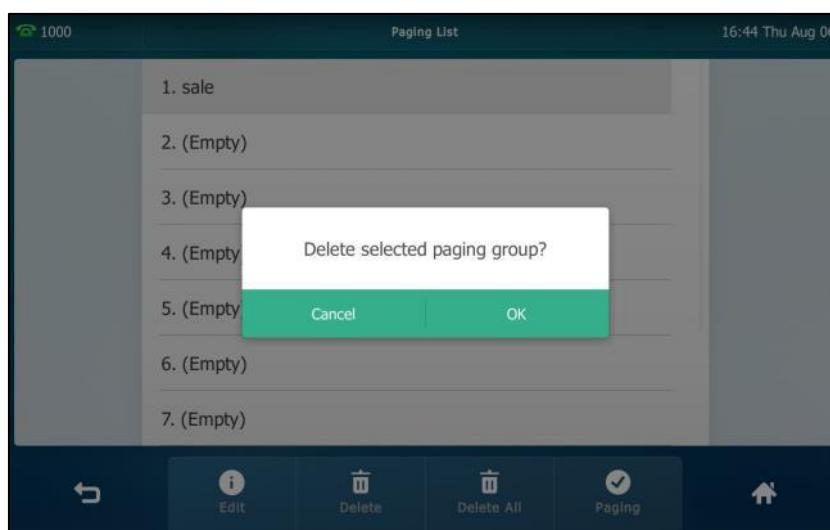

4. Tap **OK** to accept the change or **Cancel** to cancel.

If you want to delete all paging groups, you can tap the **Delete All** soft key.

You can also configure the phone to use a default codec for sending multicast RTP stream via web user interface.

To configure a default codec for multicast paging via web user interface:

1. Click on **Features->General Information**.
2. Select the desired codec from the pull-down list of **Multicast Codec**.

The default codec is G722.

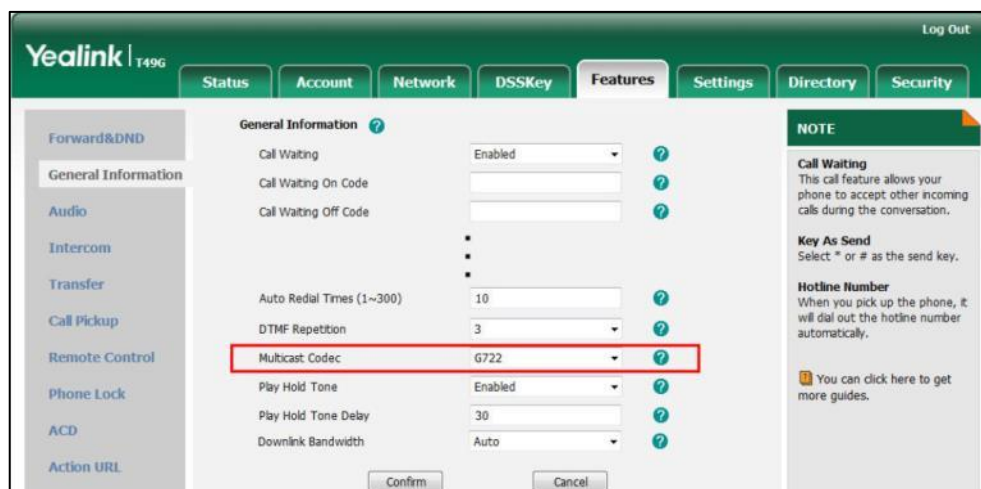

3. Click **Confirm** to accept the change.

Note If G722 codec is used for multicast paging, the touch screen will display the icon **HD** to indicate that it is providing high definition voice.

Default codec for multicast paging is configurable via web user interface only.

Receiving RTP Stream

You can configure the phone to receive a Real Time Transport Protocol (RTP) stream from the pre-configured multicast address(es) without involving SIP signaling. You can specify up to 10 multicast addresses that the phone listens to on the network.

How the phone handles incoming multicast paging calls depends on Paging Barge and Paging Priority Active parameters configured via web user interface.

Paging Barge

The paging barge parameter defines the priority of the voice call in progress. If the priority of an incoming multicast paging call is lower than that of the active call, it will be ignored automatically. If Disabled is selected from the pull-down list of Paging Barge, the voice call in progress will take precedence over all incoming multicast paging calls. Valid values in the Paging Barge field:

- **1 to 10:** Define the priority of the active call, 1 with the highest priority, 10 with the lowest.
- **Disabled:** The voice call in progress will take precedence over all incoming paging calls.

Paging Priority Active

The paging priority active parameter decides how the phone handles incoming multicast paging calls when there is already a multicast paging call on the phone. If enabled, the phone will ignore incoming multicast paging calls with lower priorities, otherwise, the phone will answer incoming multicast paging calls automatically and place the previous multicast paging call on hold. If disabled, the phone will automatically ignore all incoming multicast paging calls.

To configure multicast listening addresses via web user interface:

1. Click on **Directory->Multicast IP**.
2. Select the desired value from the pull-down list of **Paging Barge**.
3. Select the desired value from the pull-down list of **Paging Priority Active**.
4. Enter the multicast IP address(es) and port number (e.g., 224.5.6.20:10008) which the phone listens to for incoming RTP multicast in the **Listening Address** field.
5. Enter the label in the **Label** field.

Label will appear on the touch screen when receiving the multicast RTP stream.

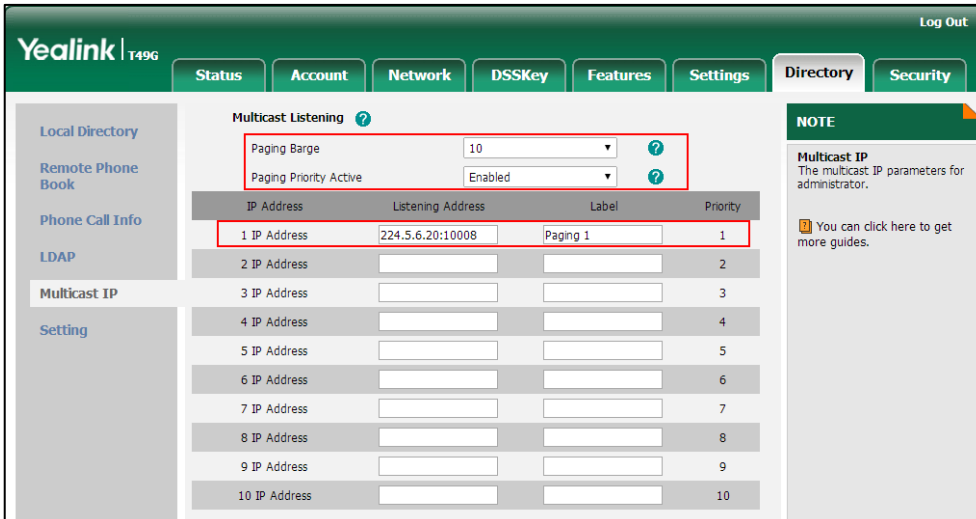

Multicast Listening

Paging Barge: 10

Paging Priority Active: Enabled

IP Address	Listening Address	Label	Priority
1 IP Address	224.5.6.20:10008	Paging 1	1
2 IP Address			2
3 IP Address			3
4 IP Address			4
5 IP Address			5
6 IP Address			6
7 IP Address			7
8 IP Address			8
9 IP Address			9
10 IP Address			10

NOTE
Multicast IP
The multicast IP parameters for administrator.
You can click here to get more guides.

- Click **Confirm** to accept the change.

Note The priorities of listening addresses are predefined: 1 with the highest priority, 10 with the lowest.
Multicast listening addresses are configurable via web user interface only.

Using Multicast Paging

To send RTP stream via a multicast paging key when the receiver's phone is idle:

- Tap the multicast paging key when the phone is idle.
The phone sends RTP to a preconfigured multicast address (IP: Port).
Both the sender's and receiver's phones play a warning tone and the receiver automatically answers the multicast RTP session in the speakerphone mode.
The multicast paging key icon indicator will become  and solid.

The following figure shows a multicast RTP session on the phone:

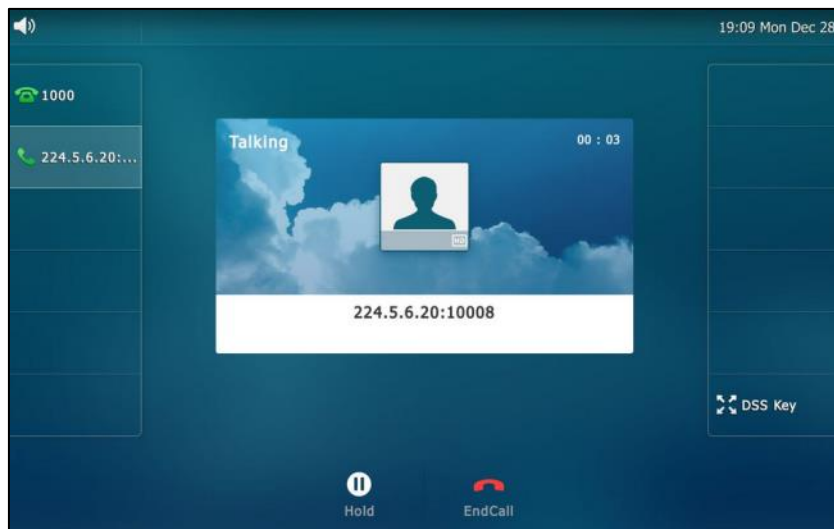

2. You can do the following:

- Tap the **Hold** soft key to place the current multicast RTP session on hold. The sender's phone places the multicast RTP session on hold and receiver's phone releases the session. To resume the held multicast RTP session, tap the **Resume** soft key. The multicast RTP session is established again.
- Tap the **EndCall** soft key to cancel the multicast RTP session.

Note

Multicast RTP is one way only from the sender to the multicast address(es) (receiver). For outgoing RTP multicasts, all other existing calls on the phone will be placed on hold.

To send RTP stream via a paging key list when the receiver's phone is idle:

1. Tap paging list key when the phone is idle.

2. Tap the desired paging group.

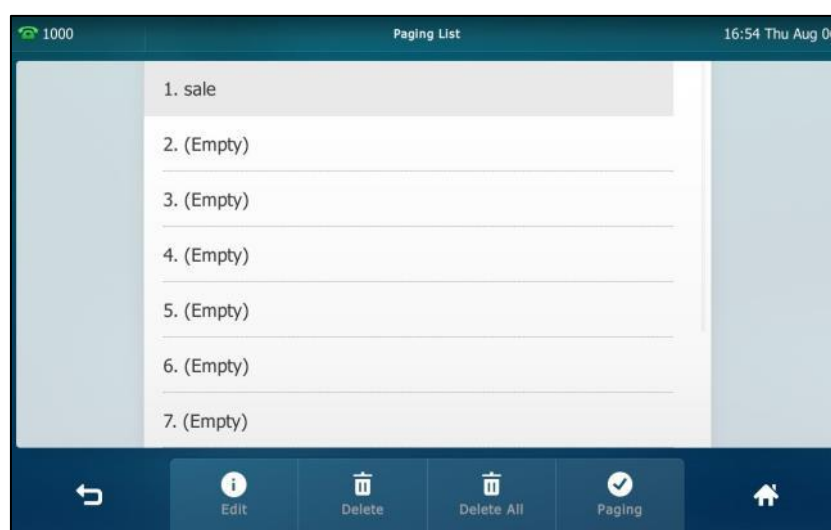

3. Tap the **Paging** soft key to send RTP.
4. You can do the following:
 - Tap the **Hold** soft key to place the current multicast RTP session on hold. The sender's phone places the multicast RTP session on hold and receiver's phone releases the session. To resume the held multicast RTP session, tap the **Resume** soft key. The multicast RTP session is established again.
 - Tap the **EndCall** soft key to cancel the multicast RTP session.

Music on Hold

Music on hold (MoH) is the business practice of playing recorded music to fill the silence that would be heard by the party placed on hold. To use this feature, you should specify a SIP URI pointing to a Music on Hold Server account. When a call is placed on hold, the phone will send a SIP INVITE message to the Music on Hold Server account. The Music on Hold Server account automatically answers the SIP INVITE messages and immediately plays audio from some source located anywhere (LAN, Internet) to the held party. Contact your system administrator for the SIP URI.

To configure music on hold server via web user interface:

1. Click on **Account->Advanced**.
2. Select the desired account from the pull-down list of **Account**.

- Enter the SIP URI (e.g., sip:moh@sip.com) in the **Music Server URI** field.

The screenshot shows the Yealink T49G web interface with the 'Account' tab selected. The 'Account' section is expanded, showing various configuration fields. The 'Music Server URI' field is highlighted with a red box and contains the value 'sip:moh@sip.com'. Other fields include 'Keep Alive Type', 'Keep Alive Interval(Seconds)', 'RPort', 'Subscribe Period(Seconds)', 'DTMF Type', 'ACD Subscribe Period(120~3600s)', 'Early Media', 'SIP Server Type', 'Directed Call Pickup Code', 'Out Dialog BLF', 'VQ RTCP-XR Collector name', 'VQ RTCP-XR Collector address', and 'VQ RTCP-XR Collector port'. A 'NOTE' section on the right indicates that advanced parameters are for administrators and provides a link to more guides.

- Click **Confirm** to accept the change.

When you place a call on hold, music will be played to the held party.

Note

For this feature to function, all involved parties cannot use encrypted RTP (SRTP).
Music on hold server is configurable via web user interface only.

Automatic Call Distribution (ACD)

ACD is often used in offices for customer service, such as call center. The ACD system handles large volumes of incoming calls from callers who have no need to talk to a specific person but who require assistance from any of multiple persons at the earliest opportunity. ACD on the SIP VP-T49G IP phone allows the ACD system to distribute large volumes of incoming calls to the registered ACD users. To use this feature, you should configure an ACD key in advance. For more information on ACD key icon indicator, refer to [Icon Instructions](#) on page 15.

Note

Make sure ACD is enabled on your IP phone. For more information on enabling ACD, contact your system administrator.

To configure an ACD key via phone user interface:

- Tap  -> **Features**->**DSS Keys**.
- Tap the desired line key.
- Tap the **Type** field.
- Tap **ACD** in the pop-up dialog box.

- (Optional.) Enter the string that will appear on the touch screen in the **Label** field.

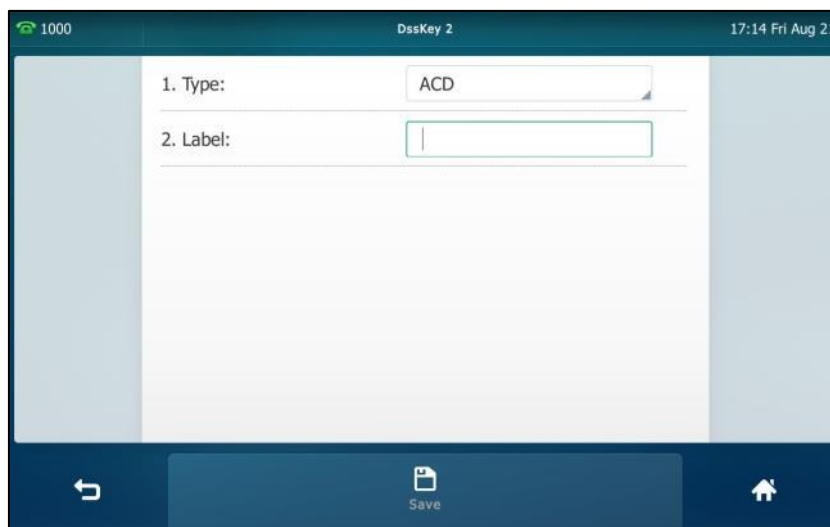

- Tap the **Save** soft key to accept the change or  to cancel.

ACD key is configurable via web user interface at the path **DSSKey->Line Key**.

To log into the ACD system:

- Tap the ACD key when the phone is idle.

The touch screen prompts you the following information:

User ID: the identity used to log into the queue.

Password: the password used to log into the queue.

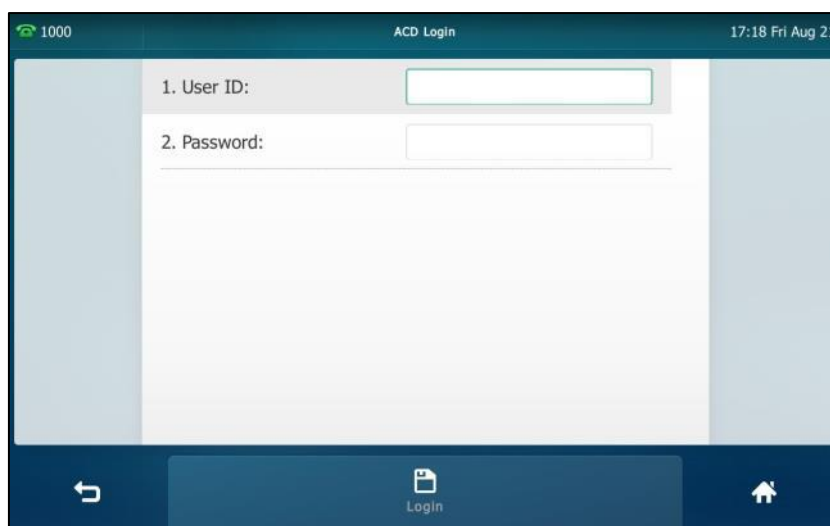

- Tap the **Login** soft key to log in.

Note

Contact your system administrator for the User ID and Password to access the ACD system.

After configuring an ACD key, you can tap the ACD key to log into the ACD system. After

logging in, you are ready to receive calls from the ACD system. You can tap the ACD key to show your current ACD user status. You can tap **Available/Unavailable** to change your ACD user status. ACD user status synchronizes on both IP phone and ACD system.

When you set the ACD user status to be available, the ACD key icon indicator will become  and solid, and then the server begins distributing calls to your phone.

When you set the ACD user status to be unavailable, the ACD key icon indicator will become  and flashing, and then the server temporarily stops distributing calls to your phone. To log out of the ACD system, tap **Logout**.

Note

It is recommended you configure no more than one ACD key per phone. At any time, at most one ACD key can be in progress on your phone.

Shared Call Appearance (SCA)

You can use SCA feature to share an extension which can be registered on two or more IP phones at the same time. The shared line is indicated by a different line icon.

In the following figure, the first line is shared and the second line is private:

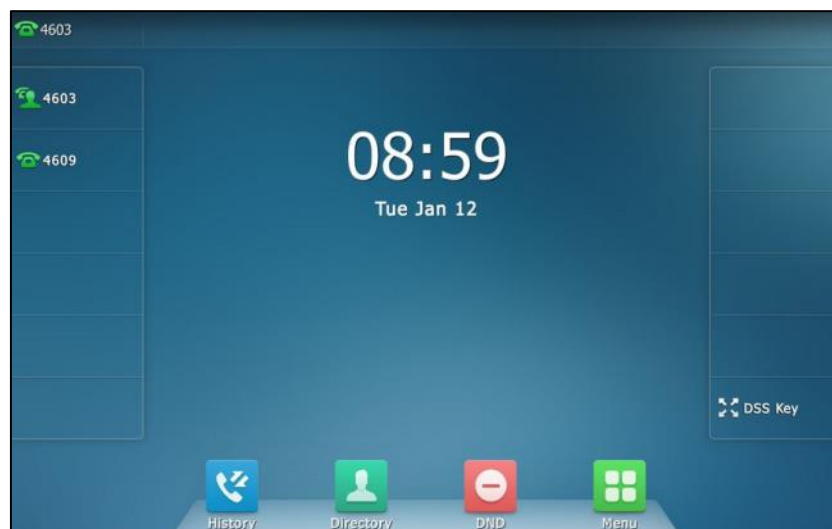

If two phones share a line, an incoming call to this extension will cause both phones to ring simultaneously. The incoming call can be answered on either phone but not both. This feature is very useful in the boss and secretary scenario. For example, the secretary can share the boss's extension on her phone. When there is an incoming call to the extension of the boss, both the phones of the boss and the secretary will ring simultaneously. Either the boss or the secretary can answer the call. Calls on the shared line can be placed on hold, barged in or retrieved from another shared phone.

Configuring SCA Feature on the IP Phone

You can configure a primary account on the IP phone and other alternate accounts on the other IP phones. In a SCA Hybrid Key System scenario, you can automatically assign multiple DSS keys with Line type for a registered shared line on the phone (If auto linekeys feature is enabled). For example, party A, party B share the account 4603, phone A registers the primary account 4603 and assigns line key 1 and line key 2 for the account 4603, phone B registers the alternate account 4603_1 and assigns line key 1 and line key 2 for the account 4603_1, phone C registers the account 4604.

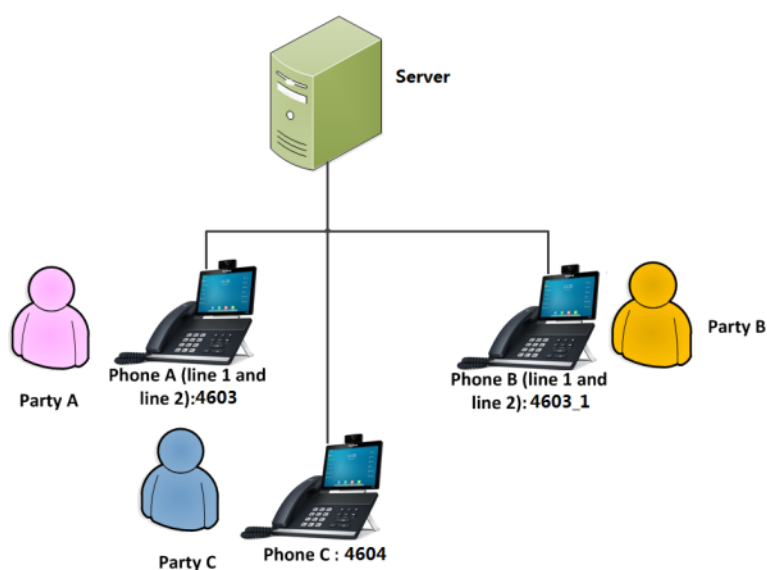

To configure the auto linekeys feature via web user interface:

1. Click on **Features->General Information**.
2. Select **Enabled** from the pull-down list of **Auto LineKeys**.

If **Auto LineKeys** is enabled, you can automatically assign multiple DSS keys with Line type for a registered shared line on the phone.

The screenshot shows the Yealink T49G web interface. The 'Features' tab is selected, and the 'General Information' section is expanded. The 'Auto Linekeys' option is set to 'Enabled' and is highlighted with a red box. Other settings include 'Call Waiting' (Enabled), 'Auto Redial' (Disabled), and 'Display Method on Dialing' (User Name). A 'NOTE' section on the right provides information about 'Call Waiting', 'Key As Send', and 'Hotline Number'.

Feature	Value
Call Waiting	Enabled
Call Waiting On Code	
Call Waiting Off Code	
Auto Redial	Disabled
Auto Redial Interval (1~300s)	10
Auto Redial Times (1~300)	10
Key As Send	#
Reserve # in User Name	Enabled
Hotline Number	
Hotline Delay(0~10s)	4
Busy Tone Delay (Seconds)	0
Return Code When Refuse	486 (Busy Here)
Return Code When DND	480 (Temporarily Unava)
Display Method on Dialing	User Name
Auto Linekeys	Enabled

3. Click **Confirm** to accept the change.

To configure the shared line settings and the number of line key on phone A via web user interface:

1. Register the primary account 4603.

The screenshot shows the Yealink VPT49G web interface. The top navigation bar includes 'Status', 'Account', 'Network', 'DSSKey', 'Features', 'Settings', 'Directory', and 'Security'. The 'Account' section is selected, showing 'Account 1' with a status of 'Registered'. The 'Line Active' field is set to 'Enabled'. The 'Outbound Proxy Server 1' field is set to '10.1.8.11'. The 'NOTE' section on the right contains the following information:

Display Name
SIP service subscriber's name which will be used for Caller ID display.

Register Name
SIP service subscriber's ID used for authentication.

User Name
User account, provided by VoIP service provider.

NAT Traversal
Defines the STUN server to be active or not.

2. Click on **Advanced**, and then select **Share Call Appearance** from the pull-down list of **Shared Line**.
3. Enter the desired number in the **Number of line key** field.
This field appears only if **Auto Linekeys** feature is enabled.

The default value is 1. In this example, the value is set to 2.

The screenshot shows the Yealink T49G web interface with the 'Account' tab selected. The 'Account' settings are displayed for 'Account 1'. The 'Number of line key' field is highlighted with a red box and contains the value '2'. Other fields include 'Shared Line' (Share Call Appearance), 'Call Pull Feature Access Code', 'Out Dialog BLF' (Disabled), 'VQ RTPC-XR Collector name', 'VQ RTPC-XR Collector address', and 'VQ RTPC-XR Collector port' (5060). The 'Confirm' and 'Cancel' buttons are visible at the bottom.

Field	Value
Account	Account 1
Keep Alive Type	Default
Keep Alive Interval(Seconds)	30
RPort	Disabled
Subscribe Period(Seconds)	1800
DTMF Type	RFC2833
DTMF Info Type	DTMF-Relay
DTMF Payload Type(96~127)	101
Retransmission	Disabled
Shared Line	Share Call Appearance
Call Pull Feature Access Code	
Out Dialog BLF	Disabled
VQ RTPC-XR Collector name	
VQ RTPC-XR Collector address	
VQ RTPC-XR Collector port	5060
Number of line key	2

4. Click **Confirm** to accept the change.

The phone A will automatically configure the line keys from the first unused DSS key, according to the configured number in the **Number of line key** field.

To configure the shared line settings and the number of line key on phone B via web user interface:

1. Register the alternate account 4603_1.

(Enter the primary account 4603 in the **Register Name** field.)

The screenshot shows the Yealink T49G web interface with the 'Account' configuration page. The 'Advanced' section is expanded, and a red box highlights the 'SIP Server 1' and 'Outbound Proxy Server' fields. The 'Register Name' field is set to '4603'. The 'Outbound Proxy Server 1' field is set to '10.1.8.11'. The 'Enable Outbound Proxy Server' field is set to 'Enabled'. The 'SIP Server 1' section includes fields for Server Host (pbx.yealink.com), Transport (UDP), Server Expires (3600), and Server Retry Counts (3). The 'Outbound Proxy Server' section includes fields for Outbound Proxy Server 1 (10.1.8.11), Outbound Proxy Server 2, Proxy Fallback Interval (3600), and NAT (Disabled). A 'NOTE' section on the right provides information about Display Name, Register Name, User Name, and NAT Traversal.

2. Click on **Advanced**, and then select **Shared Call Appearance** from the pull-down list of **Shared Line**.
3. Enter the desired number in the **Number of line key** field.

This field appears only if **Auto Linekeys** feature is enabled.

The default value is 1. In this example, the value is set to 2.

The screenshot shows the Yealink 1496 web interface with the 'Account' tab selected. The 'Account' configuration page is displayed for 'Account 1'. The 'Number of line key' field is highlighted with a red box and set to '2'. Other fields include 'Keep Alive Type' (Default), 'Keep Alive Interval(Seconds)' (30), 'RPort' (Disabled), 'Subscribe Period(Seconds)' (1800), 'DTMF Type' (RFC2833), 'DTMF Info Type' (DTMF-Relay), 'DTMF Payload Type(96~127)' (101), 'Retransmission' (Disabled), 'Shared Line' (Share Call Appearance), 'Call Pull Feature Access Code', 'Out Dialog BLF' (Disabled), 'VQ RTPC-XR Collector name', 'VQ RTPC-XR Collector address', and 'VQ RTPC-XR Collector port' (5060). A 'NOTE' section on the right states: 'Advanced The Advanced parameters for administrator. You can click here to get more guides.'

4. Click **Confirm** to accept the change.

The phone B will automatically configure the line keys from the first unused DSS key, according to the configured number in the **Number of line key** field.

Configuring Private Hold Soft Key or Private Hold Key

Public hold allows any shared line to retrieve the held call. Private hold only allows the hold party to retrieve the held call. For example, you can retrieve the held call on either phone A or phone B when you place a call on public hold; you can retrieve the held call only on phone A when you place a call on private hold on phone A. By default, the private hold soft key isn't displayed on the touch screen. You need to configure either the private hold soft key or a private hold key before you place the call on private hold.

To configure the private hold soft key via web user interface:

1. Click on **Settings->Softkey Layout**.
2. Select **Enabled** from the pull-down list of **Custom Softkey**.
3. Select **On Talk** from the pull-down list of **Call States**.
4. Select **Private Hold** from the **Unselected Softkeys** column and then click .

The **Private Hold** appears in the **Selected Softkeys** column.

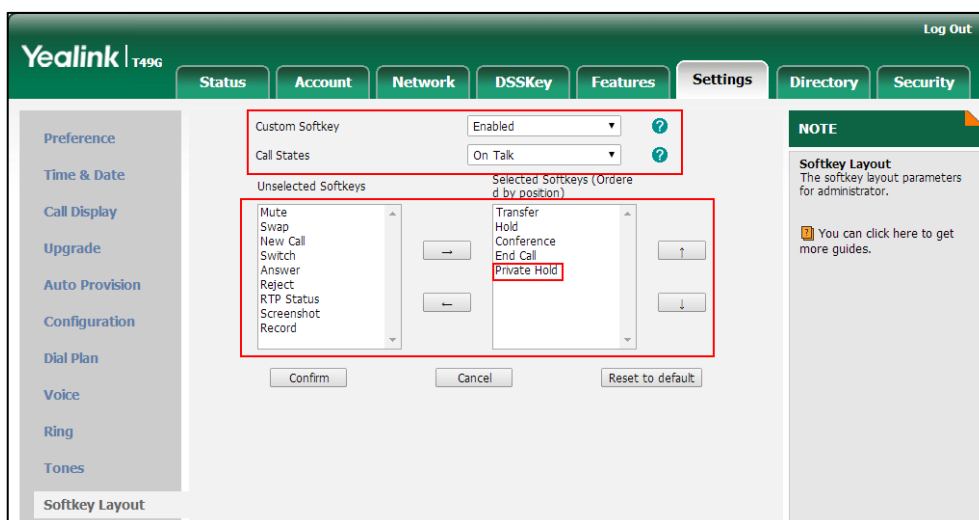

5. Click **Confirm** to accept the change.

Note

Configuring the private hold soft key may affect the softkey layout in the Talking state. Contact your administrator for more information.

To configure a private hold key via phone user interface:

1. Tap -> **Features**->**DSS Keys**.
2. Tap the desired line key.
3. Tap the **Type** field.
4. Tap **Key Event** in the pop-up dialog box.
5. Tap the **Key Type** field.
6. Tap **Private Hold** in the pop-up dialog box.
7. (Optional.) Enter the string that will appear on the touch screen in the **Label** field.

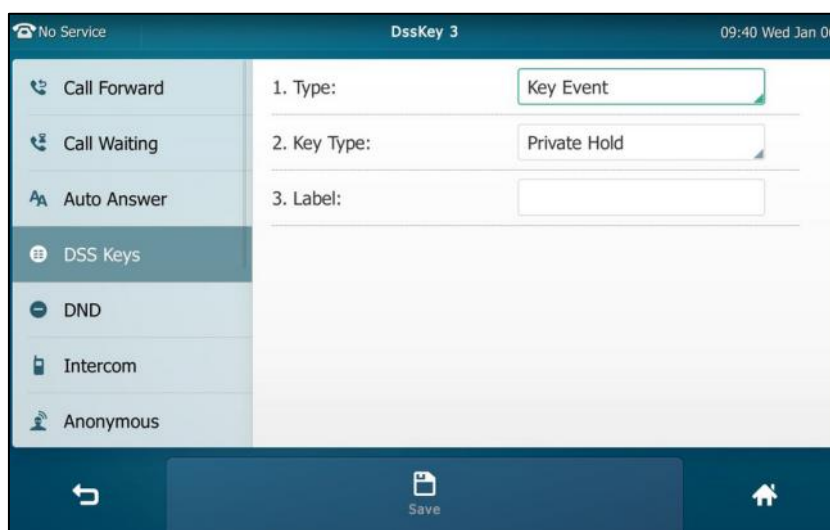

- Tap the **Save** soft key to accept the change or ↶ to cancel.

Configuring Call Pull Feature

Call pull feature allows users to retrieve an existing call from another shared phone that is in active or public hold status.

To configure the call pull feature access code via web user interface:

- Click on **Account->Advanced**.
- Select the desired account from the pull-down list of **Account**.
- Enter the call pull feature access code (e.g., *11) in the **Call Pull Feature Access Code** field.

The screenshot shows the Yealink T49G web interface. The top navigation bar includes 'Status', 'Account', 'Network', 'DSSKey', 'Features', 'Settings', 'Directory', and 'Security'. The 'Account' section is active, showing 'Account 1' selected. The 'Advanced' settings are displayed, including fields for 'Keep Alive Type', 'Keep Alive Interval(Seconds)', 'RPort', 'Subscribe Period(Seconds)', 'DTMF Type', 'DTMF Info Type', 'DTMF Payload Type(96~127)', 'Retransmission', 'Shared Line', 'Call Pull Feature Access Code', 'Dialog Info Call Pickup', 'SIP Send MAC', 'VQ RTPC-XR Collector address', 'VQ RTPC-XR Collector port', and 'Number of line key'. The 'Call Pull Feature Access Code' field is highlighted with a red box and contains the value '*11'. A 'NOTE' box on the right states: 'Advanced: The Advanced parameters for administrator. You can click here to get more guides.' At the bottom, there are 'Confirm' and 'Cancel' buttons.

- Click **Confirm** to accept the change.

The phone will dial out “*11” automatically when you tap the **CallPull** soft key.

Using SCA Feature on the IP Phone

This section provides you with detailed information on using the SIP VP-T49G IP phone in a SCA Hybrid Key System scenario. In a SCA Hybrid Key System scenario, the status of the line key icon which associates with a shared line will change. For more information on line key icon indicator, refer to [Icon Instructions](#) on page 15.

You can do the following using the IP phone in a SCA Hybrid Key System scenario:

- Placing calls
- Answering calls



- Placing a call on hold
- Retrieving a held call
- Barging in an active call
- Call Pull

Placing Calls

You can have one call or multiple calls on the shared line.



To place a call on the shared line:

Do one of following:

- Enter the desired number using the keypad or the dial pad.
Press , or tap **Send**.
The phone will dial the entered number using the first line key.
- Tap the line key when the phone is idle to enter the dialing screen.
Enter the desired number using the keypad or the dial pad and then press , or tap **Send**.
The phone will dial the entered number using the selected line key.

To place multiple calls on the shared line:

You can have more than one call on the shared line. To place a new call when there is an active call on the line key 1 of phone A, do one of the following on phone A:

- Press  or tap the **Hold** soft key. The original call is placed on hold.
Tap the **NewCall** soft key to enter the dialing screen.
Enter the desired number using the keypad or the dial pad.
Press , or tap **Send**.
Phone A will dial the entered number using the line key 2 automatically.
- Tap the line key. The original call is placed on hold.
Enter the desired number using the keypad or the dial pad.
Press , or tap **Send**.
Phone A will dial the entered number using the selected line key.

Answering Calls





You can have one call or multiple calls on the shared line. Incoming calls will be distributed evenly among the available line keys.

To answer a call on the shared line:

When an incoming call arrives on the shared line, the phone A and phone B will ring simultaneously, and the icon indicators of the line key 1 on both phone A and phone B

will become  and flashing. You can answer the incoming call on either phone A or phone B but not both.

Do one of the following on phone A or phone B:

- Tap the line key 1,  or tap the **Answer** soft key on phone A.
The icon indicators of the line key 1 on phone A and phone B will become  and solid.
- Tap the line key 1,  or tap the **Answer** soft key on phone B.
The icon indicators of the line key 1 on phone A and phone B will become  and solid.

To answer multiple calls on the shared line:

An incoming call arrives on the shared line when there is an active call on phone A's line key 1. The icon indicators of the line key 2 on both phone A and phone B will become  and flashing. You can answer the incoming call on either phone A or phone B. The touch screen of phone A displays the information of the incoming call (e.g., "Incoming call 4604 Yealink").

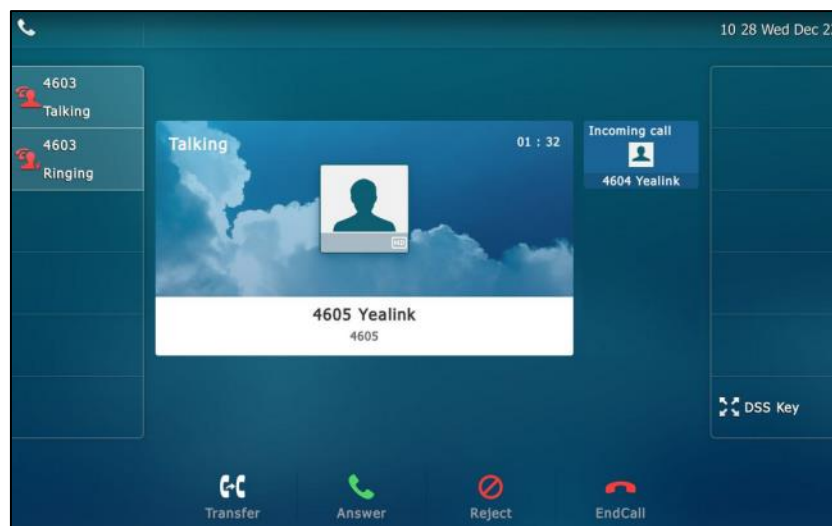

Note Make sure call waiting feature is enabled on phone A. For more information, refer to [Call Waiting](#) on page 205.

Do one of the following on phone A:



- Tap the line key 2. Phone B stops ringing.
- Tap the **Answer** soft key. Phone B stops ringing.
- Tap the incoming call prompt box.
Tap the **Answer** soft key. Phone B stops ringing.

The incoming call is answered and the original call is placed on hold. The icon indicators of the line key 1 on phone A and phone B will become  and solid indicating that

there is the held call on the line key 1. The icon indicators of the line key 2 on phone A and phone B will become  and solid indicating that there is an active call on the line key 2.

You can also answer the call on phone B. Do one of the following on phone B:

- Tap the line key 2. Phone A stops ringing.
- Tap the **Answer** soft key. Phone A stops ringing.

The icon indicators of the line key 2 on phone A and phone B will become  and solid indicating that there is an active call on the line key 2. Meanwhile, the icon indicators of the line key 1 phone A and phone B will become  and solid indicating that there is the held call on the line key 1.

Note

If the number of incoming calls is greater than the configured line keys, the line keys will be used by sequence circulation.

Placing a Call on Hold

To place a call on public hold:

1. Press  or tap the **Hold** soft key on phone A when party A and party C are talking.

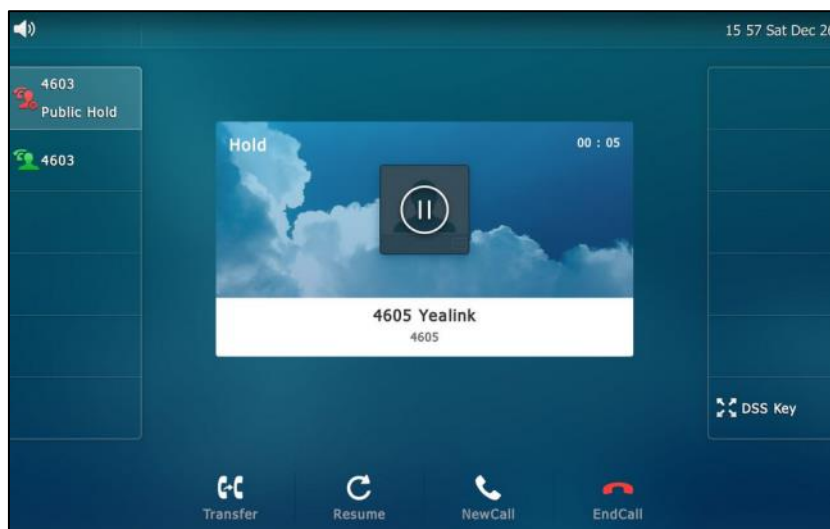



The icon indicators of line key 1 on phone A and phone B will become  .

To place a call on private hold:

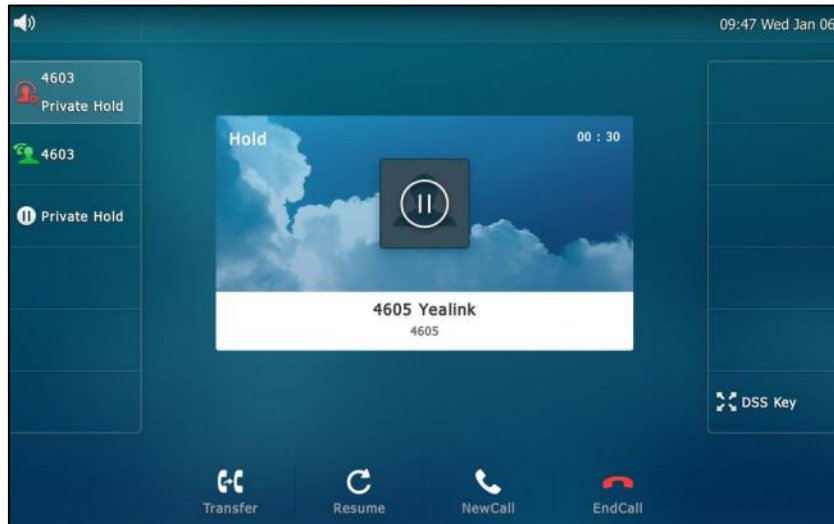
1. Press the **PriHold** soft key or private hold key on phone A when there is an active call on the shared line (You may need to press the **More** soft key to see the **PriHold** soft key).



The icon indicators of line key 1 on phone A will become  when the shared line call is placed on private hold.



The icon indicators of line key 1 on phone B will become  when the shared line call is placed on private hold.

Retrieving a Held Call

To retrieve a call placed on public hold:

You can retrieve the public held call on either phone A or phone B.

To retrieve the call on phone A:

1. Tap , press  or tap the **Resume** soft key.
The conversation between phone A and phone C is retrieved.

To retrieve the call on phone B:

Do one of the following:

- Tap .

- Long tap the desired line key. The **Cancel**, **CallPull**, **NewCall** and **Retrieve** soft keys appear on the touch screen.

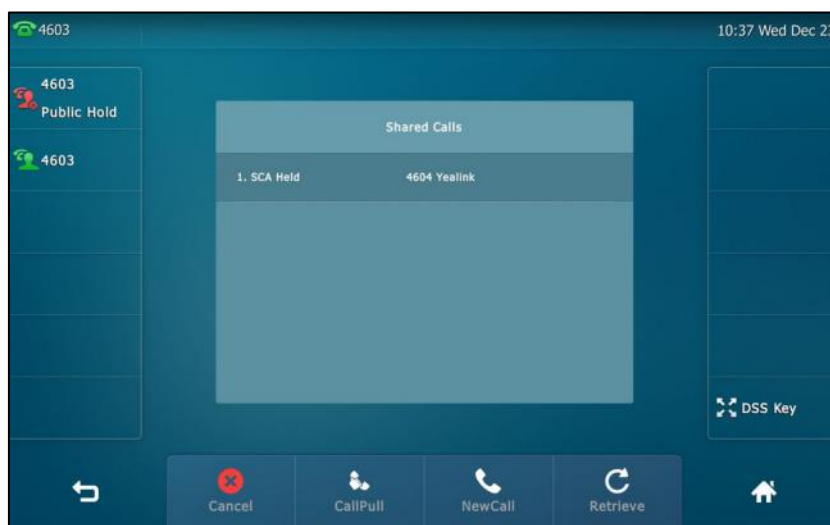



Tap the **Retrieve** soft key to retrieve the call.

The conversation is established between phone B and phone C, phone A disconnects the call. And the line key icon on phone A and phone B will become .

To retrieve a call placed on private hold:

The private held call can be only retrieved by the hold party (party A).

Do the following:

1. Tap , press  or tap the **Resume** soft key on phone A.
The conversation between phone A and phone C is retrieved.

Barging In an Active Call



To interrupt the active call on the shared line:

If phone A has only one active call, do the following:

1. Long tap the desired line key on phone B.

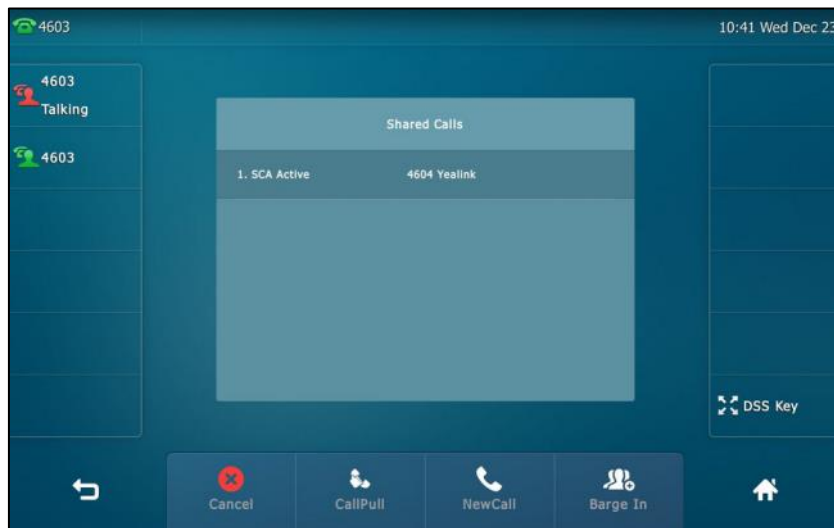
The **Cancel**, **CallPull**, **NewCall** and **Barge In** soft keys appear on the touch screen of phone B.



2. Tap the **Barge In** soft key to interrupt the active call of phone A.
Party B will set up a conference call with the other parties in the active call.
3. Press , tap the **Hold** soft key or the **EndCall** soft key.
 - If any party in the conference call presses  or taps the **Hold** soft key, two-way voice can be heard between the remaining parties.
 - If party A or party B taps the **EndCall** soft key, the remaining parties are still connected. If the other party (not the shared line party) taps the **EndCall** soft key, the conference call is ended.

You can also tap the line key with the solid red icon indicator on phone B to set up a conference call with the other parties in the active call.

If phone A has more than one call, do the following:

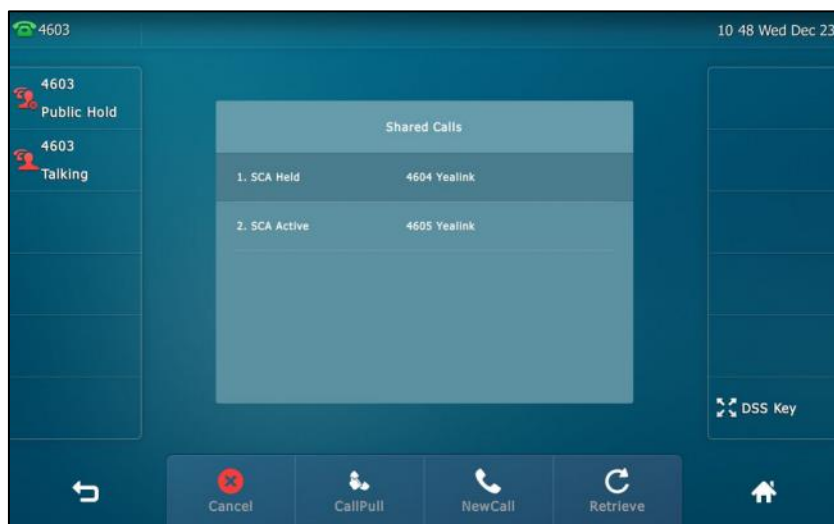

1. Long tap the desired line key on phone B.
The list of calls appears on the touch screen of phone B.

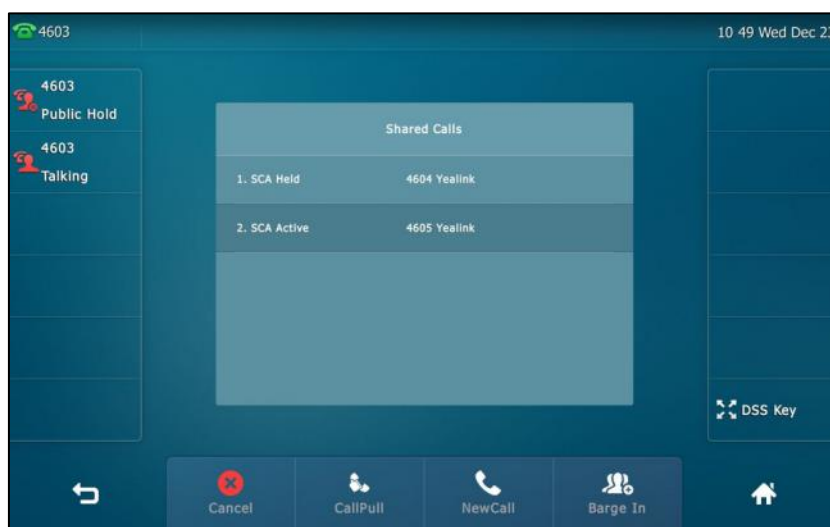

2. Tap the item to select the active call.

The **Cancel**, **CallPull**, **NewCall** and **Barge In** soft keys appear when the active call is highlighted.



3. Tap the **Barge In** soft key to interrupt the active call of phone A.
Party B may hear a warning tone and then set up a conference call with the other parties of the active call.
4. Press , tap the **Hold** soft key or the **EndCall** soft key.
 - If any party in the conference call presses , taps the **Hold** soft key, two-way voice can be heard between the remaining parties.
 - If party A or party B taps the **EndCall** soft key, the remaining parties are still connected. If the other party (not the shared line party) taps the **EndCall** soft key, the conference call is ended.

Call Pull

Call pull feature allows users to retrieve an existing call from another shared phone that is in active or hold status. For example, when there is a call between phone A and phone C, you can use call pull feature on phone B to retrieve this call from phone A. Then the call is established between phone B and phone C.

To retrieve a call from another shared phone:

If there is an active call between phone A and phone C, do the following:

1. Long tap the desired line key on phone B.

The **Cancel**, **CallPull**, **NewCall** and **Barge In** soft keys appear on the touch screen of phone B.

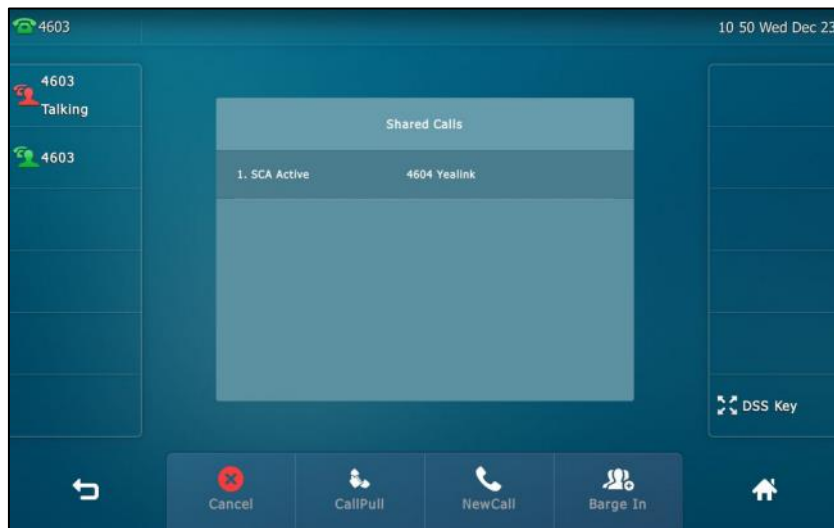

2. Tap the **CallPull** soft key.

The active call has been retrieved from the phone A successfully.

If there is a held call between phone A and phone C, do the following:

1. Long tap the desired line key on phone B.

The **Cancel**, **CallPull**, **NewCall** and **Retrieve** soft keys appear on the touch screen of phone B.

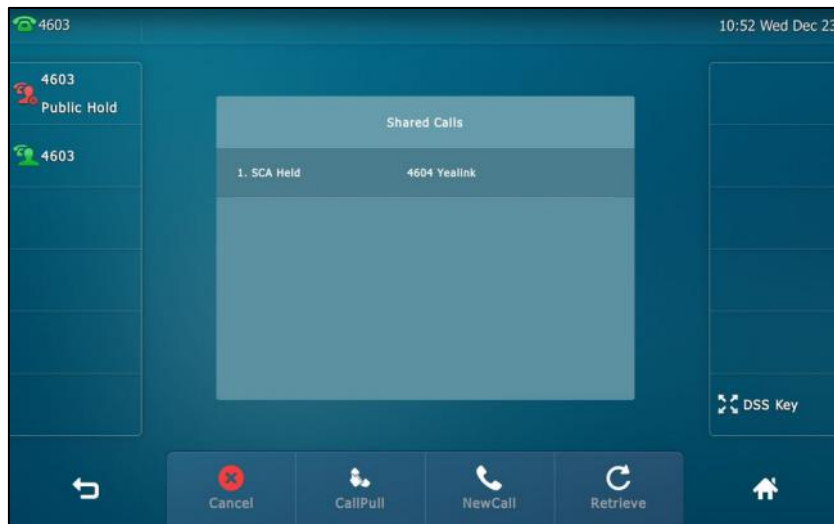

2. Tap the **CallPull** soft key.

The held call has been retrieved from the phone A successfully.

Messages

Short Message Service (SMS)

You can send and receive text messages using the SIP VPT49G IP phone. New text messages can be indicated both acoustically and visually. When receiving a new text message, the phone will play a warning tone. The power indicator LED will slow flash red, and the touch screen will prompt “n New Text Message(s)” (“n” indicates the number of unread text messages. e.g., 1 New Text Message(s)) and display an icon  .

Note

When the phone receives a text message, the text message prompt window will pop up by default, if you want to disable the feature, contact your system administrator for more information.

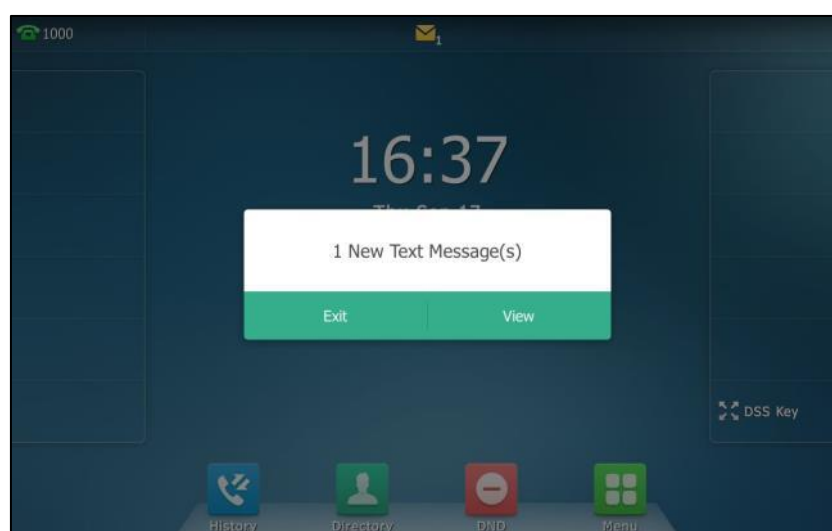

You can store text messages in your phone's Inbox, Sentbox, Outbox or Draftbox. Each of the boxes can store up to 100 text messages. If the number of the text messages in one box is more than 100, the phone will directly delete the oldest text message in the box.

Note

SMS is not available on all servers. Contact your system administrator for more information.

To read a text message:

1. Tap  -> **Message**->**Text Message**->**Inbox**.

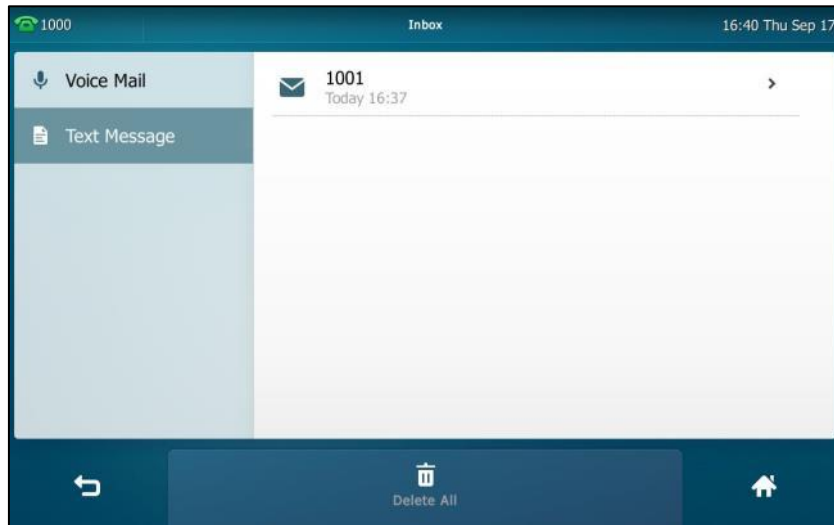

2. Tap the desired text message to read.

Note

If the phone prompts receiving new text messages, you can also tap the **View** soft key to read the new messages directly.

To send a text message:

1. Tap  -> **Message**->**Text Message**->**New Text Message**.
2. Tap the **From** field.
3. Tap the desired account in the pop-up dialog box.

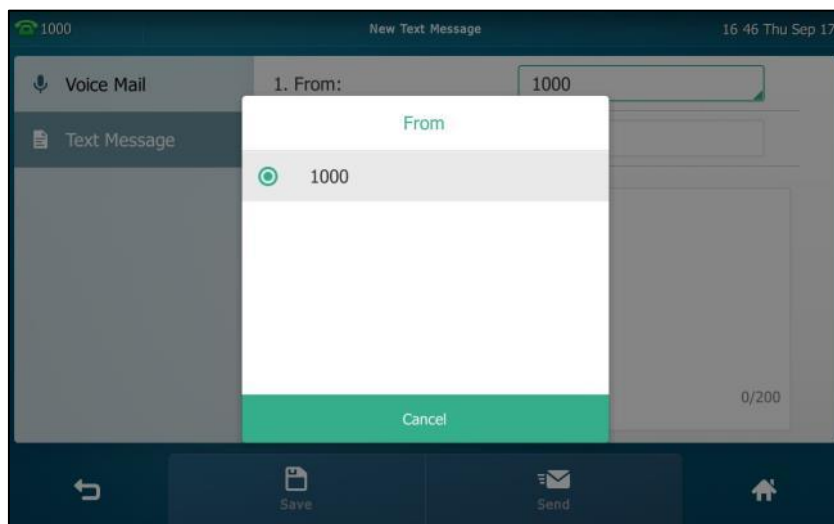

4. Enter the number you want to send the message to in the **To** field.

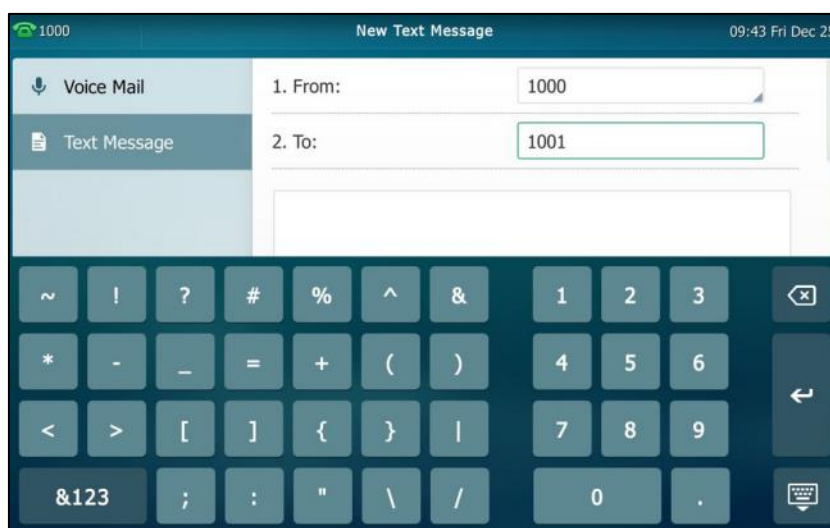

5. Compose the new text message. You can tap **abc** to change the input mode.

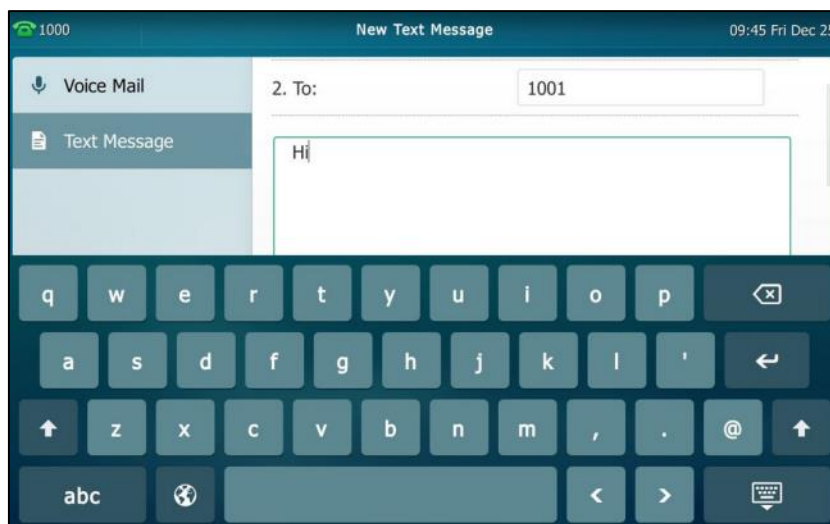

6. Tap **abc** to hide the onscreen keyboard.
7. Tap the **Send** soft key to send or **Cancel** to cancel.

You can also tap the **Save** soft key to save the text message to the draftbox.

Sending a text message is configurable via web user interface at the path **Features->SMS**.

To reply a text message:

1. Tap **Message->Text Message->Inbox**.
2. Select the desired message and tap the **Reply** soft key.

- Compose the new text message. You can tap  to change the input mode.



- Tap  to hide the onscreen keyboard after completing the content.
- Check the **From** and **To** fields, and then tap the **Send** soft key.

To delete a text message:

- Tap  -> **Message**-> **Text Message**-> **Inbox (Sentbox, Outbox or Draftbox)**.
- Tap the desired message and then tap the **Delete** soft key.

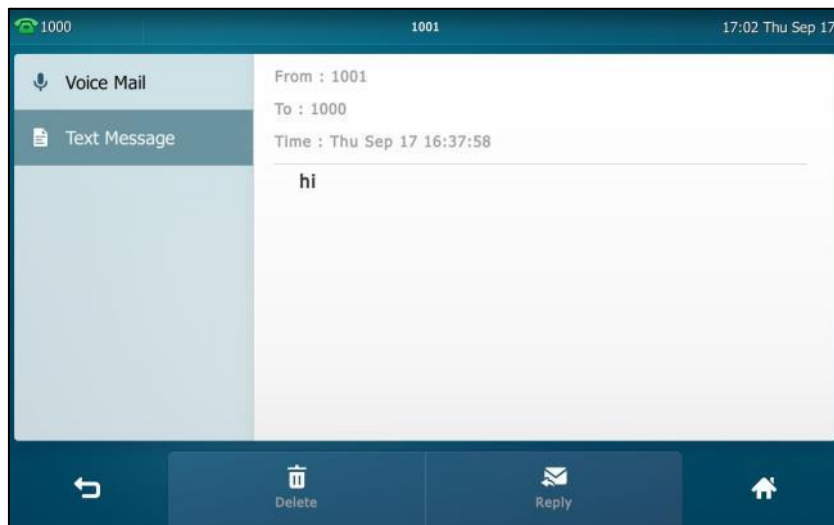

The touch screen prompts “Delete this message?”.

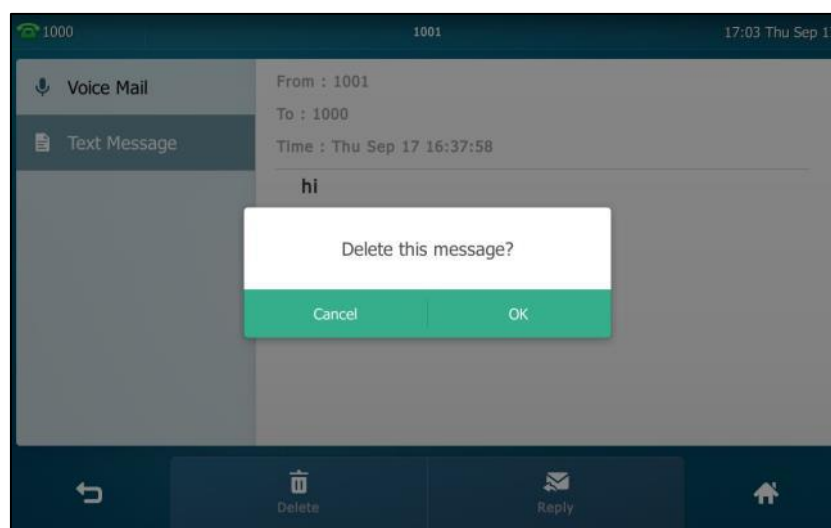

3. Tap **OK** to delete this message or **Cancel** to cancel.

You can also delete all text messages by tapping the **Delete All** soft key. For more information, refer to the above steps.

Note You can also delete a specific message after retrieving by tapping the **Delete** soft key.

Voice Mail/Video Voice Mail

You can leave voice mails/video voice mails for someone else using the SIP VPT49G IP phone. You can also access the voice mails/video voice mails that are stored in the voice mailbox. The usage of video voice mail is the same as that of voice mail, the following takes voice mail as an example.

Note Voice Mail/Video Voice Mail is not available on all servers and differs from different servers. Contact your system administrator for more information.

When receiving a new voice mail, the phone will play a warning tone. The power indicator LED will slow flash red, and the touch screen will prompt “n New Voice Mail(s)” (“n” indicates the number of unread voice mails, e.g., 5 New Voice Mail(s)) and display an icon .

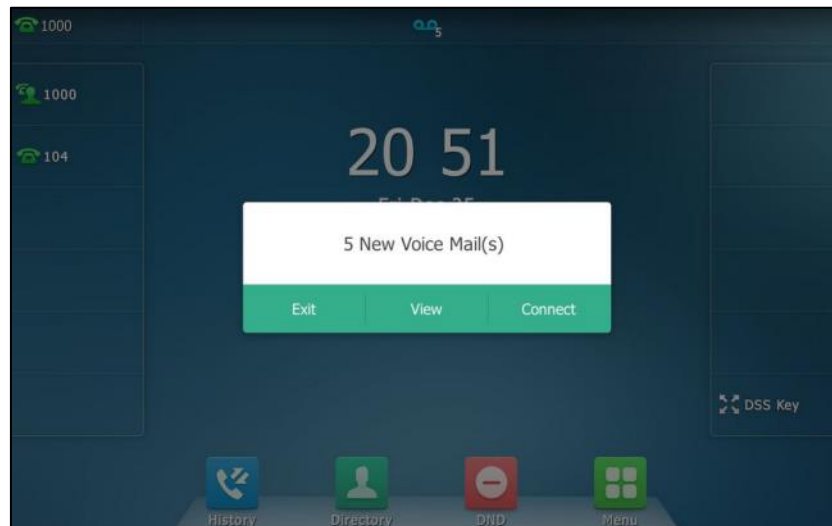

If the voice mail pop-up message box disappears, it won't pop up again unless the user receives a new voice mail or the user re-registers the account that has unread voice mail(s).

Note

You can configure the phone not to display the pop-up prompt, contact your system administrator for more information.

The icon  on the status bar has a counter indicating the number of messages you haven't heard yet.

To leave a voice mail:

You can leave a voice mail for someone else when he/she is busy or inconvenient to answer the call. Follow the voice prompt from the system server to leave a voice mail, and then hang up.

To configure voice mail access codes via phone user interface:

1. Tap  -> **Message**-> **Set Voice Mail**.

2. Enter the voice mail access code (e.g., *88) in the desired account field.

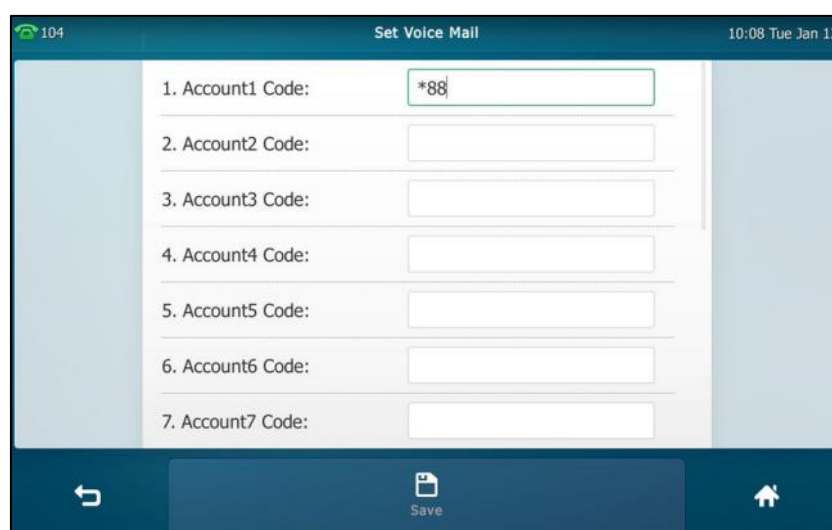

3. Tap the **Save** soft key to accept the change or  to cancel.

Note Voice mail access codes must be predefined on the system server. Contact your system administrator for the more information.

To listen to voice mails:

1. When the touch screen prompts that the phone receives a new voice mail, press  or tap **Connect** to dial out the voice mail access code.
2. Follow the voice prompt to listen to your voice mails.

Note Before listening to voice mails, ensure that the voice mail access code has been configured.

To view the voice mail via phone user interface:

1. Tap  -> **Message**-> **View Voice Mail**.

The touch screen displays the amount of new and old voice mails.

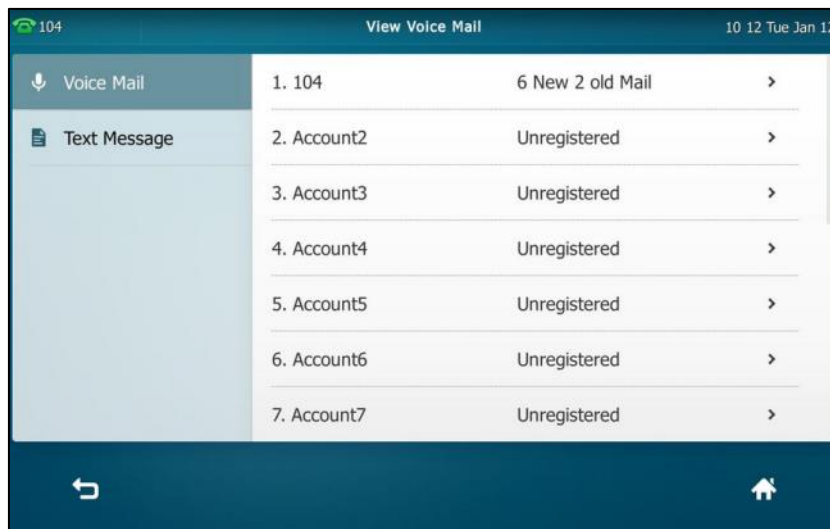

You can tap the account to listen to voice mails.

Message Waiting Indicator (MWI)

The SIP VP-T49G IP phone supports MWI when receiving a new voice mail. If someone leaves you a voice mail, you will receive a message waiting indicator. MWI will be indicated in three ways: a warning tone, an indicator message (including a voice mail icon) on the touch screen, and the power indicator LED slow flashes red. This will be cleared when you retrieve all voice mails or delete them.

The MWI service is unsolicited for some servers, so the SIP VP-T49G IP phone only handles the MWI messages sent from the server. But for other servers, the MWI service is solicited, so the SIP VP-T49G IP phone must enable subscription for MWI.

Note MWI service is not available on all servers. Contact your system administrator for more information.

The MWI subscription parameters you need to know:

Options	Description
Subscribe for MWI	Enable or disable a subscription for MWI service.
MWI Subscription Period	Period of MWI subscription. The IP phone sends a refresh SUBSCRIBE request before initial subscription expires.
Subscribe MWI To Voice Mail	Enable or disable a subscription to the voice mail number for MWI service. To use this feature, you should also configure the voice mail number.

Note

The phone will send SUBSCRIBE messages for MWI service to the account or the voice number MWI service depending on the server. Contact your system administrator for more information.

To configure subscribe for MWI via web user interface

1. Click on **Account->Advanced**.
2. Select the desired account from the pull-down list of **Account**.
3. Select **Enabled** from the pull-down list of **Subscribe for MWI**.
4. Enter the period time in the **MWI Subscription Period(Seconds)** field.

The screenshot shows the Yealink T49G web user interface. The 'Account' tab is selected, and the 'Advanced' sub-tab is active. The 'Subscribe for MWI' field is set to 'Enabled' and the 'MWI Subscription Period(Seconds)' field is set to '3600'. A red box highlights these two fields. The 'Subscribe MWI To Voice Mail' field is set to 'Disabled'. The 'Voice Mail' field is empty. The 'Voice Mail Display' field is set to 'Enabled'. The 'Caller ID Source' field is set to 'FROM'. A 'NOTE' box on the right side of the page states: 'Advanced: The Advanced parameters for administrator. You can click here to get more guides.'

5. Click **Confirm** to accept the change.

The IP phone will subscribe to the account number for MWI service by default.

To enable subscribe MWI to voice mail via web user interface:

1. Click on **Account->Advanced**.

2. Select the desired account from the pull-down list of **Account**.
3. Select **Enabled** from the pull-down list of **Subscribe for MWI**.
4. Select **Enabled** from the pull-down list of **Subscribe MWI To Voice Mail**.
5. Enter the desired voice mail number in the **Voice Mail** field.

The screenshot shows the Yealink T49G web interface. The top navigation bar includes 'Status', 'Account', 'Network', 'DSSKey', 'Features', 'Settings', 'Directory', and 'Security'. The 'Account' tab is active, and the 'Advanced' sub-tab is selected. The settings table is as follows:

Account	Account 1	?
Keep Alive Type	Default	?
Keep Alive Interval(Seconds)	30	?
RPort	Disabled	?
Subscribe Period(Seconds)	1800	?
DTMF Type	RFC2833	?
DTMF Info Type	DTMF-Relay	?
DTMF Payload Type(96~127)	101	?
Retransmission	Disabled	?
Subscribe for MWI	Enabled	?
MWI Subscription Period(Seconds)	3600	?
Subscribe MWI To Voice Mail	Enabled	?
Voice Mail	*98	?
Voice Mail Display	Enabled	?

A 'NOTE' box on the right states: 'Advanced: The Advanced parameters for administrator. You can click here to get more guides.'

6. Click **Confirm** to accept the change.
The IP phone will subscribe to the voice mail number for MWI service using **Subscribe MWI To Voice Mail**.

Note MWI subscription is configurable via web user interface only.

Troubleshooting

This chapter provides general troubleshooting information to help you solve the problems you might encounter when using your SIP VP-T49G IP phone.

If you require additional information or assistance with your new phone, contact your system administrator.

General Issues

How can I find the basic information of the IP phone?

Tap  -> **Status** when the IP phone is idle to check the basic information of the IP phone, such as IP address and firmware version. For more basic information, refer to [Phone Status](#) on page 46.

How to obtain the MAC address of a phone when the phone is not powered on?

Three ways to obtain the MAC address of a phone:

- You can ask your supplier for the shipping information sheet which includes MAC addresses according to the corresponding PO (Purchase Order).
- You can find the MAC address on the label of carton box.
- You can also find the MAC address from the phone's bar code on the back of the phone.

What is the difference between user name, register name and display name?

Both user name and register name are defined by the server. A user name is used to identify the account while a register name matched with a password is used for authentication if required by the server. Display name is the caller ID that will be displayed on the called party's touch screen. Server configuration may override the local configuration.

Display Issues

Why is the touch screen blank?

- Ensure that the phone is properly plugged into a functional AC outlet.
- Ensure that the output of the power adapter is 12V/2A.
- Ensure that the phone is plugged into a socket controlled by a switch that is on.

- If the phone is plugged into a power strip, try to plug it directly into a wall outlet instead.
- Check if the IP phone enters the power-saving mode. For more information, refer to [Power Saving](#) on page 66.

Why does the phone display "Network unavailable"?

- Ensure that the Ethernet cable is plugged into the Internet port on the phone and the Ethernet cable is not loose.
- Ensure that the switch or hub in your network is operational.
- Ensure that the wireless network is available.

Why doesn't the phone display time and date correctly?

Check if you have configured the phone to obtain the time and date from the SNTP server automatically. If the phone fails to connect to the SNTP server, contact your system administrator for more information. You can also configure the time and date manually. For more information, refer to [Time & Date](#) on page 71.

Why does the wallpaper has bad display?

Do one of the following:

- Check that the custom image is clear.
- Check that the file format of the custom image for the wallpaper is *.jpg, *.png or *.bmp.
- Check that the custom image is neither too large nor too small. The phone will adjust the image to be able to display it.
- Check the picture resolution of the wallpaper. The wallpaper resolution of the SIP VPT49G IP phone is 1280*800 pixels.

Password Issues

Why can't I access web user interface using the default administrator user name and password (admin/admin)?

- It is case-sensitive, ensure the case is correct.
- Ensure the password has not been changed.
- If the password has been changed, but the computer remembers the old password, try to clear the browser cache and try again or select another browser to login.

How to change the user password?

To change the user password via web user interface:

1. Click on **Security**->**Password**.
2. Select **user** from the pull-down list of **User Type**.
3. Enter the new user password in the **New Password** field and **Confirm Password** field.

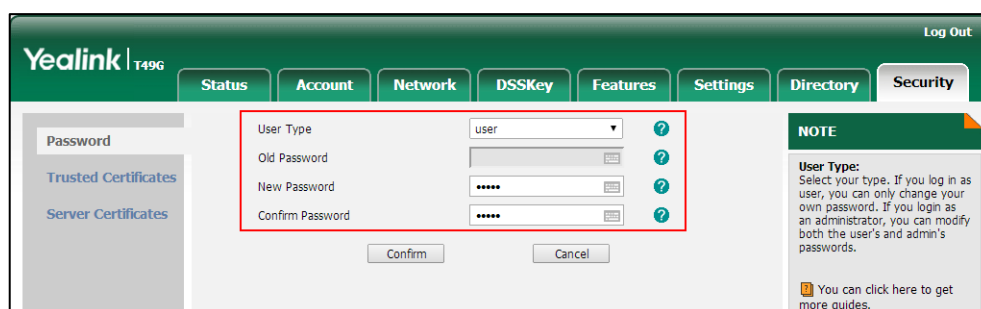

4. Click **Confirm** to accept the change.

You can also contact your system administrator for help.

Note

If you are logging into the web user interface of the phone with user credentials, you need to enter the current user password in the **Old Password** field.

User password is configurable via web user interface only.

Call Issues

Why can't I receive calls?

- Check the SIP registration with your system administrator.
- Check that the DND (Do Not Disturb) mode is deactivated on your phone. Refer to [Do Not Disturb \(DND\)](#) on page 187.
- Check that call forward is disabled on the phone. Refer to [Call Forward](#) on page 192.
- Check whether the caller number is stored in the blacklist directory. Refer to [Blacklist](#) on page 102.

Headset & Handset Issues

Why does my headset not work?

Check that the headset cord is fully connected to both the headset jack on the phone and handset. Refer to [Phone Installation](#) on page 29.

Why does my headset not work?

- Check that the headset cord is properly connected to the headset jack on the phone. Refer to [Phone Installation](#) on page 29.
- Check that the headset mode is activated. Refer to [Headset Use](#) on page 115.
- Check that the headset volume is adjusted to an appropriate level. Refer to [Volume](#) on page 78.

Audio Issues

Why can't I get a dial tone?

- Check for any loose connections and that the phone has been installed properly. For the installation instructions, refer to [Phone Installation](#) on page 29.
- Switch between the Handset, Headset (if present) or Hands-Free Speakerphone to check whether the dial tone is present for one of the audio modes.

If the dial tone exists on another audio mode, connect a different handset or headset to isolate the problem.

Why doesn't the phone ring?

Check the ringer volume on the phone. To adjust the ringer volume setting, press the Volume key when the phone is on-hook and idle. For more information, refer to [Volume](#) on page 78.

Why does the phone play a tone when there is a call on hold? How to disable it?

When there is a call on hold, the phone will play a hold tone every 30 seconds. Call hold tone is enabled by default. Call hold tone and the interval of playing a hold tone are configurable via web user interface only.

To configure call hold tone and call hold tone delay via web user interface:

1. Click on **Features->General Information**.
2. Select the desired value from the pull-down list of **Play Hold Tone**.

3. Enter the desired time in the **Play Hold Tone Delay** field.

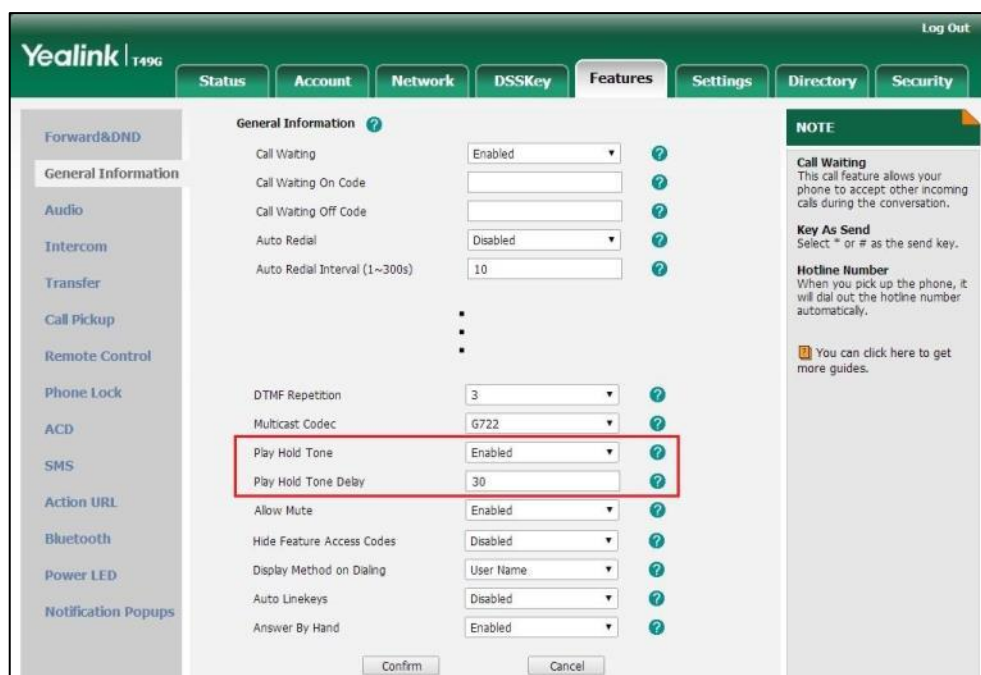

4. Click **Confirm** to accept the change.

How to make a call using SRTP?

You can enable SRTP to encrypt the audio stream(s) of phone calls. The parties participating in the call should enable SRTP on a per-line basis.

To enable SRTP on a per-line basis via web user interface:

1. Click on **Account->Advanced**.
2. Select the desired account from the pull-down list of **Account**.

3. Select the desired value (**Optional** or **Compulsory**) from the pull-down list of **RTP Encryption(SRTP)**.

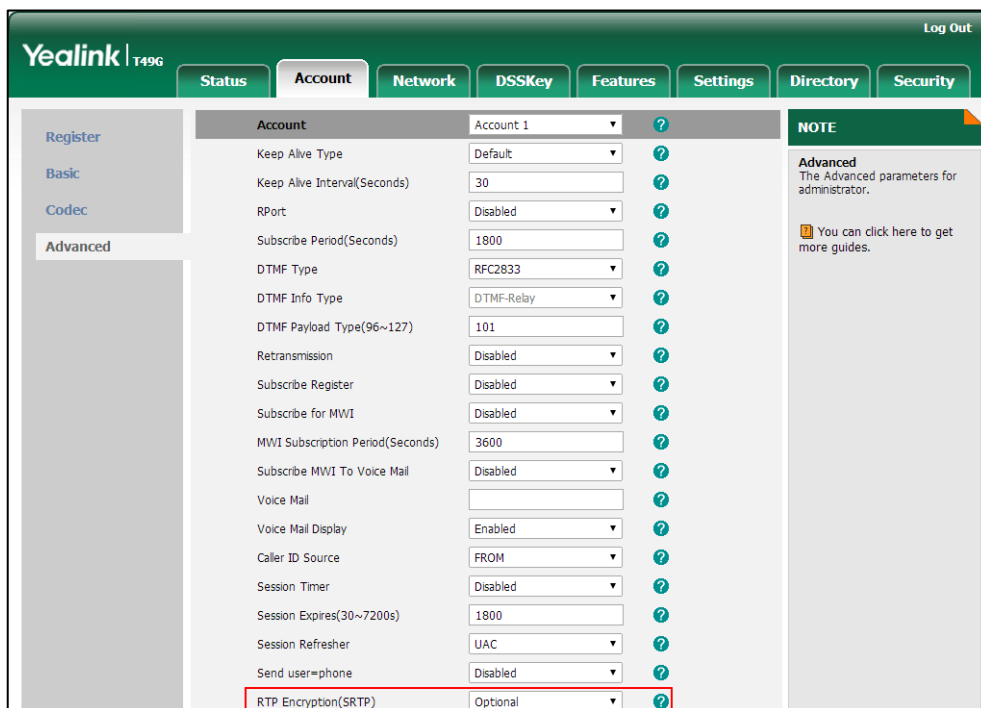

4. Click **Confirm** to accept the change.

Note

SRTP is not available on all servers. Contact your system administrator for more information.

SRTP is configurable via web user interface only.

Video Issues

Why is the video quality bad?

- Check whether the packet has been lost. Click on **Status->Talk Statistics** during a call.

The screenshot shows the Yealink T49G Status page. The 'Status' tab is selected, and the 'Talk Statistics' sub-tab is active. The 'Switch Talk' dropdown is set to 'Susan'. The main content area displays a table of statistics for the current call, categorized into Video and Audio. The 'Video' section is highlighted with a red border. The 'Audio' section is also visible below it. A 'NOTE' box on the right side of the page contains a message: 'You can click here to get more guides.'

Type	Parameter	Recv(1887 kb/s)	Send(2056 kb/s)
Video	Resolution	1920 X 1080	1920 X 1080
	Codec	H264	H264
	Bandwidth	1825 kb/s	1994 kb/s
	Frame Rate	30 fps	30 fps
	Jitter	28 ms	16 ms
	Total Packets Lost	18	0
Packets Lost Rate	0%	0%	
Audio	Codec	G722	G722
	Bandwidth	62 kb/s	62 kb/s
	Sample Rate	15 k	15 k
	Jitter	103 ms	3 ms
	Total Packets Lost	2	0
	Packets Lost Rate	0%	0%

- Check that the parameters of your camera have been set to proper values.
- Check that the network environment is stable. If the network environment is unstable, the status bar will prompt “The network is unstable.”.

What is the available video resolution for the SIP VPT49G IP phone and connected external monitor?

Scenario	Resolution	
	Receive	Send
Single channel video calls	1920 x 1080 (1080P)	1920 x 1080 (1080P)
One to many single channel video calls	1920 x 1080 (1080P)	1920 x 1080 (1080P)
3-way video conference	704 x 576 (4CIF)	1280 x 720 (720P)

Note

The actual resolution depends on the performance of the remote endpoint, and is affected by the quality of the communication channel.

Recording Issues

Why can't I record calls?

- Ensure that the USB flash drive is inserted to the USB port on the phone.
- Ensure that the USB flash drive inserted is compatible with the phone. For more information, contact your reseller.
- Check if there is enough free space (greater than 2 minutes) on the USB flash drive. For more information, refer to on [Storage Space](#) page 238.

Log Issues

How to export PCAP trace?

We may need you to provide a PCAP trace to help analyze your problem.

To export a PCAP trace via web user interface:

1. Click on **Settings->Configuration**.
2. Enter the desired values in the **Packet Capture Count**, **Packet Capture Clip Bytes**, **Pcap Filter Type** and **Packet Filter String** fields.

Packet Capture Count – Configures the count of the number of packets to capture. You can set a value between 1 (least) and 100 (most). The default level is 15.

Packet Capture Clip Bytes – Configures the number of bytes (in KB) of the packet to capture. You can set a value between 100 (least) and 1024 (most). The default level is 1024.

Pcap Filter Type – Configures the filter type of the packet to capture. You can set to Custom, SIP or H245 or H225, RTP. The default value is Custom.

Packet Filter String – Customizes the packet filter string. If it is left blank, the IP phone will not automatically filter any string when capturing packets. It is applicable only if the **Pcap Filter Type** is set to **Custom**.

3. Click **Confirm** to accept the change.
4. Click **Start** to begin capturing signal traffic.
5. Recreate the error to be documented in the trace.
6. Click **Stop** to stop the capture.

7. Click **Export** to open the file download window, and then save the file to your local system.

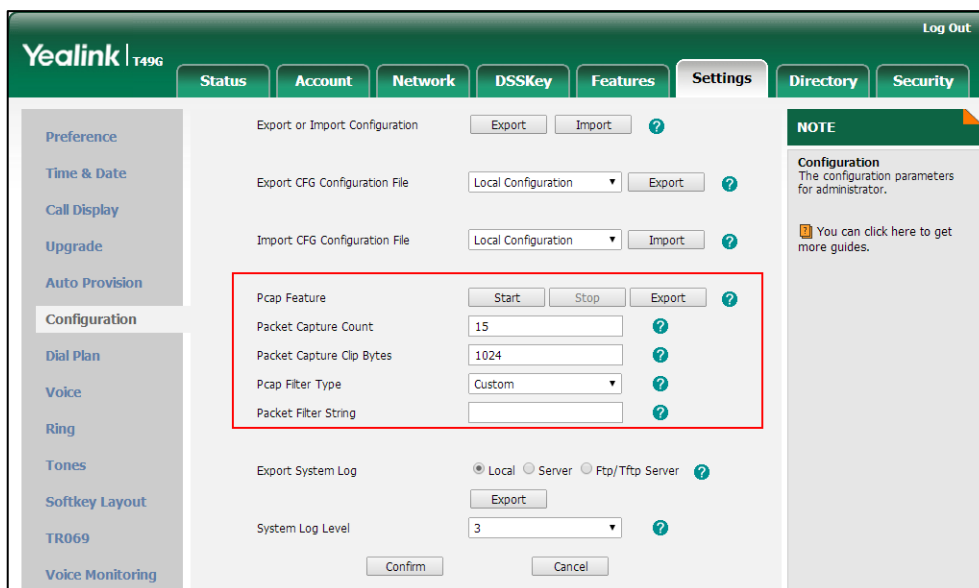

How to export system log?

We may need you to provide a system log to help analyze your problem.

To export the system log to a local PC via web user interface:

1. Click on **Settings->Configuration**.
2. Select **6** from the pull-down list of **System Log Level**.
The default system log level is "3".
3. Click **Confirm** to accept the change.
4. Mark the **Local** radio box in the **Export System Log** field.
5. Reproduce the issue.

- Click **Export** to open the file download window, and then save the file to your local system.

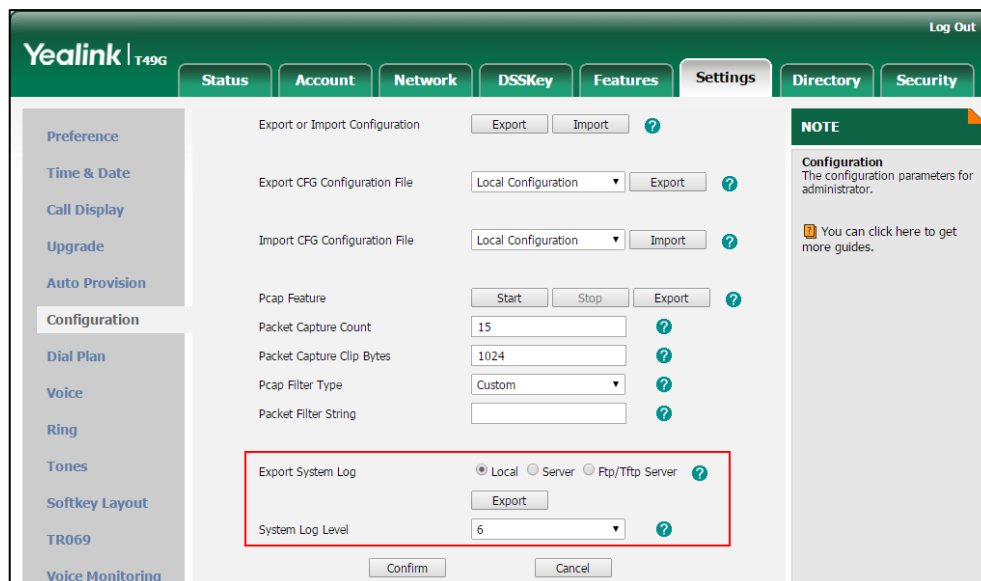

You can also export the system log to a syslog server. Contact your system administrator for more information.

Note

It is recommended to reset the syslog level to 3 after exporting the system syslog.

Reboot & Upgrade & Reset Issues

How to reboot the phone?

To reboot the phone via web user interface:

- Click on **Settings->Upgrade**.
- Click **Reboot** to reboot the IP phone.

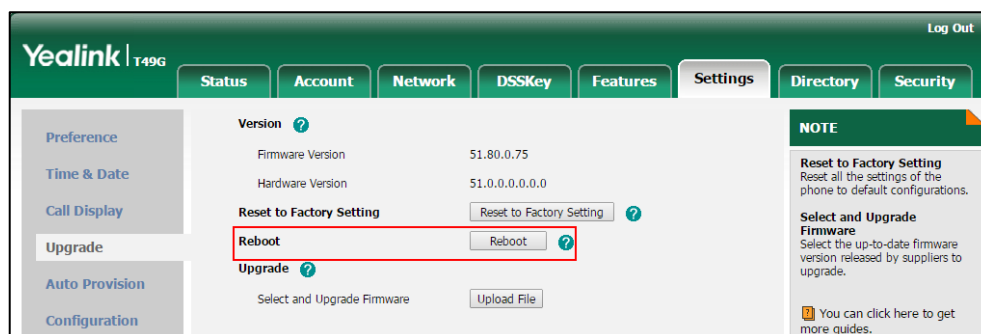

Note

You can also reboot the phone by long pressing ***.*** when the phone is idle. Any reboot of the phone may take a few minutes.

How to upgrade firmware?

To upgrade firmware via web user interface:

1. Click on **Settings->Upgrade**.
2. Click **Upload File** to locate and upload the firmware from your local system.

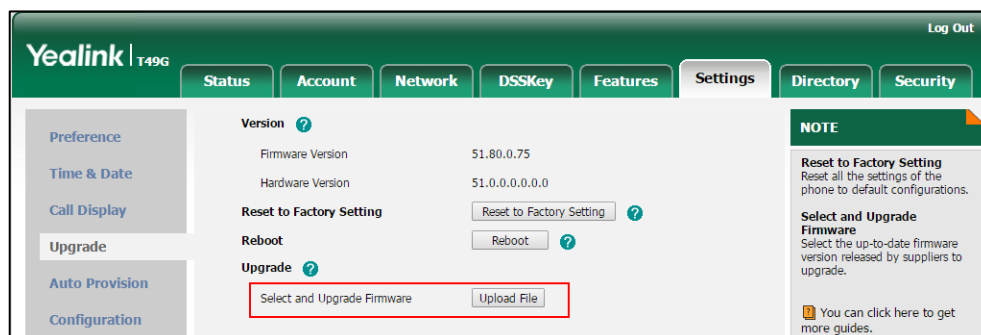

The browser pops up the dialog box “Firmware of the SIP phone will be updated. It will take 5 minutes to complete. Please don't power off!”.

3. Click **OK** to confirm upgrading.

How to reset the phone?

Reset the phone to factory configurations after you have tried all troubleshooting suggestions but do not solve the problem.

Three ways to reset the phone:

- **Full Reset:** All configurations and userdata on the phone will be reset.
- **Config Reset:** All configurations (e.g., account, call history) set on the phone will be reset.
- **Userdata Reset:** All custom data (e.g., ring tone) set on the phone will be reset.

Contact your system administrator before resetting the phone.

To reset the phone via phone user interface:

1. Tap  -> **Advanced** (default password: admin) -> **Reset to Factory**.
2. Tap the **Reset Option** field.
3. Tap the desired reset option in the pop-up dialog box.

4. Tap the **Reset** key.

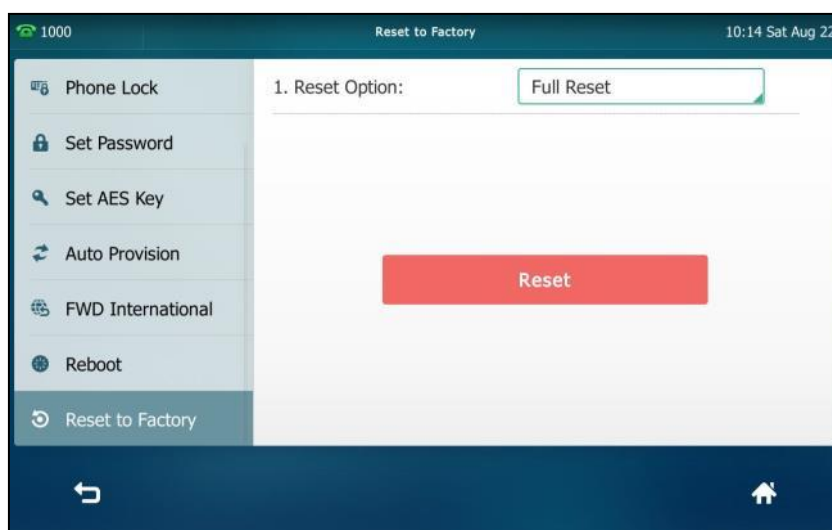

The touch screen prompts the following warning:

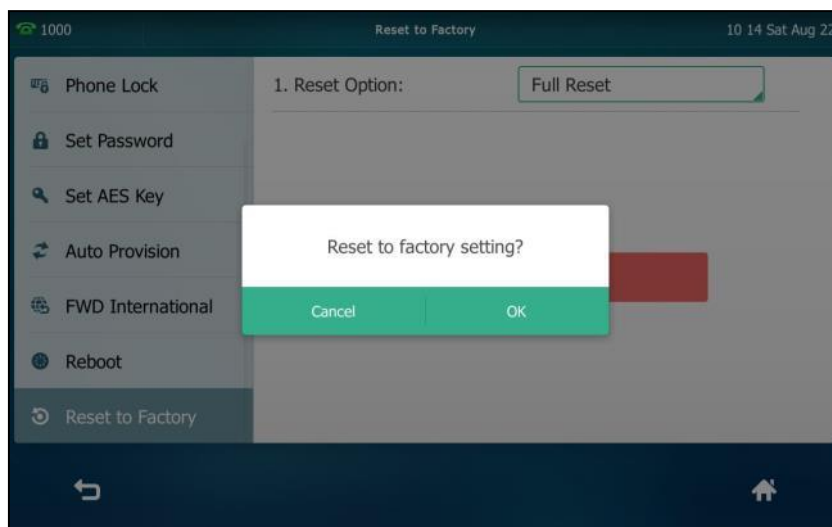

5. Tap **OK**.
The phone begins resetting.

After reset, the touch screen prompts “Welcom Initializing...Please wait”.

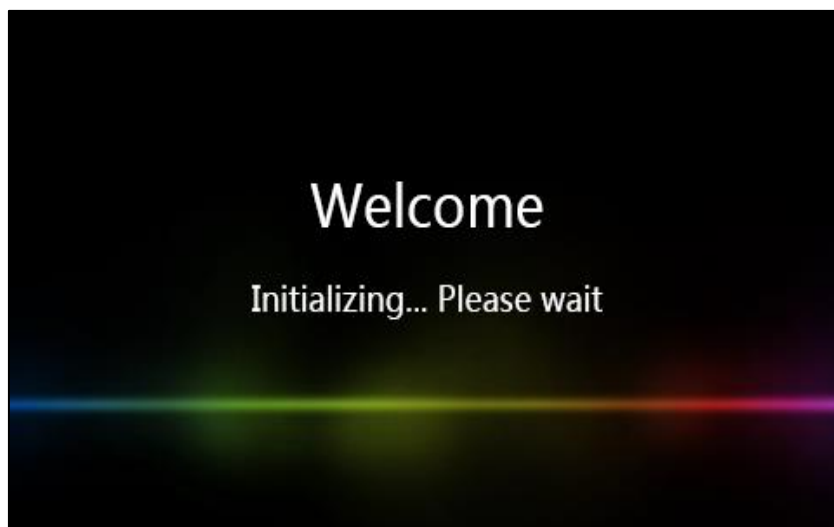

The phone will be reset to factory settings sucessfully after startup.

Note

You can also reset the phone by long pressing  when the phone is idle.

Reset of your phone may take a few minutes. Do not power off until the phone has started up successfully.

Regulatory Notices

Service Agreements

Contact your Yealink Authorized Reseller for information about service agreements applicable to your product.

Limitations of Liability

TO THE FULL EXTENT ALLOWED BY LAW, YEALINK EXCLUDES FOR ITSELF AND ITS SUPPLIERS ANY LIABILITY, WHETHER BASED IN CONTRACT OR TORT (INCLUDING NEGLIGENCE), FOR INCIDENTAL, CONSEQUENTIAL, INDIRECT, SPECIAL, OR PUNITIVE DAMAGES OF ANY KIND, OR FOR LOSS OF REVENUE OR PROFITS, LOSS OF BUSINESS, LOSS OF INFORMATION OR DATA, OR OTHER FINANCIAL LOSS ARISING OUT OF OR IN CONNECTION WITH THE SALE, INSTALLATION, MAINTENANCE, USE, PERFORMANCE, FAILURE, OR INTERRUPTION OF ITS PRODUCTS, EVEN IF YEALINK OR ITS AUTHORIZED RESELLER HAS BEEN ADVISED OF THE POSSIBILITY OF SUCH DAMAGES, AND LIMITS ITS LIABILITY TO REPAIR, REPLACEMENT, OR REFUND OF THE PURCHASE PRICE PAID, AT YEALINK'S OPTION. THIS DISCLAIMER OF LIABILITY FOR DAMAGES WILL NOT BE AFFECTED IF ANY REMEDY PROVIDED HEREIN SHALL FAIL OF ITS ESSENTIAL PURPOSE.

Safety Instructions

Save these instructions. Read these safety instructions before use!

The following basic safety precautions should always be followed to reduce the risk of fire, electrical shock, and other personal injury.

General Requirements

- Before you install and use the device, read the safety instructions carefully and observe the situation during operation.
- During the process of storage, transportation, and operation, please always keep the device dry and clean.
- During the process of storage, transportation, and operation, please avoid collision and crash of the device.
- Please do not attempt to dismantle the device by yourself. In case of any discrepancy, please contact the appointed maintenance center for repair.
- Without prior written consent, no organization or individual is permitted to make any change to the structure or the safety design of the device. Yealink is under no circumstances liable to consequences or legal issues caused by such changes.
- Please refer to the relevant laws and statutes while using the device. Legal rights of others should also be respected as well.

Environmental Requirements

- Place the device at a well-ventilated place. Do not expose the device under direct sunlight.
- Keep the device dry and free of dust.

- Place the device on a stable and level platform.
- Please do not place heavy objects on the device in case of damage and deformation caused by the heavy load.
- Keep at least 10 cm between the device and the closest object for heat dissipation.
- Do not place the device on or near any inflammable or fire-vulnerable object, such as rubber-made materials.
- Keep the device away from any heat source or bare fire, such as a candle or an electric heater.
- Keep the device away from any household appliance with a strong magnetic field or electromagnetic field, such as a microwave oven or a refrigerator.

Operating Requirements

- Do not let a child operate the device without guidance.
- Do not let a child play with the device or any accessory in case of accidental swallowing.
- Please only use the accessories provided or authorized by the manufacturer.
- The power supply of the device must meet the requirements of the input voltage of the device. Please use the provided surge protection power socket only.
- Before plugging or unplugging any cable, make sure that your hands are completely dry.
- Do not spill liquid of any kind on the product or use the equipment near water, for example, near a bathtub, washbowl, kitchen sink, wet basement or near a swimming pool.
- Do not tread on, pull, or over-bend any cable in case of malfunction of the device.
- During a thunderstorm, stop using the device and disconnect it from the power supply. Unplug the power plug and the Asymmetric Digital Subscriber Line (ADSL) twisted pair (the radio frequency cable) to avoid lightning strike.
- If the device is left unused for a rather long time, disconnect it from the power supply and unplug the power plug.
- When there is smoke emitted from the device, or some abnormal noise or smell, disconnect the device from the power supply, and unplug the power plug immediately. Contact the specified maintenance center for repair.
- Do not insert any object into equipment slots that is not part of the product or auxiliary product.
- Before connecting a cable, connect the grounding cable of the device first. Do not disconnect the grounding cable until you have disconnected all other cables.

Cleaning Requirements

- Before cleaning the device, stop using it and disconnect it from the power supply.
- Use a piece of soft, dry and anti-static cloth to clean the device.
- Keep the power plug clean and dry. Using a dirty or wet power plug may lead to electric shock or other perils.

Appendix A - Time Zones

Time Zone	Time Zone Name
-11	Samoa
-10	United States-Hawaii-Aleutian, United States-Alaska-Aleutian
-9:30	French Polynesia
-9	United States-Alaska Time
-8	Canada(Vancouver,Whitehorse), Mexico(Tijuana,Mexicali), United States-Pacific Time
-7	Canada(Edmonton,Calgary), Mexico(Mazatlan,Chihuahua), United States-MST no DST, United States-Mountain Time
-6	Canada-Manitoba(Winnipeg), Chile(Easter Islands), Mexico(Mexico City,Acapulco), United States-Central Time
-5	Bahamas(Nassau), Canada(Montreal,Ottawa,Quebec), Cuba(Havana), United States-Eastern Time
-4:30	Venezuela(Caracas)
-4	Canada(Halifax,Saint John), Chile(Santiago), Paraguay(Asuncion), United Kingdom-Bermuda(Bermuda), United Kingdom(Falkland Islands), Trinidad&Tobago
-3:30	Canada-New Foundland(St.Johns)
-3	Argentina(Buenos Aires), Brazil(DST), Brazil(no DST), Denmark-Greenland(Nuuk)
-2:30	Newfoundland and Labrador
-2	Brazil(no DST)
-1	Portugal(Azores)
0	Denmark-Faroe Islands(Torshavn), GMT, Greenland, Ireland(Dublin), Morocco, Portugal(Lisboa,Porto,Funchal), Spain-Canary Islands(Las Palmas), United Kingdom(London)
+1	Albania(Tirane), Austria(Vienna), Belgium(Brussels), Caicos, Chad, Croatia(Zagreb), Czech Republic(Prague), Denmark(Kopenhagen), France(Paris), Germany(Berlin), Hungary(Budapest), Italy(Rome), Luxembourg(Luxembourg), Macedonia(Skopje), Namibia(Windhoek), Netherlands(Amsterdam), Spain(Madrid)
+2	Estonia(Tallinn), Finland(Helsinki), Gaza Strip(Gaza), Greece(Athens), Israel(Tel Aviv), Jordan(Amman), Latvia(Riga), Lebanon(Beirut), Moldova(Kishinev), Romania(Bucharest), Russia(Kaliningrad), Syria(Damascus), Turkey(Ankara), Ukraine(Kyiv, Odessa)
+3	East Africa Time, Iraq(Baghdad), Russia(Moscow)
+3:30	Iran(Teheran)
+4	Armenia(Yerevan), Azerbaijan(Baku), Georgia(Tbilisi), Kazakhstan(Aktau), Russia(Samara)
+4:30	Afghanistan(Kabul)
+5	Kazakhstan(Aqtobe), Kyrgyzstan(Bishkek), Pakistan(Islamabad), Russia(Chelyabinsk)
+5:30	India(Calcutta)
+5:45	Nepal(Katmandu)
+6	Kazakhstan(Astana, Almaty), Russia(Novosibirsk,Omsk)
+6:30	Myanmar(Naypyitaw)
+7	Russia(Krasnoyarsk), Thailand(Bangkok)
+8	Australia(Perth), China(Beijing), Russia(Irkutsk, Ulan-Ude), Singapore(Singapore)
+8:45	Eucla
+9	Japan(Tokyo), Korea(Seoul), Russia(Yakutsk,Chita)

Time Zone	Time Zone Name
+9:30	Australia(Adelaide), Australia(Darwin)
+10	Australia(Brisbane), Australia(Hobart), Australia(Sydney,Melbourne,Canberra), Russia(Vladivostok)
+10:30	Australia(Lord Howe Islands)
+11	New Caledonia(Noumea), Russia(Srednekolymsk Time)
+11:30	Norfolk Island
+12	New Zealand(Wellington,Auckland), Russia(Kamchatka Time)
+12:45	New Zealand(Chatham Islands)
+13	Tonga(Nukualofa)
+13:30	Chatham Islands
+14	Kiribati

Index

A

About This Guide [v](#)
 Accessing the Remote Phone Book [105](#)
 Account Management [141](#)
 Activating the Bluetooth Mode [117](#)
 Adding Contacts [86](#)
 Adding Groups [83](#)
 Administrator Password [73](#)
 Advanced Phone Features [223](#)
 Anonymous Call [215](#)
 Anonymous Call Rejection [216](#)
 Answering Calls [158](#)
 Appendix A - Time Zones [301](#)
 Attended Transfer [204](#)
 Area Code [149](#)
 Audio Issues [288](#)
 Audio Settings [78](#)
 Auto Answer [179](#)
 Automatic Call Distribution (ACD) [255](#)
 Auto Redial [180](#)

B

Backlight [66](#)
 Barging In an Active Call [270](#)
 Basic Network Settings [47](#)
 Basic Phone Features [155](#)
 Blacklist [102](#)
 Blind Transfer [202](#)
 Block Out [150](#)
 Bluetooth Headset [117](#)
 Bluetooth-Enabled Mobile Phone [123](#)
 Busy Lamp Field (BLF) [223](#)
 BLF List [230](#)

C

Call and Conference Recording Using a USB Flash Drive [232](#)
 Call Completion [182](#)
 Call Forward [192](#)
 Call Mute [184](#)
 Call History Management [109](#)
 Call Hold/Resume [185](#)
 Call Issues [287](#)
 Call Park [210](#)
 Call Pickup [211](#)
 Capturing Screenshots during a Video Call [218](#)
 Call Recording Using a Record Key [238](#)
 Call Record [233](#)
 Call Issues [287](#)
 Call Transfer [202](#)
 Call Waiting [205](#)
 Changing Video Call Settings [161](#)

Changing the Video Settings [168](#)
 Changing the Clarity of Near-Site Video [162](#)
 Changing the Video Layout during Calls [169](#)
 Changing the Wallpaper via Phone User Interface [61](#)
 Conference [206](#)
 Conference Recording [235](#)
 Configuring an Access URL [104](#)
 Configuring the BLF Feature on the Phone [223](#)
 Configuring SCA Feature on the IP Phone [258](#)
 Configuring the Screen Saver via Web User Interface [65](#)
 Configuration Screen Display [34](#)
 Connecting to the Wired Network [33](#)
 Connecting to the Wireless Network [33](#)
 Contact Management [82](#)
 Control Center/Notification Center [40](#)
 Copyright [ii](#)
 Customizing Your Phone [61](#)

D

Deactivating the Bluetooth Mode [123](#)
 Declaration of Conformity [ii](#)
 Default Account [141](#)
 Deleting Contacts [91](#)
 Deleting Groups [85](#)
 Deleting History Records [111](#)
 Deleting the Paired Bluetooth Headset [121](#)
 Disabling Wi-Fi Feature [59](#)
 Dial-now [148](#)
 Dial Plan [146](#)
 Disabling History Records [114](#)
 Disconnecting the Bluetooth Headset [121](#)
 Disconnecting the Wireless Network Connection [56](#)
 Display Issues [285](#)
 Do Not Disturb (DND) [187](#)
 Documentations [24](#)
 DSS Keys [130](#)
 Dual Headset [116](#)
 Dynamic Forwarding [192](#)

E

Editing Contacts [90](#)
 Editing Groups [84](#)
 Emergency Number [151](#)
 Ending Calls [161](#)
 Entering Data and Editing Fields [41](#)
 External Monitor [175](#)

G

- General Issues [285](#)
- General Settings [61](#)
- Gestures [39](#)
- Getting Started [27](#)

H

- Hardware Component Instructions [13](#)
- Headset & Handset Issues [287](#)
- Headset Use [115](#)
- Headset Mode Activation/Deactivation [115](#)
- Headset Prior [115](#)
- Hotline [153](#)
- Hot Desking [241](#)

I

- Icon Instructions [15](#)
- Idle Screen Display [34](#)
- Importing/Exporting Contact lists [99](#)
- In This Guide [v](#)
- Incoming/Outgoing Call Lookup [106](#)
- Incoming Intercom Calls [244](#)
- Intercom [243](#)

K

- Key as Send [74](#)

L

- Language [69](#)
- LED Instructions [21](#)
- Limitation of Liability [299](#)
- Line Keys [130](#)
- Live Dialpad [152](#)
- Local Conference [206](#)
- Local Directory [82](#)
- Log Issues [292](#)

M

- Making a Mobile Phone Call by using the IP Phone [128](#)
- Managing the Saved Wireless Network [58](#)
- Manually Add a Wireless Network [55](#)
- Manually Connect an Available Wireless Network [50](#)
- Message Waiting Indicator (MWI) [281](#)
- Messages [274](#)
- Mobile Contacts [106](#)
- Multicast Paging [247](#)
- Multiple Line Keys per Account [145](#)
- Music on Hold [254](#)

N

- Navigating Menus and Fields [39](#)
- Network Conference [209](#)

- Network Connection [32](#)

P

- Packaging Contents [27](#)
- Pairing and Connection the Bluetooth-Enabled Mobile Phone [123](#)
- Pairing and Connecting the Bluetooth Headset [118](#)
- Password Issues [286](#)
- Phone Initialization [33](#)
- Phone Installation [29](#)
- Phone Lock [75](#)
- Phone Status [46](#)
- Phone User Interface [22](#)
- Power Saving [66](#)
- Previewing the Near-Site Video [174](#)
- Programable Key [140](#)
- Placing Calls [156](#)
- Placing Calls to Contacts [95](#)

O

- Outgoing Intercom Calls [244](#)
- Overview [13](#)
- Optional Accessories [29](#)

R

- Reboot & Upgrade & Reset Issues [294](#)
- Recent Call In Dialing [178](#)
- Receiving Mobile Phone Calls by using the IP Phone [130](#)
- Receiving RTP Stream [251](#)
- Recall [184](#)
- Recorded Calls Playback [235](#)
- Recording Issues [292](#)
- Redialing Numbers [175](#)
- Registration [34](#)
- Regulatory Notices [299](#)
- Remote Phone Book [104](#)
- Replace Rule [146](#)
- Ring Tones [80](#)

S

- Safety Instructions [299](#)
- Screen Saver [64](#)
- Search Source List in Dialing [97](#)
- Searching for Contacts [96](#)
- Semi-Attended Transfer [203](#)
- Sending RTP Stream [247](#)
- Service Agreements [299](#)
- Setting Wallpaper by Using USB Flash Drive [63](#)
- Short Message Service (SMS) [274](#)
- Share Call Appearance (SCA) [257](#)
- Static Forwarding [192](#)
- Stopping Transmitting Video during a Call [161](#)
- Storage Space [238](#)
- Summary of Changes [v](#)

Syncing the Mobile Contacts to the IP
Phone 127
System Customizations 115

T

Table of Contents vii
Touch Screen Display 34
Time & Date 71
Troubleshooting 285

U

Uploading Contact Photos 93
Uploading the Custom Wallpaper via
Web User Interface 62
Uploading the Custom Picture via Web
User Interface 64
User Interfaces 22
Using BLF Feature on the Phone 228
Using SCA Feature on the IP Phone
265
Using the Onscreen Keyboard 41
Using the Phone Keypad and Dial Pad
44
Using Intercom 246
Using Multicast Paging 252

V

Viewing History Records 109
Viewing the Pictures Stored in Your USB
Flash Drive 221
Viewing the Wireless Network
Information 57
Video Call Screen Display 37
Video Call Full-Screen Display (Both Far-
and Near- Site Videos Exits) 38
Video Issues 291
Voice Mail/Video Voice Mail 278
Volume 78

W

Warranty ii
Wallpaper 61
Web User Interface 22
WEEE Warning iii
Wi-Fi Protected Setup (WPS) 53
Wireless Network Settings 50