

# Yealink

## HD IP Conference Phone CP860

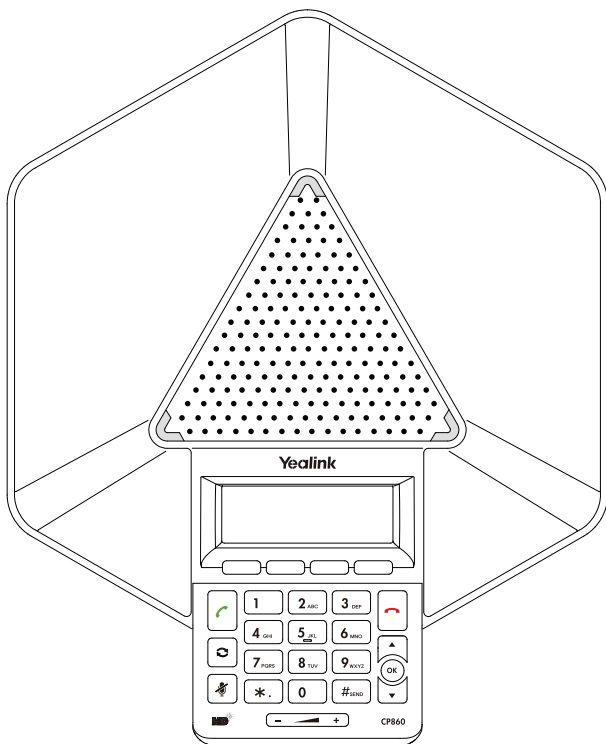

### Quick Start Guide (V81.10)

# Packaging Contents

The following items are included in your package. If you find anything missing, contact your system administrator.

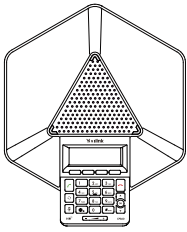

IP Conference Phone



Ethernet Cable

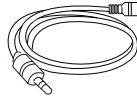

Mobile Device Cable  
(3.5mm Jack)

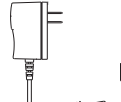

Power Adapter

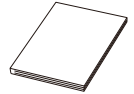

Quick Start Guide



PSTN Box CPN10



3m PSTN Cable



Double-side Tape



Quick Start Guide

CPN10 (Optional)

Note: The PSTN box CPN10 is used to connect CP860 conference phones to the PSTN (Public Switched Telephone Network). The PSTN box CPN10 should be purchased separately. For more information, refer to Yealink PSTN Box CPN10 Quick Start Guide.

# Assembling the Phone

## 1. Connect the network and power, as shown below:

You have two options for network and power connections. Your system administrator will advise you which one to use.

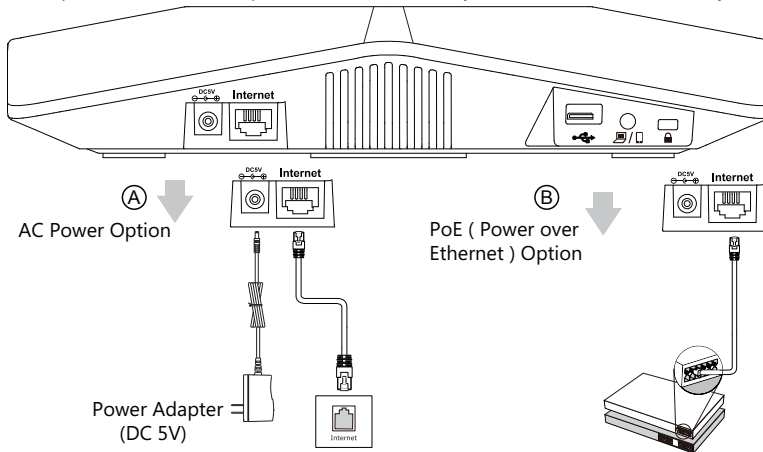

Note: The IP phone should be used with Yealink original power adapter (5V/2A) only. If inline power (PoE) is provided, you don't need to connect the power adapter. Make sure the hub/switch is PoE-compliant.

## 2. Connect the optional USB flash drive, as shown below:

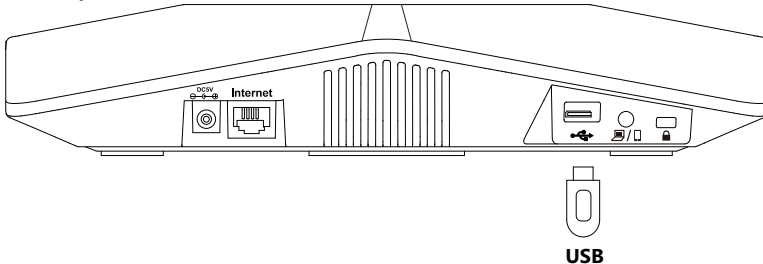

Note: The USB port can also be used to connect the expansion PSTN box CPN10.

**3. Connect the optional expansion microphone, as shown below:**

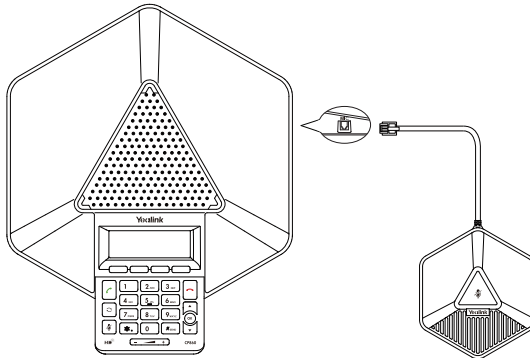

Note: Up to two expansion microphones can be connected to an IP conference phone.

**4. Connect the optional PC or mobile device, as shown below:**

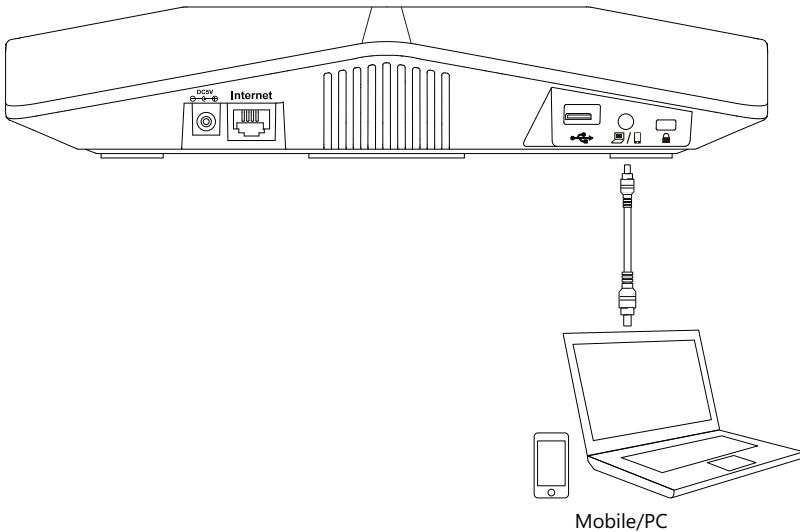

## Startup

After the IP phone is connected to the network and supplied with power, it automatically begins the initialization process. When the IP phone is first powered on, it goes to the setup wizard screen after startup. The setup wizard guides you to configure some basic features via phone user interface. After you complete the setup wizard, the phone is ready for use. You can configure the phone via phone user interface or web user interface.

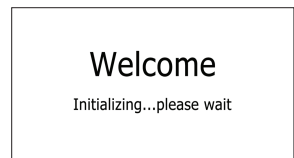

# Hardware Component Instructions

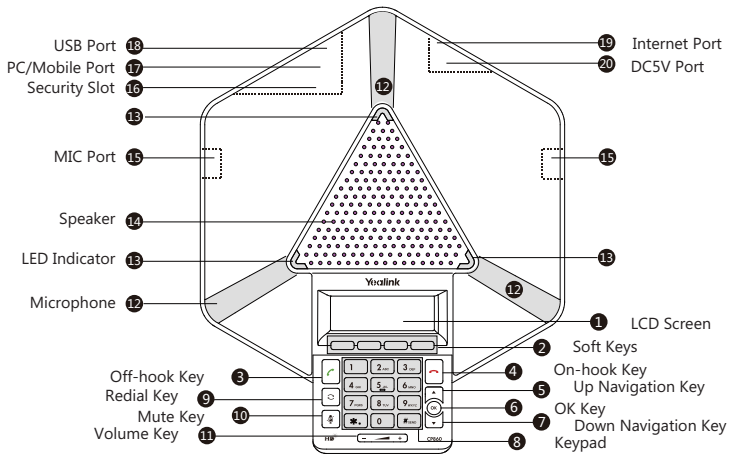

## Configuring Your Phone

### Configuring via web user interface

#### Accessing the web user interface:

1. Press the **OK** key when the phone is idle to obtain the IP address of the phone.
2. Open the web browser on your computer, enter the IP address into the address bar (e.g., "http://192.168.0.10" or "192.168.0.10") and press **Enter**.
3. Enter the user name (default: admin) and password (default: admin) in the login page and click **Confirm**.

#### Account Settings: Click on **Account**->**Register**

#### Parameters of the SIP/Yealink Cloud account:

Register Status:	It shows the register status of the current account.
Line Active:	You can select Enabled/Disabled to enable/disable the account.
Label:	It is shown on the LCD screen to identify the account.
Display Name:	It is shown as Caller ID when placing a call.
Register Name:	It is an authenticated ID for authentication provided by ITSP (required).
User Name:	It is provided by ITSP for registration (required).
Password:	It is provided by ITSP for registration (required).
Server Host:	It is provided by ITSP for registration (required).

#### Parameters of the PSTN account:

Register Status:	It shows the register status of the current account.
Line Active:	You can select Enabled/Disabled to enable/disable the account.
Label:	It is shown on the LCD screen to identify the account.

#### Register status icons on the LCD screen:



Registered (SIP/PSTN account)



Register Failed (SIP account)



Registered (Yealink Cloud account)



Registering (SIP account)

Note: Check with your system administrator if any error appears during the registration process or if a specific configuration is required for your registration.

### Configuring via phone user interface

#### Account Settings:



Press the **Menu** soft key when the phone is idle, select **Settings->Advanced Settings** (default password: admin) ->**Accounts** to configure the account.

Note: For more information on account parameters, refer to **Configuring via web user interface** above.



## Basic Call Features

### Placing a Call

#### Do one of the following:

- Press  .  
Enter the number, and then press , ,  or the **Send** soft key.
- Enter the number.  
Press , ,  or the **Send** soft key.

### Answering a Call





Press ,  or the **Answer** soft key.

Note: You can reject an incoming call by pressing the **Reject** soft key or on-hook key.



### Ending a Call

Press  or the **EndCall** soft key.

### Redial

- Press  to enter the **Placed Calls** list, press  or  to select the desired entry, and then press  or the **Send** soft key.
- Press  twice when the phone is idle to dial out the last dialed number.

### Call Mute and Un-mute



- Press  to mute the microphone during a call.
- Press  again to un-mute the call.

### Call Hold and Resume

#### To place a call on hold:

Press the **Hold** soft key during an active call.

#### To resume the call, do one of the following:

- If there is only one call on hold, press the **Resume** soft key.
- If there is more than one call on hold, press  or  to select the desired held call, and then press the **Resume** soft key.



### Local Conference

CP860 can host up to five-way conference call with other parties.

#### To create a three-way local conference:





1. Press the **Conf** soft key during an active call. The call is placed on hold.
2. Enter the number of the second party, and then press the **Send** soft key.
3. Press the **Conf** soft key again when the second party answers.

#### To join more parties in an established conference call:

1. Press the **Conf** soft key after the conference call is established.
2. Enter the number of the new party, and then press , ,  or the **Send** soft key.
3. Press the **Conf** soft key when the party answers.

4. Repeat steps 1 to 3 to join more parties in the established conference call.

**During the conference call, you can do the following:**

- Press the **Hold** soft key to place the conference on hold.
- Press the **Conf** soft key to join more parties in an established conference call.
- Press the **Manage** soft key, and then press  or  to select the desired party:
  - Press the **FarMute** soft key to forbid the selected party from speaking. The muted party can hear everyone, but no one can hear the muted party.
  - Press the **Remove** soft key to remove the selected party from the conference call.
  - Press the **All Split** soft key to split the conference call into individual calls on hold.
  - Press the **Back** soft key to return to the previous screen.
- Press  to mute the conference call.
- Press  or the **EndCall** soft key to drop the conference call.

Note: To set up a conference for one PSTN account, you need to activate a hook flash. For more specific information, refer to Yealink CP860 User Guide.

**Call Recording**

You can insert a USB flash drive into the USB port on your phone to record active calls and conferences. But this feature is not available by default. When connecting the PSTN box CPN10, you need to connect the USB flash drive to the USB port on the PSTN box CPN10 in advance.

Note: It is necessary to know about the rules and restrictions of any governing call-recording in the place where you are.

It is also very important to have the consent of the person you are calling before recording the conversation. The recorded files will be stored on your USB flash drive.

**To record a call:**

1. Press the **More** soft key, and then press the **Start REC** soft key during a call.



**To stop recording:**

1. Press the **More** soft key, and then press the **Stop REC** soft key.



**Recorded Calls Playback**

You can play back recorded calls on your phone through the phone's speaker.

**To browse the recorded files:**

1. Press **Menu->USB Record->Browse Audio**.
2. Press  or  to scroll through the recorded files.

**To play back a recording:**



1. Press **Menu->USB Record->Browse Audio**.
2. Press  or  to highlight the recording you want to play back.
3. Press the **Play** soft key.

**During the recording playback, you can do the following:**

- To pause the playback, press the **Pause** soft key.  
You can press the **Play** soft key to continue the playback.
- To skip forward the playback, press **▶▶**. Press once to skip forward 8 seconds.
- To rewind the playback, press **◀◀**. Press once to rewind 8 seconds.
- To stop the playback, press the **Back** soft key.

# Customizing Your Phone

## Call History

1. Press the **History** soft key when the phone is idle.
2. Select the desired call history list and press the **Enter** soft key.
3. Press  or  to select an entry from the list, you can do the following:
  - Press the **Send** soft key to call the entry.
  - Press the **Delete** soft key to delete the entry from the list.

If you press the **Option** soft key, you can also do the following:



- Select **Detail** to view detailed information about the entry.
- Select **Add to Contact** to add the entry to the local directory.
- Select **Add to Blacklist** to add the entry to the blacklist.
- Select **Delete All** to delete all entries from the list.

## Contact Directory



### To add a contact:

1. Press the **Directory** soft key when the phone is idle, and then select **All Contacts**.
2. Press the **Add** soft key to add a contact.
3. Enter a unique contact name in the **Name** field and contact numbers in the corresponding fields.
4. Select the desired ring tone from the **Ring** field.
5. Press the **Add** soft key to accept the change.

### To edit a contact:



1. Press the **Directory** soft key when the phone is idle, and then select **All Contacts**.
2. Press  or  to select the desired contact, press the **Option** soft key and then select **Detail**.
3. Edit the contact information.
4. Press the **Save** soft key to accept the change.

### To delete a contact:





1. Press the **Directory** soft key when the phone is idle, and then select **All Contacts**.
2. Press  or  to select the desired contact, press the **Option** soft key and then select **Delete**.
3. Press the **OK** soft key when the LCD screen prompts "Delete selected item?".

Note: You can add contacts from call history easily. For more information, refer to **Call History** above.

## Volume Adjustment

- Press  during a call to adjust the receiver volume of the speaker.
- Press  when the phone is idle or ringing to adjust the ringer volume.
- Press  to adjust the media volume in the corresponding screen.

## Ring Tones

1. Press the **Menu** soft key when the phone is idle, and then select **Settings->Basic Settings->Sound->Ring Tones->Common**.
2. Press  or  to select **Common** or the desired account and then press the **Enter** soft key.
3. Press  or  to select the desired ring tone.
4. Press the **Save** soft key to accept the change.

## About us

Founded in 2001, Yealink, a leading provider of VoIP Phone and IP communication solutions, has been focusing on VoIP products characterized by reliable quality, easy deployment and affordable price for more than a decade. Today, customers from over 140 countries rely on Yealink as the backbone of global collaboration to extend the value of network communications.

## More about Yealink

Since 2001, Yealink has continued to develop state-of-the art, hi-tech VoIP communication terminals that include IP video phones, IP phones and USB phones. With a worldwide market in more than 140 countries, the company has also established a first-class international service network.

Our priorities are quality, functionality, ease-of-use, customer support and competitive pricing. To provide new solutions for the future in this fast-evolving sector, Yealink's large, talented and highly-experienced VoIP R&D team is totally committed to the pursuit of excellence.

To date, we have passed more than 80 interoperability tests and meet certification requirements set by leading VoIP system and platforms. Yealink works in close partnership with T-Mobile, Telefonica, Portugal Telecom and other leading telecommunication service providers.



YEALINK(XIAMEN) NETWORK TECHNOLOGY CO.,LTD.  
Web: [www.yealink.com](http://www.yealink.com)  
Addr: 309, 3th Floor, No.16, Yun Ding North Road, Huli  
District, Xiamen City, Fujian, P.R. China  
Copyright©2017YEALINK(XIAMEN) NETWORK  
TECHNOLOGY CO.,LTD.All rights reserved.