

# Yealink

## HD IP Conference Phone

CP960

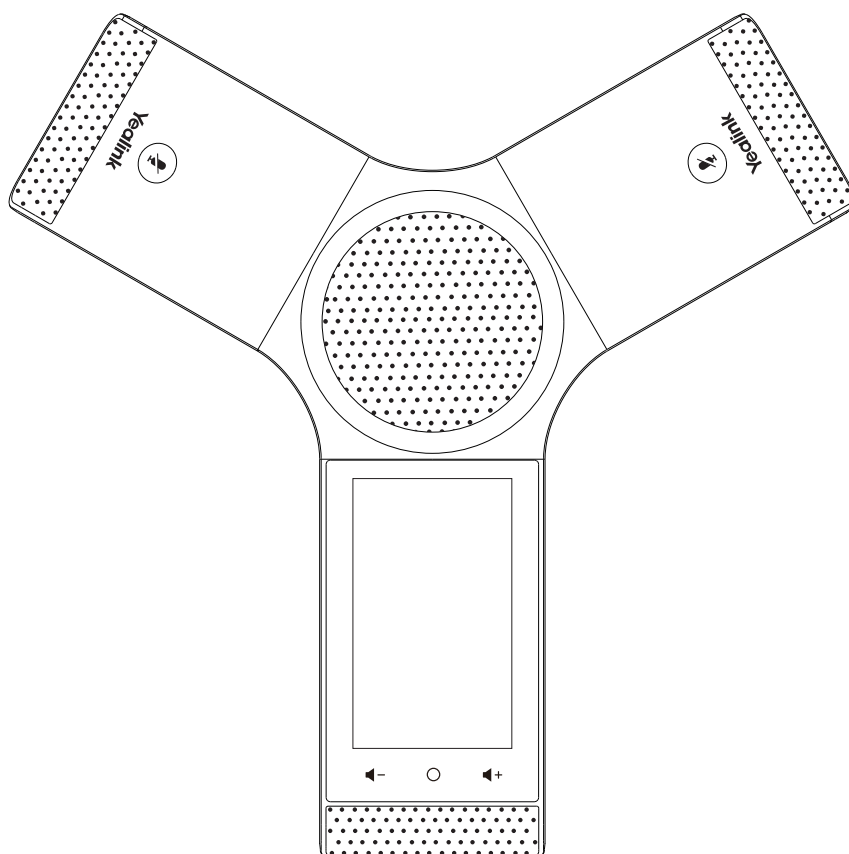

English | 简体中文

### Quick Start Guide (V80.26)



## Table of Contents

English .....	1
简体中文 .....	9

# Packaging Contents

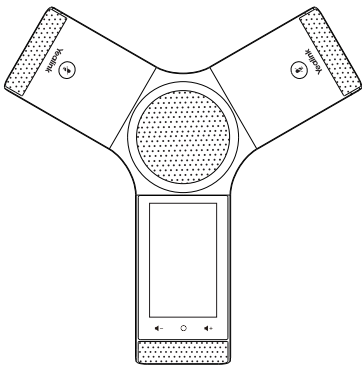

IP Phone

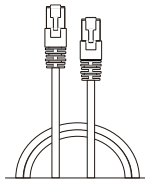

Ethernet Cable  
(7.5m CAT5E UTP cable)

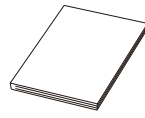

Quick Start Guide

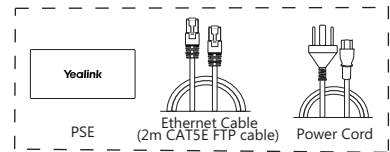

PoE Adapter  
(Optional)

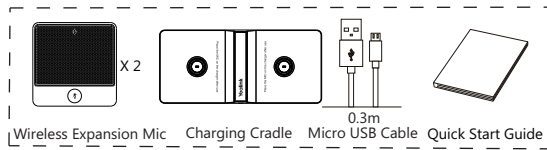

CP Wireless Expansion Mic CPW90  
(Optional)

Note: The CPW90 helps you to expand the audio range of the IP phone. For more information, refer to Yealink CPW90 Quick Start Guide. We recommend that you use the accessories provided or approved by Yealink. The use of unapproved third-party accessories may result in reduced performance.

# Assembling the Phone

## 1a. Connect the power and wired network.

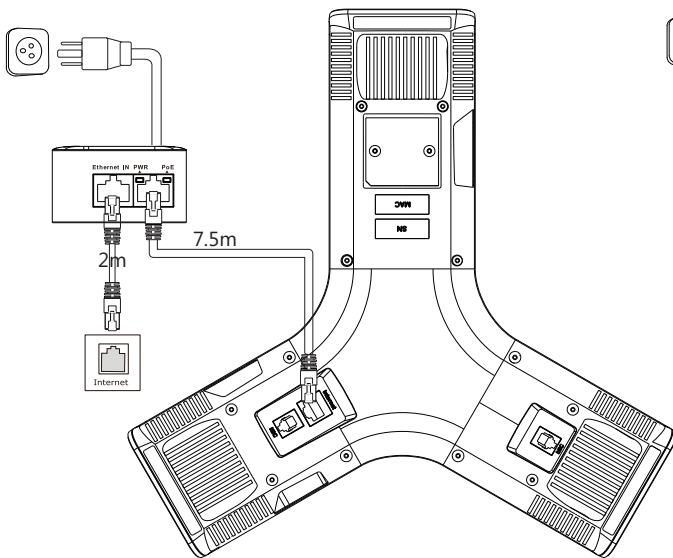

## 1b. Connect the power and wireless network.

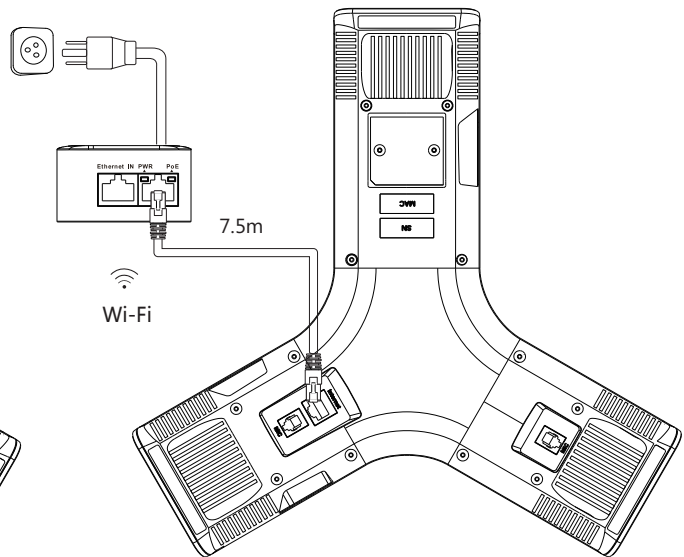

Refer to **Wireless Network Connection** mentioned below in **Configuring Your Phone** for more information.

Note: The IP phone should be used with Yealink original PoE adapter (54V/0.56A) only. The use of the third-party PoE adapter may cause the damage to the phone. The cable should be replaced at once if its skin is broken.

**2. Connect the optional PC.**

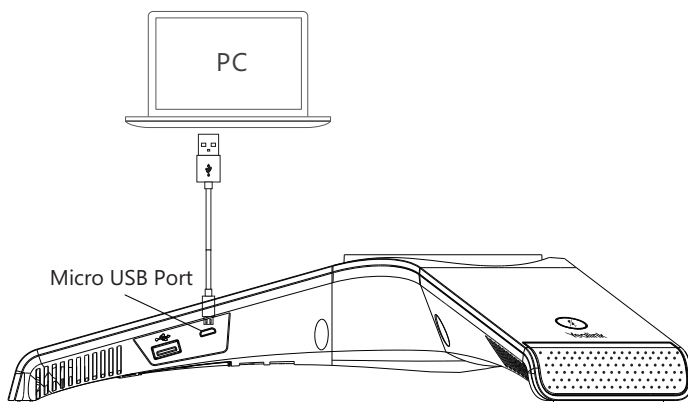

**3. Connect the optional external speaker.**

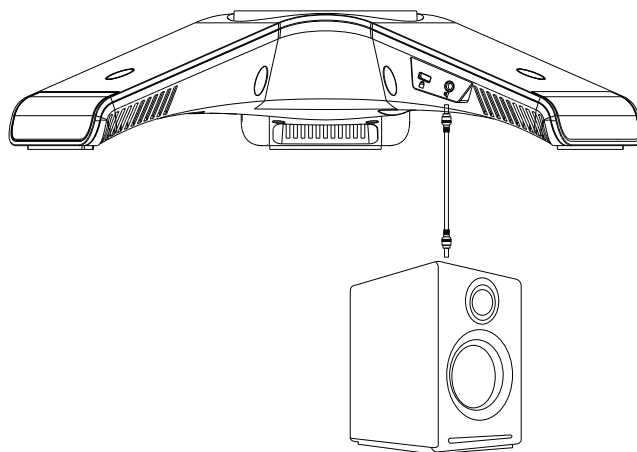

**4. Connect the optional USB flash drive.**

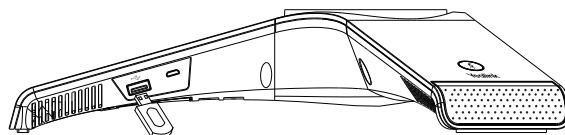

## Startup

After the IP phone is connected to the network and supplied with power, it automatically begins the initialization process. After startup, the phone is ready for use. You can configure the phone via web user interface or phone user interface.



# Hardware Component Instructions

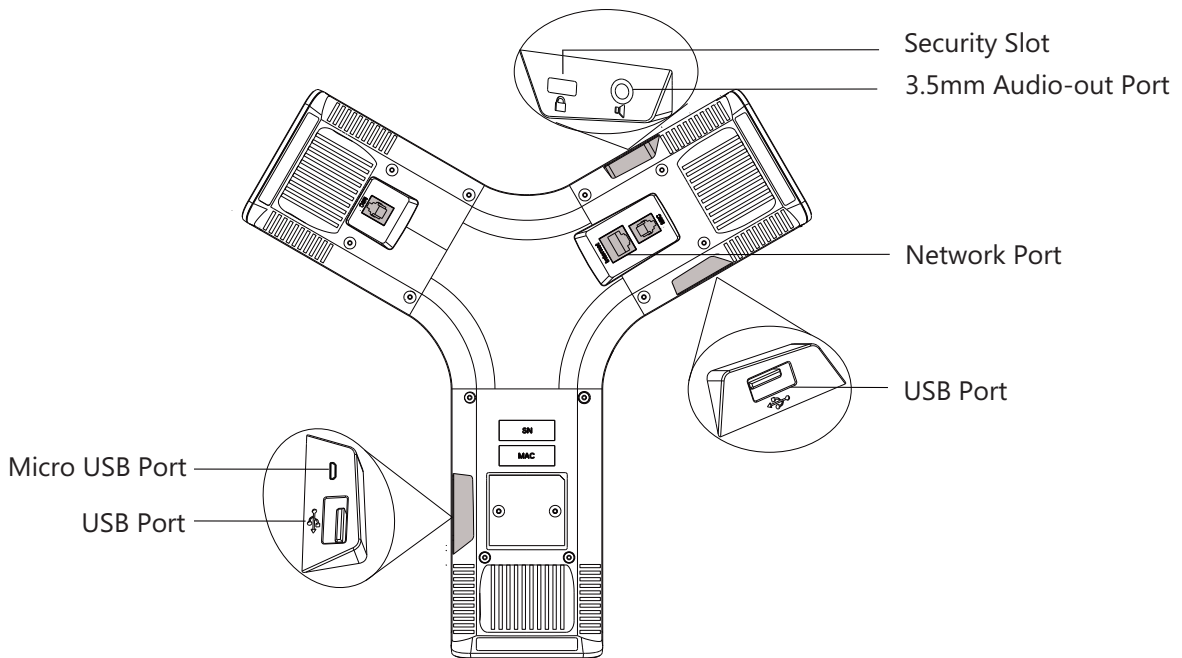
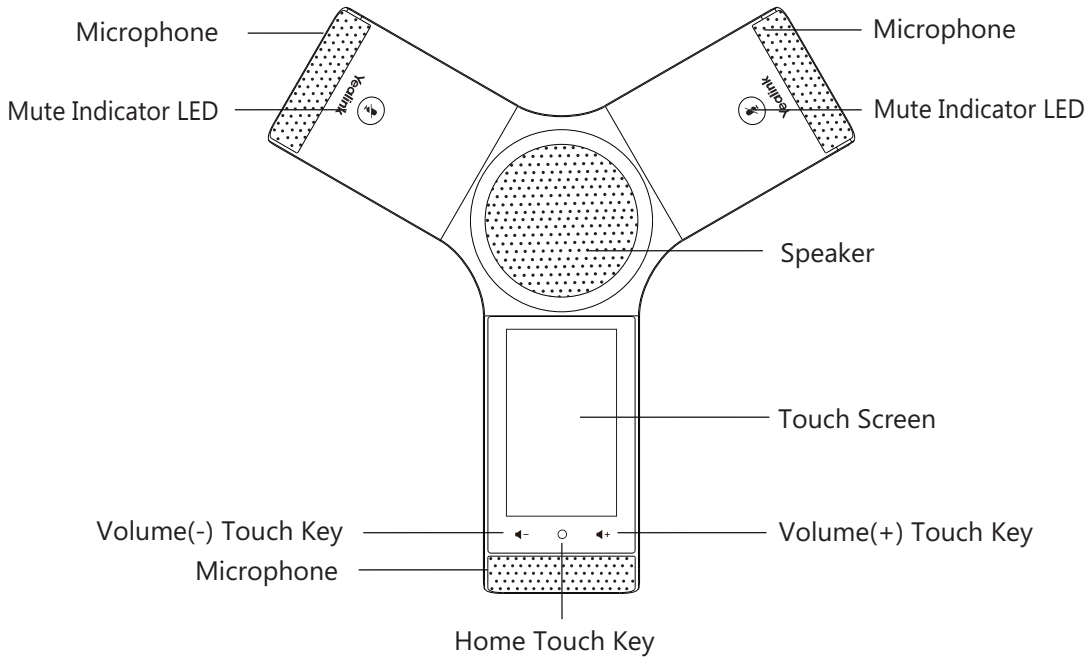

# Using the Touch Screen

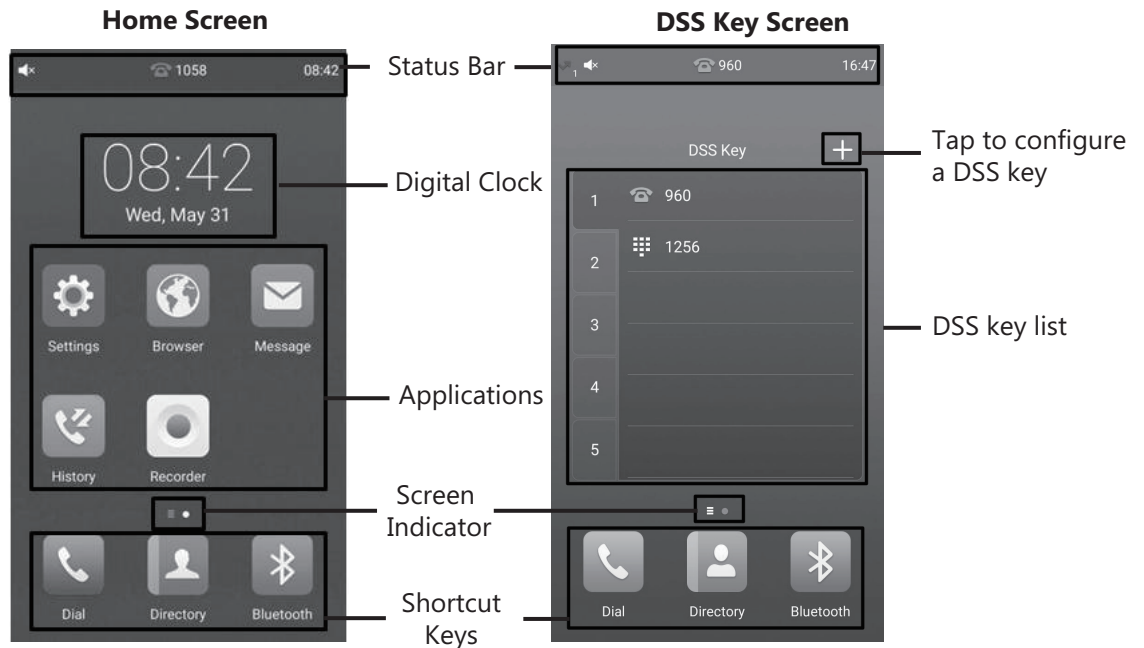

Swipe left or right to switch between two idle screens.

## Control Center and Notification Center

Swipe down from the top of the screen to enter the control center and the notification center.



## Entering and Updating Data

### To use onscreen keyboard:

1. Tap the input field, the onscreen keyboard displays on the touch screen.

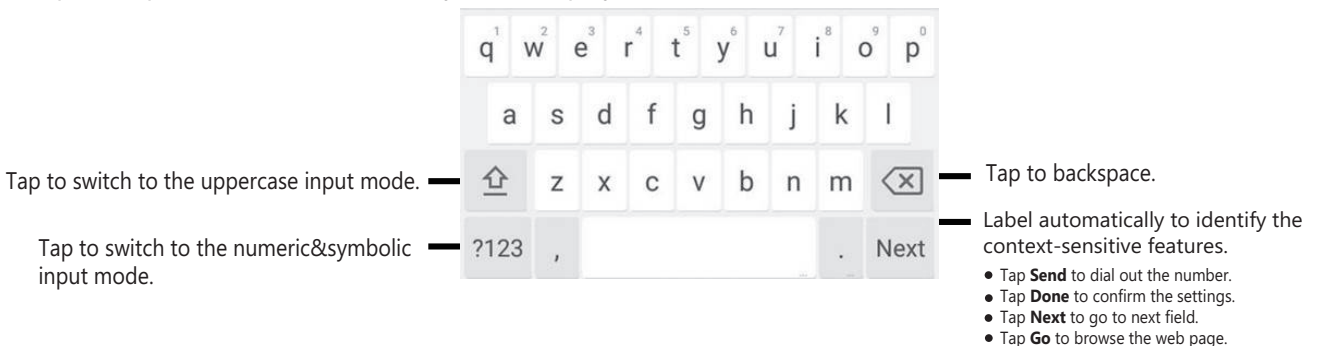

# Configuring Your Phone

## Configuring via web user interface

### Accessing the web user interface:

1. Tap **Settings**->**General** to obtain the IP address of the phone.
2. Open a web browser on your computer, enter the IP address into the address bar (e.g., "http://192.168.0.10" or "192.168.0.10"), and then press **Enter**.
3. Enter the user name (default: admin) and password (default: admin) in the login page and click **Confirm**.

### Network Settings: Click on **Network**->**Basic**->**IPv4 Config**

You can configure the network settings in the following ways:

**DHCP:** By default, the phone attempts to contact a DHCP server in your network to obtain its valid network settings, for example, IP address, subnet mask, gateway address and DNS address.

**Static IP Address:** If the phone cannot contact a DHCP server for any reason, you need to configure IP address, subnet mask, gateway address, primary DNS address and secondary DNS address for the phone manually.

**PPPoE:** If you are using an xDSL modem, you can connect your phone to the Internet via PPPoE mode. Contact the ITSP for the PPPoE user name and password.

Note: The IP phone also supports IPv6, but IPv6 is disabled by default.

The wrong network settings may result in inaccessibility of your phone and may have an impact on the network performance. Contact your system administrator for more information.

### Account Settings: Click on **Account**->**Register**.

#### Parameters of the account:

Register Status:	It shows the register status of the current account.
Line Active:	You can select Enabled/Disabled to enable/disable the account.
Label:	It is shown on the touch screen to identify the account.
Display Name:	It is shown as Caller ID when placing a call.
Register Name:	It is an authenticated ID for authentication provided by ITSP (required).
User Name:	It is provided by ITSP for registration (required).
Password:	It is provided by ITSP for registration (required).
Server Host:	It is provided by ITSP for registration (required).

#### Register status icons on the touch screen:

 (Green) Registered     (Gray) Register Failed     (Green and Flashing) Registering

Note: Check with your system administrator if any error appears during the registration process or a specific configuration is required for your registration.

## Configuring via phone user interface

### Network Settings:

1. Tap **Settings**->**Advanced** (default password: admin) ->**Network**->**WAN Port/VLAN/Webserver Type/802.1x/VPN/LLDP/CDP/NAT** to configure the network.

### Wireless Network Connection:

1. Tap **Settings** from the Home screen.
2. Tap **Wi-Fi** from the **Basic** block.
3. Turn **Wi-Fi** on.  
The button turns to green, and the phone will automatically search for available wireless networks in your area.
4. Tap an available wireless network from the list of networks.
5. If the network is secure, enter its password in the **Password** field.
6. Tap **Connect** to connect to the wireless network.

### Account Settings:

1. Tap **Settings**->**Advanced** (default password: admin) ->**Accounts** to configure the account.



# Basic Call Features

## Placing a Call

You can place a call by manually entering a phone number, or to a contact from **Directory** or **History**.

From the Home screen, do one of the following:

- Tap **Dial**, enter the phone number, and then tap **Send**.
- Tap **Directory/History**, and then tap a desired entry to dial out.

## Answering a Call

Tap **Answer**.

## Ending a Call

Tap **EndCall**.

## Call Mute and Unmute

### To mute a call:

Tap **Mute** on the touch screen or tap  during a call. The mute key LED illuminates solid red.

### To unmute a call:

Tap **Mute** on the touch screen or tap  again to unmute the call. The mute key LED illuminates solid green.

## Call Hold and Resume

### To hold a call:

Tap **More->Hold** during a call.



### To resume a call:

Tap **More->Resume** or tap  during a call.

## Local Conference

You can host a five-way conference with up to four parties.

### To initiate a conference:

1. Tap  during a call.
2. Tap **Call multiple members? Click here>>**.
3. Enter a phone number, and then tap **Add members**.  
You can also select a contact from **Directory** or **History** to join into a conference.
4. Repeat the step 3 to join more members.
5. Tap  to call the added members.  
The members are added to the conference after answering.

### To join two calls into conference:

Tap  on the Calls screen.

### To manage the individual participant:





Tap the avatar of desired participant, do the following:

- Tap **Far Mute** to mute the participant. The muted participant can hear everyone, but no one can hear the muted participant.
- Tap **Hold/Resume** to hold/resume the participant.
- Tap **Split** to split the participant from the conference.
- Tap **Remove** to remove the participant from the conference.
- Tap **Detail** to view the participant information.

## Call Recording

You can record audio calls in the phone itself or onto a USB flash drive (if connected).

### To record audio calls:

1. Tap  during a call or conference.
2. If a USB flash drive is connected, select where to save your recordings.  
The record icon  changes to , the record duration and a mark flag appear on the touch screen.
3. If you want to make a mark during the recording, tap **Mark** once, then the LCD screen will show Mark+1, meaning that there is one mark in this recording.
4. Tap . The recording is saved.

If you end a call or conference during recording, the recordings will be saved automatically when ending the call.

## Call Forward

You can forward an incoming call to a contact, or forward all incoming calls to a contact.

**To forward an incoming call to a contact:**

1. Tap  from the Incoming Call screen.
2. Enter the number you want to forward to.  
You can also select a contact from **Directory** or **History**. The call is forwarded to the contact directly.
3. Tap **FWD**.

**To forward all incoming calls to a contact:**

1. Tap **Settings** from the Home screen.
2. Select **Call Forward** from the **Features** block.
3. Select the desired forwarding type:
  - Always Forward**----Incoming calls are forwarded unconditionally.
  - Busy Forward**----Incoming calls are forwarded when the phone is busy.
  - No Answer Forward**----Incoming calls are forwarded if not answered after a period of time.
4. Turn on the desired forwarding type.
5. Enter the number you want to forward to in the **Forward To** field.
6. If you select **No Answer Forward**, tap the **After Ring Time** field to select a desired ring time to wait before forwarding.
7. Tap  to accept the change.

**Call Transfer**

You can transfer a call in the following ways:

**Blind Transfer**

1. Tap **More->Transfer** during a call. The call is placed on hold.
2. Enter the number you want to transfer to. You can also select a contact you want to transfer to from **Directory** or **History**.
3. Tap **Transfer**.
4. Tap **Transfer** from the prompt box.

**Semi-Attended Transfer**



1. Tap **More->Transfer** during a call. The call is placed on hold.
2. Enter the number you want to transfer to.
3. Tap **Transfer**.
4. Tap **Send** from the prompt box.
5. Tap **Transfer** when you hear the ring-back tone.

**Attended Transfer**



1. Tap **More->Transfer** during a call. The call is placed on hold.
2. Enter the number you want to transfer to.
3. Tap **Transfer**.
4. Tap **Send** from the prompt box.
5. Tap **Transfer** when the second party answers.

## Customizing Your Phone

**Local Directory****To add a contact:**

1. Tap **Directory** from the Home screen.
2. Tap  .
3. Enter a unique contact name in the **Name** field and contact numbers in the corresponding fields.
4. Tap  to accept the change.

**To edit a contact:**

1. Tap **Directory** from the Home screen.
2. Tap  after the desired contact.
3. Edit the contact information.
4. Tap  to accept the change.

**To delete a contact:**

1. Tap **Directory** from the Home screen.
2. Tap  after the desired contact and then tap **Delete**.
3. Tap **OK** when the touch screen prompts "Delete selected item?".

Note: You can add contacts from call history easily. For more information, refer to **Call History**.

---

## Call History

1. Tap **History** from the Home screen.
2. Tap **All Local Calls**, and then select the desired call history list.
3. Drag up and down to scroll.
4. Tap ⓘ after the desired entry, and then you can do the following:
  - Tap **Send** to place a call.
  - Tap **Place on dsskey** to assign a speed dial DSS key for the entry.
  - Tap **Add** to add the entry to the local directory.
  - Tap **Edit before calling** to edit the phone number of the entry before placing a call.
  - Tap **Blacklist** to add the entry to the blacklist.
  - Tap **Delete** to delete the entry from the list.

## Volume Adjustment

- Tap ◀– or ▶+ on the IP phone during a call to adjust the receiver volume.
- Tap ◀– or ▶+ on the IP phone when the phone is idle or ringing to adjust the ringer volume.
- Tap ◀– or ▶+ to adjust the media volume in the corresponding screen.

# 包装清单

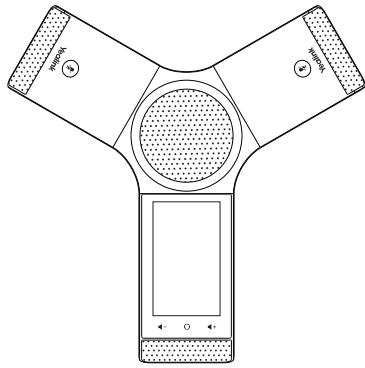

IP会议电话

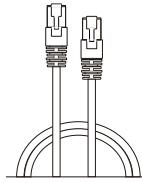

7.5米  
UTP超五类以太网线

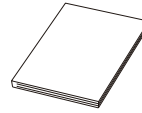

快速入门指南

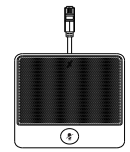

CP有线扩展麦  
(可选)

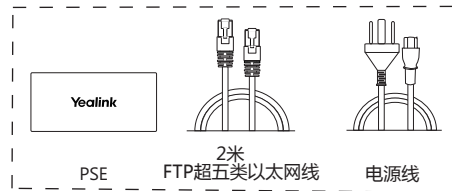

PoE电源  
(可选)

说明：我们推荐使用由Yealink提供或经Yealink认可的配件，使用未经认可的第三方配件可能会导致性能的下降。

# 安装电话

## 1a. 连接电源和有선网线：

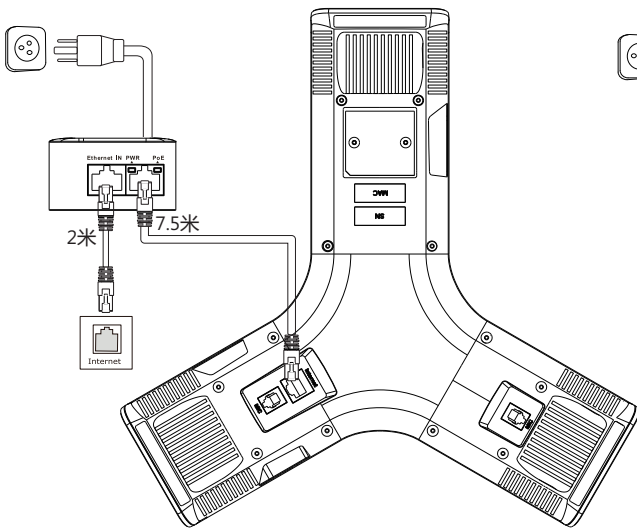

## 1b. 连接电源和无线网线：

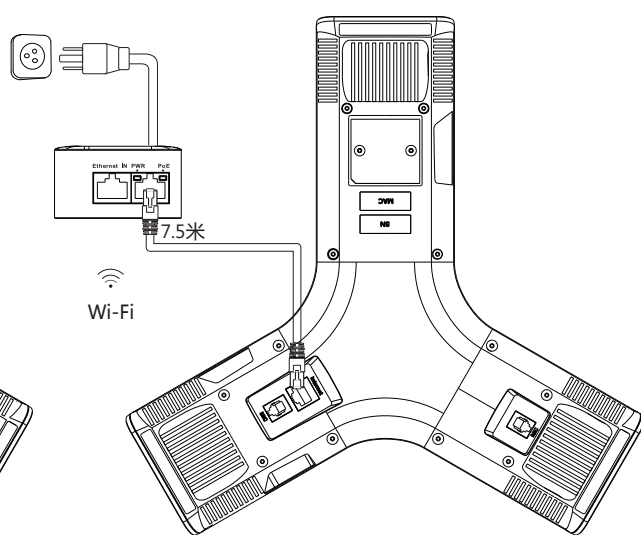

想要了解更多信息，请参考配置话机章节中的无线网络连接。

说明：我们要求使用Yealink原装PoE电源（54V/0.56A），使用第三方电源可能会导致话机损坏。  
如果电源线或网线破皮，请立即更换。

2. 连接CP有线扩展麦CPE90（可选）：

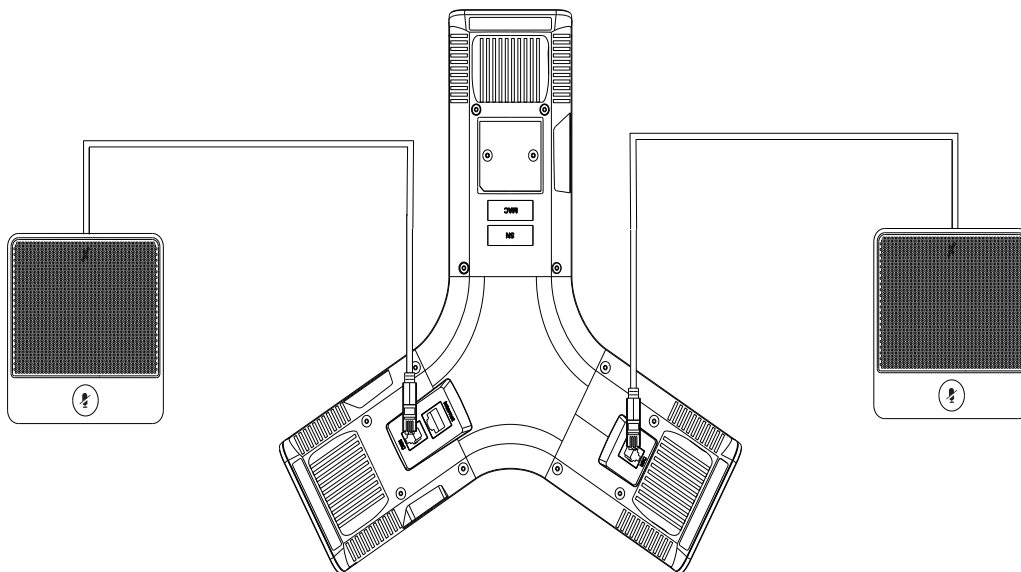

3. 连接PC（可选）：

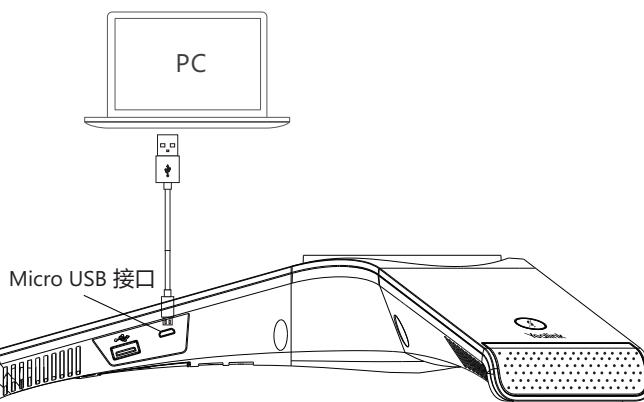

4. 连接外置音箱（可选）：

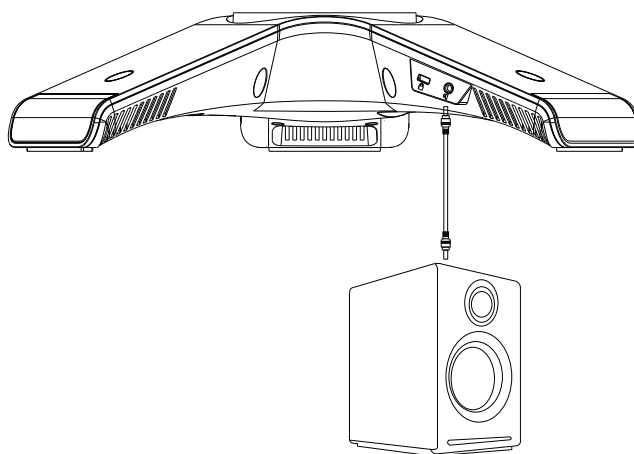

5. 连接U盘（可选）：

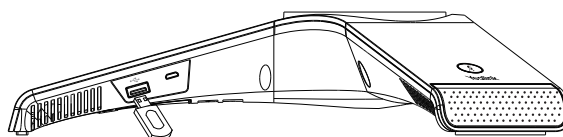

# 启动

在话机连接上网络和电源后，话机自动启动。启动完成后，话机能正常使用。你可以通过Web界面或话机界面配置话机。



# 硬件介绍

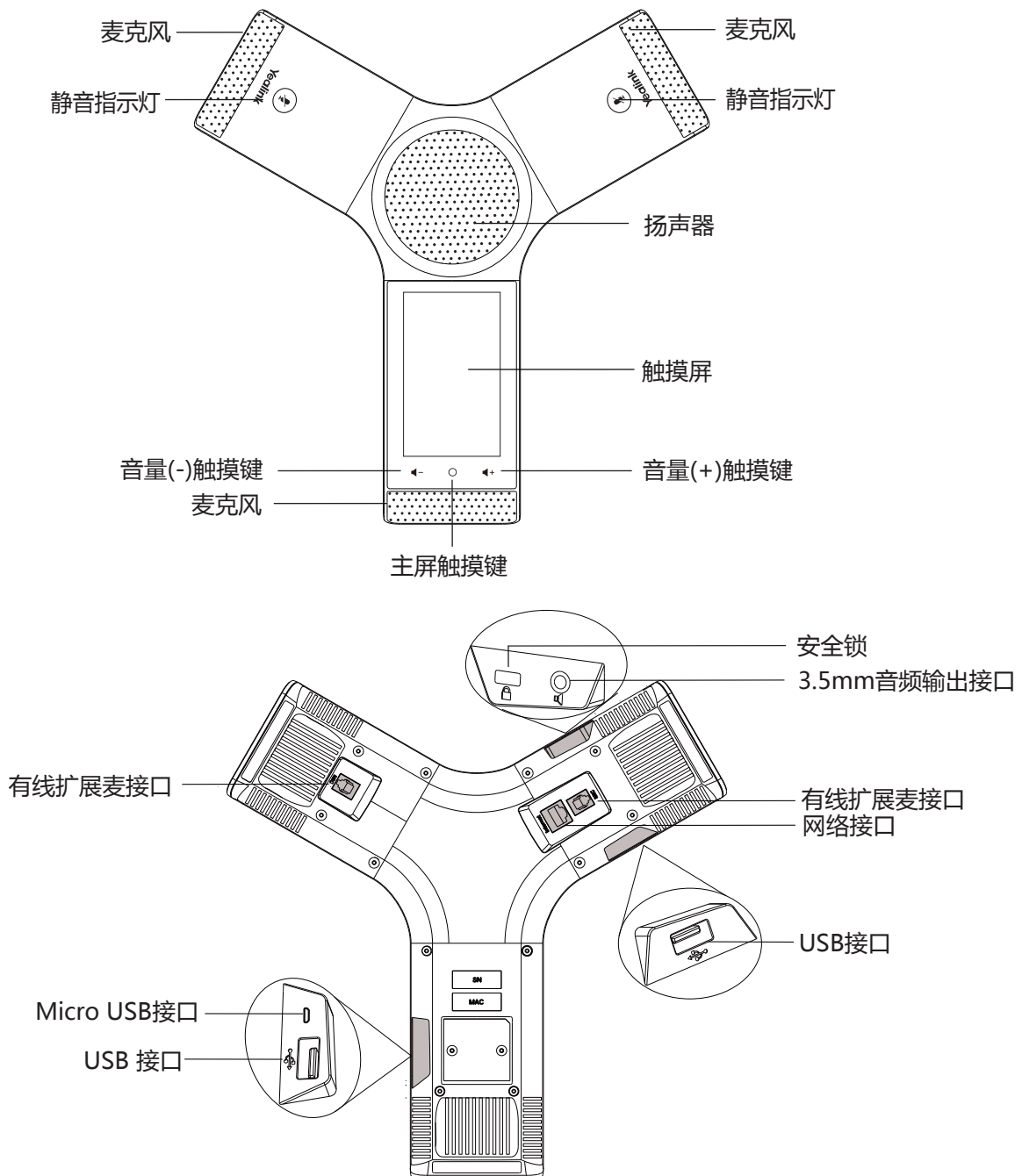

# 话机使用

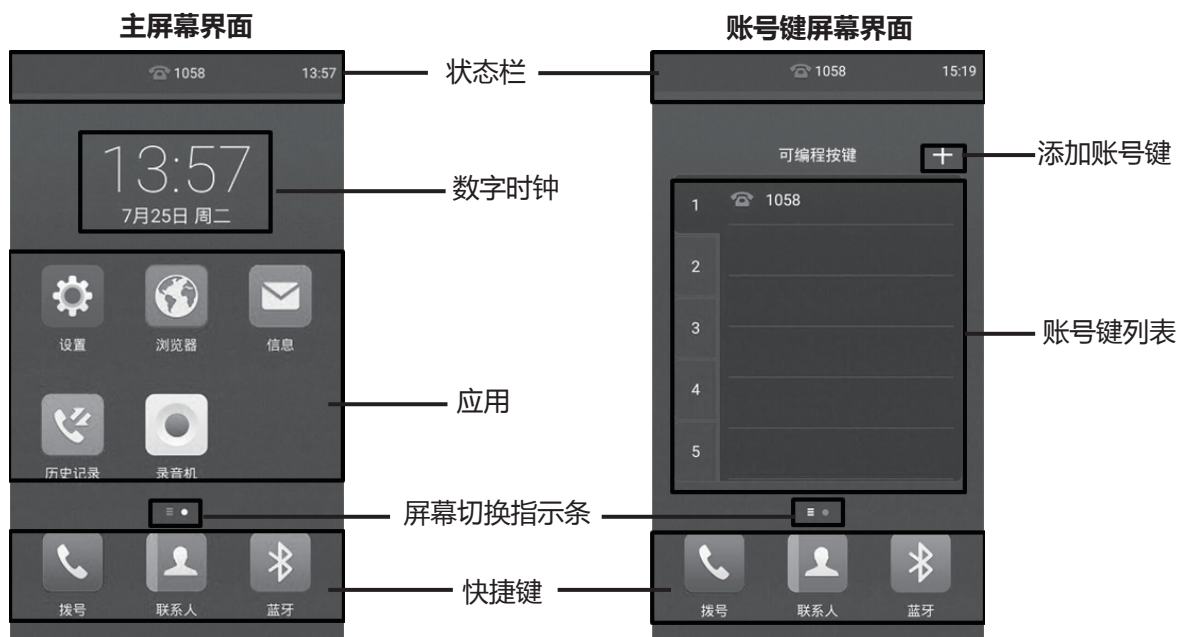

向左或向右滑动屏幕，在两个屏幕界面间进行切换。

## 控制中心和通知中心：

从触摸屏顶部向下滑动，进入控制中心和通知中心。



## 输入或更新数据：

### 使用触摸屏上的键盘：

1. 按要编辑的区域，屏幕键盘将会显示在触摸屏上：

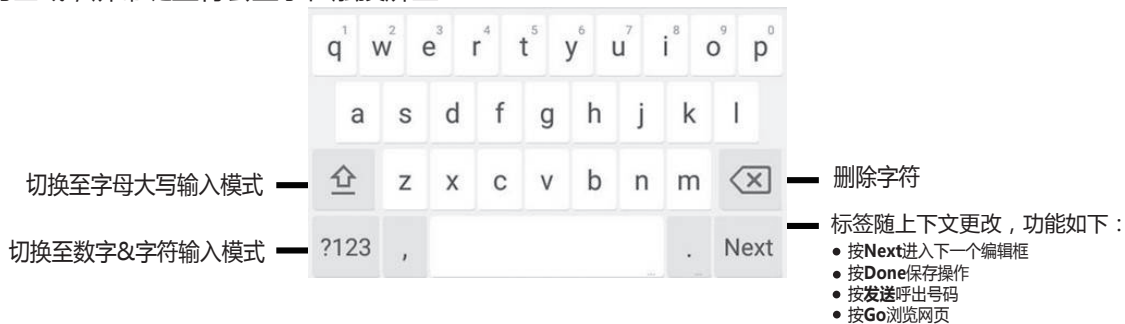

# 配置话机

## 通过Web界面配置话机

### 访问Web界面：

- 1.在话机空闲时，按**设置**->**常规**查看话机的IP地址。
- 2.打开电脑上的网页浏览器，在地址栏里输入话机的IP地址（例如：http://192.168.0.10或192.168.0.10），按**Enter**键。
- 3.在登录界面的用户名输入框中输入管理员用户名“admin”，密码输入框中输入管理员密码“admin”，点击**提交**。

### 网络配置：点击**网络配置**->**基础**->**IPv4配置**

你可以通过以下方式配置网络：

**DHCP**：话机默认通过DHCP服务器获取网络配置。例如：IP地址、子网掩码、网关和DNS服务器。

**静态IP地址**：如果话机无法通过DHCP服务器获取网络配置，你需要手动配置IP地址、子网掩码、网关、首选DNS服务器和备选DNS服务器。

**PPPoE**：如果话机使用xDSL调制解调器，则通过PPPoE方式连接到网络。有关用户名及密码的具体信息，请咨询网络技术服务提供商。

**说明**：话机的网络配置也支持IPv6协议，但IPv6默认是关闭的。

错误的网络设置会导致网络不可用，也可能对网络的性能造成影响。请咨询你的系统管理员了解更多信息。

### 账号配置：点击**账号**->**注册**

#### 账号参数：

- |         |                    |
|---------|--------------------|
| 注册状态：   | 显示当前账号的注册状态。       |
| 线路激活：   | 启用/禁用账号。           |
| 标签：     | 显示在触摸屏上的账号标签。      |
| 显示名称：   | 呼出号码时，显示在对方话机上的名称。 |
| 注册名称：   | 由网络技术服务提供商提供（必填）。  |
| 用户名称：   | 由网络技术服务提供商提供（必填）。  |
| 密码：     | 由网络技术服务提供商提供（必填）。  |
| SIP服务器： | 由网络技术服务提供商提供（必填）。  |

#### 话机触摸屏显示账号注册状态的图标：

 (绿色) 注册上

 (灰色) 注册失败

 (绿色闪烁) 注册中

**说明**：如果注册失败，请咨询你的系统管理员。

## 通过话机界面配置话机

### 网络配置：

在话机空闲时，按**设置**->**高级设置**（默认密码：admin）->**网络**->**WAN端口/VLAN/网络服务器/802.1x/VPN/LLDP/CDP/NAT**。

### 无线网络连接：

- 1.按主屏幕上的**设置**。
- 2.按**基础设置**区域中的**无线网络**。
- 3.打开**Wi-Fi**开关。  
话机将自动搜索附近可用的Wi-Fi。
- 4.从可用的网络列表中，选择一个Wi-Fi。
- 5.如果要连接一个加密的网络，在**密码**区域中输入密码。
- 6.按**连接**。

### 账号配置：

在话机空闲时，按**设置**->**高级设置**（默认密码：admin）->**账号**



# 基本功能

## 拨打电话

你可以在话机上直接呼出电话号码。你也可以从**联系人**或**历史记录**中呼叫相应的联系人。

在主屏幕界面上，使用下述任意一种方式：

- 按**拨号**，输入相应的电话号码，然后按**发送**。
- 按**联系人**或**历史记录**，然后按相应的条目进行呼叫。

## 接听电话

按**应答**。

## 结束通话

按**结束通话**。

## 静音或取消静音

### 开启通话静音：

在通话中，接触摸屏上的**静音**或。静音键的LED灯红色常亮。

### 取消通话静音：

再次接触摸屏上的**静音**或。静音键的LED灯绿色常亮。

## 通话保持和恢复

### 通话保持：

在通话中，按**更多**->**保持**。



### 恢复通话：

按**更多**->**恢复**或按。

## 会议

话机最多支持五方会议。

### 创建会议：

1. 在通话中，按。
2. 按**呼叫多个成员？点击这里**》。
3. 输入相应电话号码，然后按**邀请**。  
你也可以从**联系人/历史记录**中选择联系人加入会议。
4. 重复步骤3，添加更多成员。
5. 按 呼叫所有已添加的成员。  
成员接听来电后，自动加入会议。

### 将两路通话合并成一路会议通话：

在通话界面，按。

### 会议成员管理：





按相应成员的头像，可以进行以下操作：

- 按**对端静音**禁止该成员发言。该成员可以听到会议内容，但是其他成员无法听到该成员的声音。
- 按**保持**使该成员的通话处于保持状态。按**恢复**恢复通话。
- 按**拆分**将与该成员的通话拆分成一路独立的通话。
- 按**移除**将该成员移除。
- 按**详情**查看成员信息。

## 通话录音

你可以录制音频通话，然后将录音文件保存在话机或U盘上。

### 录制音频通话：

1. 在通话中，按。
2. 如果连接了U盘，选择保存录音的位置。  
录音图标 变成，触摸屏显示录制时间和**标记**标识。
3. 录音过程中，按一下**标记**可以设置标记。触摸屏显示**标记+1**，表示当前录音中设置了一个标记。
4. 按。录音已保存。

如果你在通话中挂断了电话，录音将在通话结束时自动保存。

## 呼叫转移

你可以转移当前来电，或转移所有来电。

### 转移当前来电：

1. 在来电界面，按 。
2. 输入你希望转移到的号码。  
你也可以从**联系人**或**历史记录**中选择一个联系人。来电将直接转移到该联系人。
3. 按**转移**。

### 转移所有来电：

1. 按主屏幕上的**设置**。
2. 在功能区域中选择**呼叫转移**。
3. 选择呼叫转移的类型：
  - 无条件转移**----话机的所有来电，将被无条件自动转移到预先指定的号码。
  - 遇忙转移**----当话机忙时，来电将被转移到预先指定的号码。
  - 无应答转移**----当话机在指定的响铃时间内无应答时，来电将被转移到预先指定的号码。
4. 打开相应的开关。
5. 输入你希望转移到的号码。
6. 如果选择**无应答转移**，在**响铃时长**区域选择转移前等待的响铃时间。
7. 按  保存操作。

### 通话转接

你可以使用下述三种方式将通话转接到另一方：

#### 盲转

1. 在通话中，按**更多**->**通话转接**。当前的通话被保持。
2. 输入你要转接到的号码。你也可以从**联系人/历史记录**中选择要转接到的联系人。
3. 按**通话转接**。
4. 在提示框中，按**通话转接**。

#### 半咨询转

1. 在通话中，按**更多**->**通话转接**。当前的通话被保持。
2. 输入你要转接到的号码。
3. 按**通话转接**。
4. 在提示框中，按**发送**。
5. 在听到回铃音后，按**通话转接**。



#### 咨询转

1. 在通话中，按**更多**->**通话转接**。当前的通话被保持。
2. 输入你要转接到的号码。
3. 按**通话转接**。
4. 在提示框中，按**发送**。
5. 在对方接听来电并进行咨询后，按**通话转接**。



## 自定义话机

### 联系人

#### 添加联系人：

1. 按主屏幕上的**联系人**。
2. 按 。
3. 在姓名区域输入联系人姓名，在相应的区域输入联系人号码。
4. 按  保存操作。

#### 编辑联系人：

1. 按主屏幕上的**联系人**。
2. 按联系人后的 。
3. 编辑联系人信息。
4. 按  保存操作。

#### 删除联系人：

1. 按主屏幕上的**联系人**。
2. 按联系人后的 ，然后按**删除**。
3. 触摸屏弹出“**删除选中条目？**”，按**确定**删除联系人。

**说明：**你可以从历史记录中添加联系人。了解更多信息，请参考**历史记录**章节。

## 历史记录

1. 按主屏幕上的**历史记录**。
2. 按**本地通话记录**，然后选择相应的通话记录列表。
3. 按住向上或向下拖拽通话记录。
4. 按对应记录后的 ⓘ，你可以进行如下操作：
  - 按**发送**拨打电话。
  - 按**放到扩展按键**为该条目设置一个快速拨号键。
  - 按**添加**添加条目到本地联系人。
  - 按**呼叫前编辑**编辑条目的号码，也可以按发送呼出号码。
  - 按**黑名单**添加条目到黑名单。
  - 按**删除**删除选中的条目。

## 音量调节

- 在通话中，按 ◀- 或 ▶+ 调节接收音量。
- 在话机空闲或响铃时，按 ◀- 或 ▶+ 调节响铃的音量。
- 在媒体播放界面，按 ◀- 或 ▶+ 调节媒体播放的音量。

## 使用CP有线扩展麦CPE90

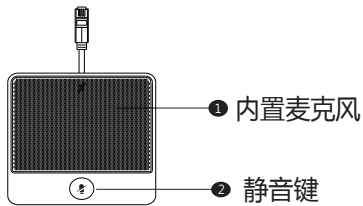

### 连接有线扩展麦时，开启通话静音：

1. 在通话中，按有线扩展麦上的 ⓘ。  
静音键的LED灯红色常亮。

### 取消通话静音：

1. 再次按 ⓘ。

## About Yealink

Yealink (Stock Code: 300628) is a global leading unified communication (UC) terminal solution provider that primarily offers video conferencing systems and voice communication solutions. Founded in 2001, Yealink leverages its independent research and development and innovation to pursue its core mission: "Easy collaboration, high productivity." The company's high-quality UC terminal solutions enhance the work efficiency and competitive advantages of its customers in over 100 countries. Yealink is the world's second-largest SIP phone provider and is number one in the China market.

## Technical Support

Visit Yealink WIKI (<http://support.yealink.com/>) for the latest firmware, guides, FAQ, Product documents, and more. For better service, we sincerely recommend you to use Yealink Ticketing system (<https://ticket.yealink.com>) to submit all your technical issues.



CP960 - EN+CN

YEALINK(XIAMEN) NETWORK TECHNOLOGY CO.,LTD.  
Web: [www.yealink.com](http://www.yealink.com)  
Addr: 309, 3th Floor, No.16, Yun Ding North Road, Huli  
District, Xiamen City, Fujian, P.R. China  
Copyright©2017 YEALINK(XIAMEN) NETWORK  
TECHNOLOGY CO.,LTD.All rights reserved.